

MACHEREY-NAGEL



Chromatography



MACHEREY-NAGEL



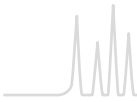

	Contents	4
	Solid phase extraction	8
	Sample filtration	84
	Vials and caps	100
	Liquid chromatography	142
	Thin layer chromatography	272
	Gas chromatography	306
	Appendices	379

MACHEREY-NAGEL – About us

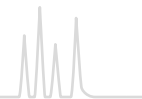

Quality since 1911

Since 1911 MACHEREY-NAGEL stands for high quality, innovation and reliability in chemical and biomolecular analysis. Friendly expert advice for our highly valued customers as well as outstanding product quality have been the cornerstones of our success for more than 100 years. MACHEREY-NAGEL is

a family-owned company run by the fourth generation. As one of today's leading manufacturers of products for analytical chemistry and life science we offer a broad range of products for Filtration, Rapid Tests, Water Analysis, Chromatography and Bioanalysis.

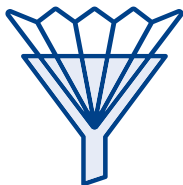

Filtration



Rapid Tests



Water Analysis

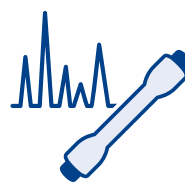

Chromatography



Bioanalysis

MACHEREY-NAGEL – Worldwide

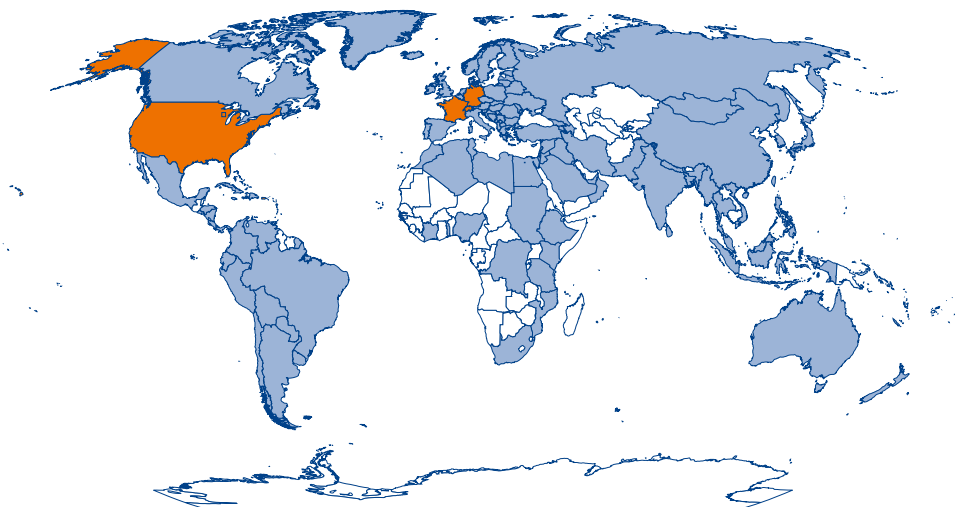

Watch our company video on YouTube.

Our customers can count on competent and reliable service all over the world.

- Headquarters and manufacturing site in Düren (Germany), further location in Oensingen (Switzerland)
- Globally operating network of qualified and specially trained distributors in more than 150 countries
- Branches in France, Switzerland and the United States with dedicated and expert staff

For a complete list of branches and authorized distributors, see www.mn-net.com/distributors

Pioneer in Chromatography



MACHEREY-NAGEL Chromatography – Complete solutions for your analysis

MACHEREY-NAGEL has grown from a pioneer in chromatography to a full-range supplier of laboratory consumables. We supply laboratories all over the world with HPLC, GC and SPE columns, TLC plates and sheets, syringe filters or suitable vials and caps. Our philosophy includes personal and competent

support, as well as outstanding product quality. We have the demand to fulfill our customer's individual needs and offer optimal and reliable solutions for your lab work in method development and routine analysis.

MACHEREY-NAGEL as a partner

- Competent and individual service
- More than 60 years of expertise in manufacturing of chromatographic adsorbents
- Comprehensive product portfolio covering all areas of chromatography consumables
- You can find MACHEREY-NAGEL also on exhibitions www.mn-net.com/tradeshows

MN on the Internet – Chromatography services



Safety data sheets (SDS)

For our Chromatography products we provide safety data sheets (SDS) in conformity with REACH regulations.

Certificates of analysis (CoA)

Analysis certificates for our products can be downloaded online.

USP-Listing

Overview about standard HPLC and GC phases according to USP classification.

Chromatography downloads

In the download overview you can find comprehensive information and documents including catalogues, brochures, flyers, application notes and posters.

E-Training – Chromatography

Find useful information, videos and tips on the use and application of our products.

www.mn-net.com/e-training-chromatography
and more...

VialFinder

Translation tool – Easy selection by updated cross references of vials and caps by supplier and/or item number. www.mn-net.com/vialfinder

CHROMAFIL Finder

Your easy changeover to syringe filters from MACHEREY-NAGEL. Easy selection by manufacturer and/or item number. www.mn-net.com/chromafilfinder

Application database for chromatography

Online application database with more than 3000 applications for HPLC, GC, TLC and SPE. www.chromaappdb.mn-net.com

For more information about MACHEREY-NAGEL, our products and services, visit us online under www.mn-net.com



A company with tradition and future

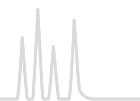

Solid phase extraction

Basics.....	10
CHROMABOND® hardware	14
CHROMABOND® summary of MN phases.....	16
CHROMABOND® modern polymeric phases	18
CHROMABOND® polymer phases · others	29
CHROMABOND® reversed phases	33
CHROMABOND® normal phases.....	38
CHROMABOND® ion exchangers based on silica	44
Special phases · pharmac. applications	47
Special phases · environmental analysis.....	50
Special phases · food analysis	56
Special phases · others.....	62
SPE vacuum manifolds and accessories	66
Empty columns and accessories.....	68
High throughput SPE	69
Flash chromatography	72
CHROMABOND® Flash RS solutions for Isco® Flash instruments.....	78
CHROMABOND® Flash BT solutions for Biotage® Flash instruments	80
CHROMABOND® Flash connecting kits	82
Flash glass columns and accessories	83



Sample filtration

Basics.....	86
Selection guide for syringe filters	88
CHROMAFIL® combi filters	89
CHROMAFIL® syringe filters.....	90
Chemical compatibility of CHROMAFIL®	97
CHROMAFIL® filtration cartridges · MULTI 96.....	98



Vials and caps

Basics.....	102
Crimp neck vials and caps N 8.....	106
Screw neck vials and caps N 8	107
Screw neck vials and caps N 9	109
Screw neck vials and caps N 10	113
Crimp neck vials and caps N 11.....	114

Snap ring vials and caps N 11.....	119
Crimp neck vials and caps N 13.....	123
Screw neck vials and caps N 13	124
Special vials and caps.....	125
Screw neck vials for storage of liquid samples.....	125
Snap cap vials for storage of powdery samples	128
Shell vials N 8	129
Screw neck vials / magnetic screw caps N 18	130
Crimp neck vials and caps N 20.....	132
Screw neck vials and caps N 24	137
Containers / Vial racks	139
Crimping tools	140



Liquid chromatography

Basics.....	144
USP listing	148
NUCLEODUR® high purity silica for HPLC.....	150
NUCLEODUR® for UHPLC.....	151
NUCLEODUR® phase overview	152
NUCLEODUR® columns	158
NUCLEOSHELL® core-shell silica for HPLC	192
NUCLEOSHELL® phase overview	198
NUCLEOSHELL® columns.....	200
NUCLEOSIL® standard silica for HPLC	217
NUCLEOSIL® phase overview.....	218
NUCLEOSIL® columns.....	220
Phase overview for special separations	231
HPLC columns for environmental analyses.....	232
HPLC columns for enantiomer separations	238
HPLC columns for biochemical separations	244
HPLC columns for sugar analyses.....	253
Columns for gel permeation chromatography.....	257
MN column systems	258
Accessories	262
Packings for preparative applications:	
NUCLEODUR® high purity silica for HPLC.....	264
POLYGOSIL® irregular silica for HPLC	265

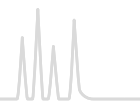

POLYGOPREP irregular silica for HPLC	266
Adsorbents for column chromatography	268



Thin layer chromatography

Basics	275
Introductory kits	277
Summary of MN ready-to-use layers	280
Unmodified TLC silica layers	282
Silica layers with concentrating zone	286
Unmodified HPTLC silica layers	288
Modified silica layers	291
Further layers	296
Layers for special TLC separations	299
Chromatography papers	302
Accessories	303
Reagents	304
Adsorbents	305



Gas chromatography

Basics	308
USP listing	310
Additional information for GC columns	311
Separation properties of OPTIMA [®] phases	313
Summary of MN phases for GC	314
OPTIMA [®] · nonpolar capillary columns	318
OPTIMA [®] · weakly polar capillary columns	322
OPTIMA [®] δ · phases with autoselectivity	327
OPTIMA [®] · medium polar capillary columns	329
OPTIMA [®] · polar capillary columns	341
PERMABOND [®] capillary columns	342
Special GC columns overview	344
Capillary columns for Fast GC	345
Capillary columns for enantiomer separation	347
Capillary columns for biodiesel analysis	351
Capillary columns for triglyceride analysis	353
Capillary columns for high temperature GC	354
Capillary columns for amine separation	355

Capillary columns for hydrocarbons	357
Capillary columns for silane · DEG.....	359
Fused silica capillaries.....	360
Reagents / methods for derivatization.....	362
Reagents / methods for acylation.....	364
Reagents / methods for alkylation / methylation.....	366
Reagents / methods for silylation	370
Derivatization procedures.....	372
Test mixtures for GC capillary columns.....	373
Ferrules for capillary columns	375
Septa for capillary column.....	376
Accessories for capillary columns	377
General accessories.....	378

Appendices

Index of reference numbers.....	379
List of abbreviations	396
Trademarks	398
List of literature	401

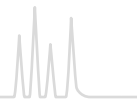

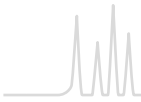

Contents

Basics..... 10

CHROMABOND® hardware 14

CHROMABOND® summary of MN phases 16

CHROMABOND® modern polymeric phases..... 18

CHROMABOND® polymer phases · others..... 29

CHROMABOND® reversed phases 33

CHROMABOND® normal phases 38

CHROMABOND® ion exchangers based on silica 45

Special phases · pharmac. applications 47

Special phases · environmental analysis..... 54

Special phases · food analysis 60

Special phases · others..... 62

SPE vacuum manifolds and accessories 66

Empty columns and accessories..... 68

High throughput SPE 69

Flash chromatography..... 72

CHROMABOND® Flash RS solutions for Isco® Flash instruments 78

CHROMABOND® Flash BT solutions for Biotage® Flash instruments..... 80

CHROMABOND® Flash connecting kits 82

Flash glass columns and accessories..... 83

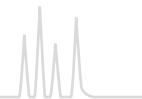

Solid phase extraction (SPE) is a powerful method for sample preparation and is used by most chromatographers today.

About 30 years ago MACHEREY-NAGEL designed and introduced CHROMABOND® SPE cartridges containing silica-based adsorbents. Since then we have developed the widest range of phases and products for SPE based on silica and polymeric materials.

SPE has capabilities in a broad range of applications

- Environmental analysis
- Pharmaceutical and biochemical analysis
- Organic chemistry
- Food analysis

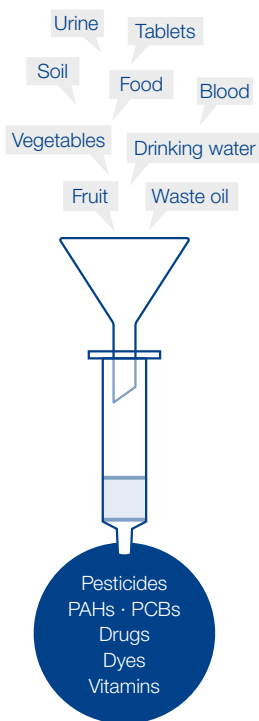

SPE is a form of digital (step-wise) chromatography designed to extract, partition, and/or adsorb one or more components from a liquid phase (sample) onto a stationary phase (adsorbent or resin). An adsorbed substance can be removed from the adsorbent by stepwise increase of elution strength of the eluent (step gradient technique). SPE extends a chromatographic system's lifetime, improves qualitative and quantitative analysis, and the demand placed on an analytical instrument is considerably lessened.

In general, SPE is used for three important purposes in state-of-the-art analysis

- Concentration of the analyte – up to factor 10.000 – increase of chromatographic sensibility and improved limits of detection
- Removal of interfering compounds – protection of subsequent analysis like HPLC, GC, TLC, UV or IR spectroscopy, ...
- Changing an analyte's environment to a simpler matrix more suitable for subsequent analysis

Advantages of SPE compared to classical liquid-liquid extraction

- Lower consumption of solvents
- Faster – enormous time savings
- Lower costs per sample
- Potential for automation
- High consistency in individual sample handling
- More specific selectivity because of the broad range of adsorbents and different retention mechanisms
- Optimization of extraction by the variation or adjusting of the solid phase and chromatographic conditions

Separation of food additives

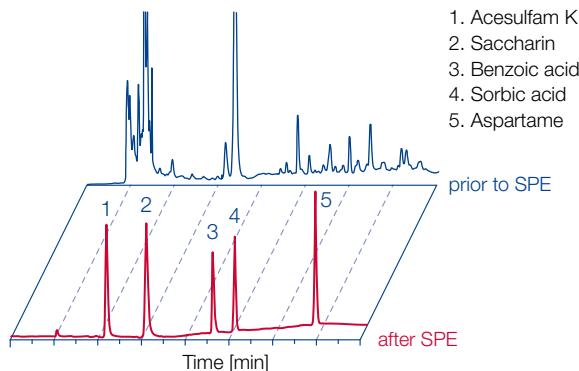

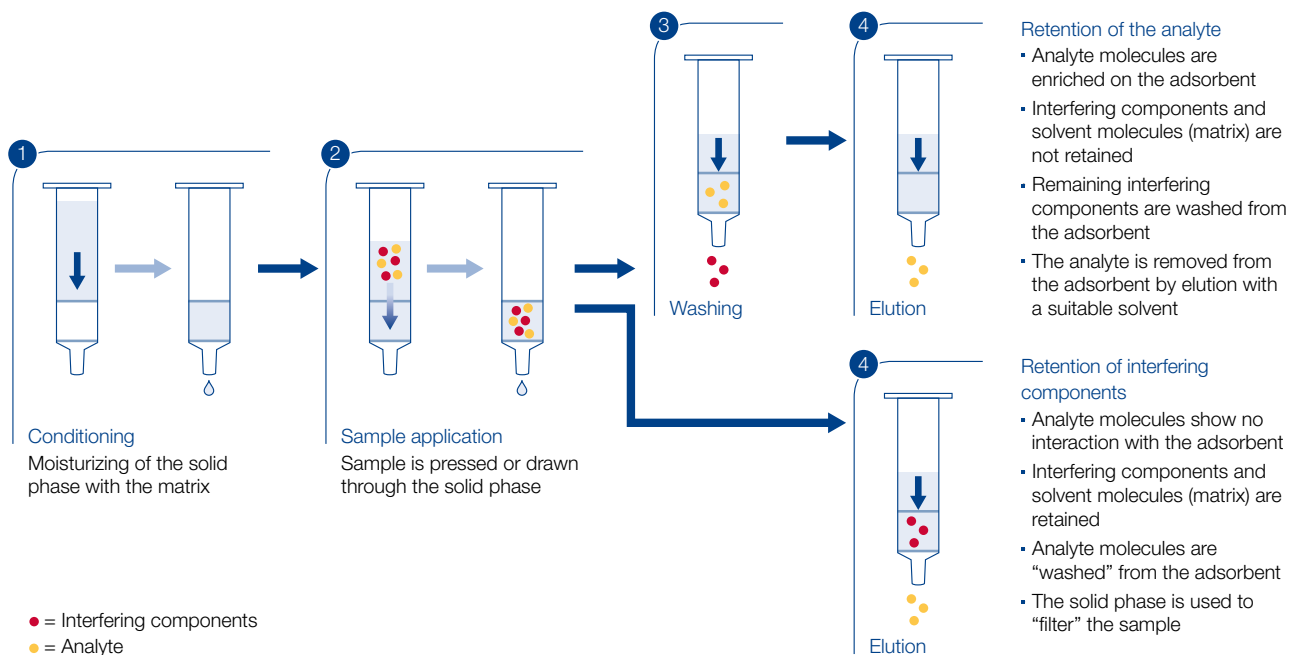

Since analytes can either be adsorbed on the SPE packing material or directly flow through while the interfering substances are retained, two general separation procedures are possible – both cases are shown in the figure above.

Main steps of the SPE procedure

① Conditioning of the adsorbent

Conditioning of the adsorbent is necessary in order to ensure reproducible interaction with the analyte. Conditioning, also called solvation, results in a wetting of the adsorbent and thus produces an environment, which is suitable for adsorption of the analyte. Nonpolar adsorbents are usually conditioned with 2–3 column volumes of a solvent, which is miscible with water (methanol, THF, 2-propanol etc.), followed by the solvent in which the analyte is dissolved (pure matrix, e.g., water, buffer). Polar adsorbents are conditioned with nonpolar solvents.

After the conditioning step the adsorbent bed must not run dry, because otherwise solvation is destroyed (deconditioning).

② Sample application (adsorption)

Sample application can be performed with positive or negative pressure with a flow rate of ~3 mL/min. Sample volumes vary from a few mL up to liters.

③ Washing of the adsorbent

Washing of the adsorbent is usually achieved with a special wash solution; however, in some cases it may not be necessary. If the polarity difference between wash solution and eluent is very large, or if both are not miscible, drying of the adsorbent bed after washing is recommended to improve elution and recovery.

④ Elution

Elution with a suitable eluent should not be too fast. The elution speed depends on the column or cartridge dimension and the quantity of adsorbent (about 1 mL/min).

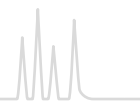

Molecular interactions in SPE

SPE adsorbents are most commonly categorized by the nature of their primary interaction mechanism with the analyte of interest. The three most common extraction mechanisms used in SPE are reversed phase (RP), normal phase (NP) and ion exchange.

Typical extraction mechanisms

- Reversed phase extraction of hydrophobic or polar organic analytes from aqueous matrix
- Normal phase extraction of polar analytes from nonpolar organic solvents
- Ion exchange extraction of charged analytes from aqueous or nonpolar organic samples

Types of retention mechanisms

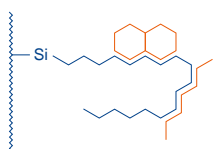

Nonpolar interactions

Silica-based: C₁₈ ec, C₁₈, C₁₈ Hydra, C₈
 Polymer-based: HR-X, HLB, HR-P, Easy
 Interactions: hydrophobic
 Sample: mostly aqueous
 Elution: solvents with lower polarity (compared to water)
 CH₃OH, CH₂Cl₂, CHCl₃, hexane

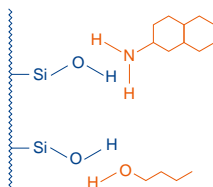

Polar interactions

Silica-based: SiOH, CN, NH₂, OH (diol)
 Other: Alox, Florisil®
 Interactions: hydrogen bonds, dipole-dipole and π-π interactions
 Sample: mostly organic
 Elution: polar solvents (compared to sample solvent), e.g., (nonprotic) ethers, ketones (MTBE, THF, acetone), CH₂Cl₂, CHCl₃

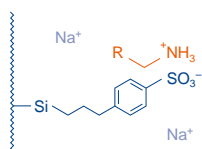

Cation exchangers

Silica-based: SA (SCX), PCA (WCX), PSA
 Polymer-based: HR-XC, HR-XCW, PS-H⁺
 Interaction: between charged analytes and functional group of cation exchanger
 Sample: aqueous (pH 3–5)
 Elution: acidic: pH 2 (e.g., HCl, or 20 % AcOH in CH₃OH – CH₃CN)
 basic: pH 8–9 (e.g., 5 % NH₃ in CH₃OH – CH₃CN) solvents or buffers with higher ionic strength and counter ions with high selectivity (e.g., Ca²⁺)

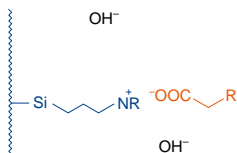

Anion exchangers

Silica-based: SB (SAX), NH₂
 Polymer-based: HR-XA, HR-XAW, PS-OH⁻, WAX
 Interaction: between charged analytes and functional group of anion exchanger
 Sample: aqueous (pH 8–9)
 Elution: basic: pH 10 (e.g., 20 % NH₃ in CH₃OH – CH₃CN)
 acidic: pH 4–5 (e.g., HCl, or 5 % AcOH in CH₃OH – CH₃CN) solvents or buffers with higher ionic strength and counter ions with high selectivity (e.g., citrate)

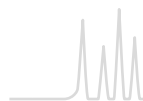

It should be noted, that in SPE the interactions described on page 12 are not found in pure form, but in combination. For example, modified silicas, unless they have been subjected to

endcapping (silanization of residual silanol groups with short-chain silanes), still possess free silanol groups, which can enter into secondary interactions.

Sample pretreatment

For direct extraction with adsorbents the sample matrix (sample environment) has to fulfill three conditions:

- The matrix has to be liquid, if possible with low viscosity
- Solids should be removed from the liquid matrix
- The matrix (sample environment) should be suitable for retention of the analyte

For solid samples there are different methods to convert the sample into a suitable matrix:

- Dissolution of the solid sample in a suitable solvent
- Lyophilization of the sample and dissolution in a suitable solvent
- Extraction of the solid sample with a suitable solvent
- Homogenization of the sample in a suitable solvent

In order to find the suitable solvent, one has to consider all desired sample components. Also, the suitable solvent should enhance retention of the analyte. For example, samples with large contents of solids are often homogenized in nonpolar solvents like hexane, while for samples with high water content dissolution in acids, bases, buffers or very polar solvents such as methanol is recommended.

Additionally, SPE allows to alter the properties of the sample matrix. If, for example, natural products are extracted with methanol or acetone, the polarity of the extracts can be increased by dilution with water, in order to enhance nonpolar solid phase extraction on the C₁₈ material.

Our CHROMABOND® QC policy

- Highest production standard – our facilities are ISO 9001:2015 certified
- All products are individually tested to meet our strict quality specifications, ensuring our outstanding product reproducibility, reliability and performance
- Perfect reproducibility from lot-to-lot and within every single batch:
 - Careful attention to particle size distribution and pore diameters assures consistent column flow
 - Chemical reproducibility is guaranteed by strict quality control throughout manufacturing
- Each product is supplied with a certificate of analysis stating the results of internal examinations and quality control

Certificate of analysis		
Phase:	CHROMABOND®HR-X	
Sorbent-LOT:	0223/24	
Technical Data		
Material:	porous adsorbent resin based on polystyrene-divinylbenzene	
Description:	yellow powder	
Parameter	Specification	Result
Pore Diameter (Å):	50-70	65
Surface Area (m ² /g):	>650	1008
Particle Size - 90 % Volume (µm):	65-85	81
Capacity (mg caffeine/g sorbent):	>250	420
The packing quantity varies ± 5 % referred to the amount given on the label or in the catalog.		
Confirmation		
Hereby we confirm that the above mentioned product has successfully passed our quality control system in accordance with ISO 9001 and meets the specific quality criteria.		
This document has been produced electronically and is valid without a signature.		
		1/2

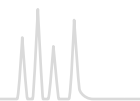

Design of columns, cartridges and 96-well plates

All CHROMABOND® columns, cartridges and 96-well plates are manufactured from polypropylene (PP) with lowest content of extractables (plasticizers, stabilizers, ...) offering blank value free results when using most common solvents.

The high quality CHROMABOND® adsorbents are kept in place by chemically very inert polyethylene filter elements.

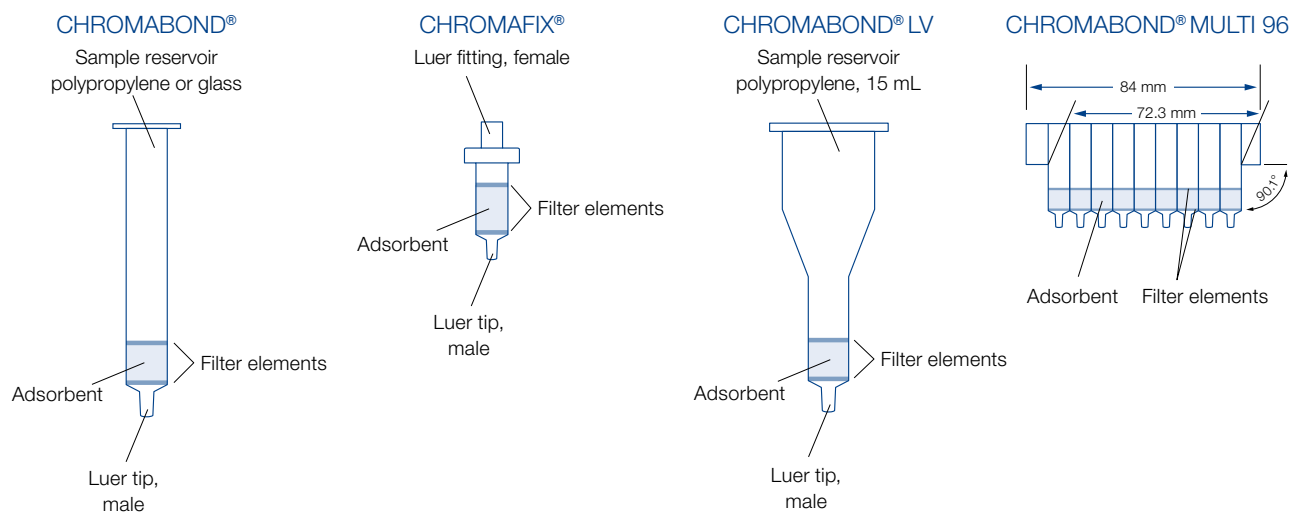

CHROMABOND® polypropylene columns

- PP columns with PE filter elements
- Different sizes from 1, 3, 6 up to 150 mL
- Adsorbent weights from 20 mg to 50 g
- Male Luer tip as exit
- Compatible with most robots (e.g., Gilson® ASPEC™, Caliper AutoTrace®)

CHROMABOND® glass columns

- Glass columns with chemically very inert glass fiber filter elements (nominal pore size 1 µm)
- Two different sizes: 3 and 6 mL
- Available with all CHROMABOND® phases
- Excludes any influence from the column material (e.g., plasticizers)

CHROMAFIX® cartridges

- PP cartridges with PE filter elements
- Three different sizes with different adsorbent weights: Small (0.4 mL), Medium (0.8 mL), Large (1.8 mL)
- Female Luer fitting at the inlet, male Luer tip as exit
- Offers alternative way of handling using positive pressure by syringes or peristaltic pumps
- Especially suited for convenient solid phase extraction of small sample volumes

CHROMABOND® LV columns

- Large volume PP columns with PE filter elements
- Three different adsorbent weights (100, 200 and 500 mg)
- Funnel-shaped reservoir with 15 mL volume
- Especially for clinical samples – the whole sample (e.g., urine, serum, blood) can be applied to the column in one step
- Can be directly used in the Zymate® lab robots of Zymark®

CHROMABOND® MULTI 96 · SPE in 96-well format

- 96-well PP plates with PE filter elements
- Cavity volume 1.5 mL
- Adsorbent weights 10, 25, 50 and 100 mg
- Supplied with any CHROMABOND® SPE adsorbents
- For the simultaneous preparation of 96 samples
- Easy method transfer from CHROMABOND® columns or CHROMAFIX® cartridges to CHROMABOND® MULTI 96
- Readily adaptable to all common automated / robotic handling systems (for details see page 69)

On-line SPE (see page 69)

- Online columns and cartridges
- SPE columns with caps and needles for the Gerstel MultiPurposeSampler (MPS)
- Columns for Gilson® ASPEC™ systems (ASP)



CHROMABOND® SPE columns from page 21 onwards

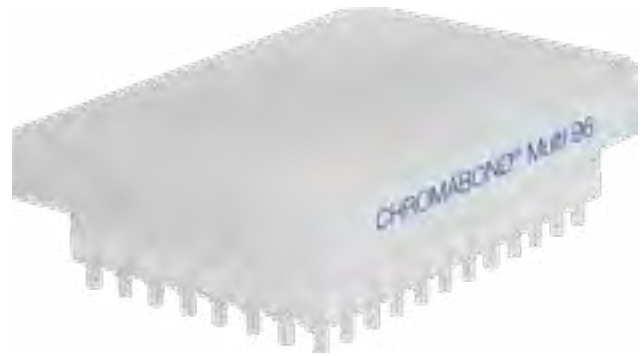

CHROMABOND® Multi 96 page 14 and 70



CHROMABOND® Flash RS page 78



CHROMABOND® Flash BT page 80

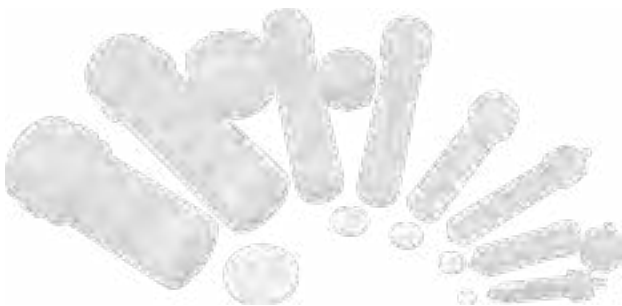

CHROMABOND® Flash DL page 80



CHROMABOND[®] summary of MN phases

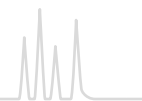

CHROMABOND [®] Phase	Matrix	Modification / Application	Similar phases*	Page
Reversed phases				
HLB	NVP/DVB	Hydrophilic-lipophilic balance	Strata [™] -X · Oasis [®] HLB · Isolute [®] ENV ⁺ · Supel [™] -Select HLB · Supra-Poly [®] HLB · STYRE SCREEN [®] HLB · Oasis [®] PRIME HLB	22
HR-X	PS/DVB		Supelclean [™] ENVI-Chrom P · Bond Elut [®] Nexus · Strata [™] -X · Bakerbond [™] H ₂ O-phobic DVB · STYRE SCREEN [®] HLD · Styre Screen [®] DVB	25
Easy	PS/DVB	polar, bifunctional	Porapak [™] RDX · Bond Elut [®] Nexus, PPL, Focus [™] · Bakerbond [™] H ₂ O-philic DVB · TELOS [®] PS-DVB ENV	30
HR-P	PS/DVB		Strata [™] SDB-L · Bond Elut [®] ENV, LMS · Discovery [®] DSC-PS/DVB · TELOS [®] PS-DVB · Bakerbond [™] H ₂ O-phobic DVB · Isolute [®] 101 · LiChrolut [®] EN	31
PS-RP	PS/DVB	removal of organic components	like HR-P	32
C ₁₈ ec	silica	octadecyl, endcapped	Strata [™] C ₁₈ -E · Sep-Pak [®] tC ₁₈ · Bond Elut [®] C ₁₈ · Discovery [®] DSC-18(Lt) · Supelclean [™] ENVI-18, LC-18 · CLEAN-UP [®] C ₁₈ · Bakerbond [®] Octadecyl · Isolute [®] C ₁₈ (EC) · LiChrolut [®] RP-18 E	33
C ₁₈ ec f	silica	as above, fast flow		33
C ₁₈	silica	octadecyl, not endcapped	Strata [™] C ₁₈ -U · AccuBond [®] C ₁₈ · Bakerbond [™] PolarPlus · Isolute [®] C ₁₈ · LiChrolut [®] RP-18 · Bond Elut [®] C ₁₈ OH	34
C ₁₈ f	silica	as above, fast flow		34
C ₁₈ Hydra	silica	octadecyl, not endcapped, more polar		35
C ₈	silica	octyl	Strata [™] C ₈ · Sep-Pak [®] C ₈ · Bond Elut [®] C ₈ · Discovery [®] DSC-8 · Supelclean [™] LC-8, ENVI-8 · CLEAN-UP [®] C ₈ · AccuBond [®] C ₈ · Bakerbond [™] Octyl · Isolute [®] C ₈ (EC)	36
C ₄	silica	butyl	ISOLUTE [®] C ₄	36
C ₂	silica	dimethyl	Bond Elut [®] C ₂ · ISOLUTE [®] C ₂ (EC) · Bakerbond [™] Ethyl (C ₂)	37
C ₆ H ₅	silica	phenyl	Strata [™] PH · Bond Elut [®] PH · Discovery [®] DSC-Ph · CLEAN-UP [®] Phenyl · AccuBond [®] Phenyl · Bakerbond [™] Phenyl · Isolute PH(EC)	37
Normal phases				
SiOH	silica	unmodified	Strata [™] Si-1 · Bond Elut [®] silica · Discovery [®] DSC-Si · Supelclean [™] LC-Si · CLEAN-UP [®] silica · AccuBond [®] silica · Bakerbond [™] silica gel · Isolute [®] silica · LiChrolut [®] Si	38
NH ₂	silica	aminopropyl	Strata [™] NH ₂ · Sep-Pak [®] NH ₂ · Bond Elut [®] NH ₂ · Discovery [®] DSC-NH ₂ · CLEAN-UP [®] aminopropyl · AccuBond [®] NH ₂ · Bakerbond [™] Amino · Isolute [®] NH ₂ · LiChrolut [®] NH ₂	39
OH (Diol)	silica	diol	Discovery [®] DSC-Diol, LC-Diol · AccuBond [®] Diol (OH) · ISOLUTE [®] DIOL · Sep-Pak [®] Diol · Bond Elut [®] Diol (2OH)	40
CN	silica	cyano	Strata [™] CN · Sep-Pak [®] CN · Bond Elut [®] CN-U · Discovery [®] DSC-CN · Supelclean [™] LC-CN · CLEAN-UP [®] CN · AccuBond [®] CN · Bakerbond [™] cyano · Isolute [®] CN · LiChrolut [®] CN	40
HILIC	silica	zwitterionic ammonium-sulfonic acid modification	ZIC [®] HILIC	41
Alox A	aluminum oxide	acidic	LC-Alumina-A · AccuBond [®] Aluminiumoxid A · Bond Elut [®] Alumina A	42
Alox N	aluminum oxide	neutral	LC-Alumina-N · AccuBond [®] Aluminiumoxid N · Bakerbond [™] Alumina Neutral · Bond Elut [®] Alumina N	42
Alox B	aluminum oxide	basic	LC-Alumina-B · AccuBond [®] Aluminiumoxid B · Bond Elut [®] Alumina B	42
Florisil [®]	magnesium silicate		Strata [™] FL-PR · Sep-Pak [®] Florisil [®] · Bond Elut [®] Florisil [®] · Supelclean [™] LC-Florisil [®] , ENVI-Florisil [®] · CLEAN-UP [®] Florisil [®] · AccuBond [®] Florisil [®] · Bakerbond [™] Florisil [®] · Isolute [®] FL · LiChrolut [®] Florisil [®]	43
PA	polyamide 6		Discovery [®] DPA-6S	43
Ion exchangers				
SA	silica	benzenesulfonic acid cation exchanger (SCX)	Strata [™] SCX · Bond Elut [®] SCX · Discovery [®] DSC-SCX · Supelclean [™] LC-SCX · CLEAN-UP [®] Benzenesulfonic Acid · AccuBond [®] SCX · Bakerbond [™] Aromatic Sulfonic Acid · Isolute [®] SCX · LiChrolut [®] SCX	44
SB	silica	quaternary ammonium anion exchanger (SAX)	Strata [™] SAX · Sep-Pak [®] SAX · Bond Elut [®] SAX · Discovery [®] DSC-SAX · Supelclean [™] LC-SAX · CLEAN-UP [®] Quaternary Amine · AccuBond [®] SAX · Bakerbond [™] Quaternary Amine · Isolute [®] SAX · LiChrolut [®] SAX	45
PCA	silica	propylcarboxylic acid cation exchanger (WCX)	Strata [™] WCX · Bond Elut [®] CBA · Discovery [®] DSC-WCX · Supelclean [™] LC-WCX · CLEAN-UP [®] Carboxylic Acid · Bakerbond [™] Carboxylic Acid · Isolute [®] CBA · Styre Screen [®] CCX	46



CHROMABOND® summary of MN phases



CHROMABOND® Phase	Matrix	Modification / Application	Similar phases*	Page
PSA**	silica	propylsulfonic acid cation exchanger	Isolute® SCX-2 · Bond Elut® PRS	46
HR-XC	PS/DVB	strong mixed-mode cation exchanger (MCX)	Oasis® MCX · Strata™-X-C · HyperSep™ Retain-CX · Styre Screen® BCX · EVOLUTE® EXPRESS CX	25
HR-XA	PS/DVB	strong mixed-mode anion exchanger (MAX)	Oasis® MAX · Strata™-X-A · HyperSep™ Retain-AX · Styre Screen® QAX · EVOLUTE® EXPRESS AX	26
HR-XCW	PS/DVB	weak mixed-mode cation exchanger (WCX)	Oasis® WCX · Strata™-X-CW · EVOLUTE® EXPRESS WCX	27
HR-XAW	PS/DVB	weak mixed-mode anion exchanger (WAX)	Oasis® WAX · Strata™-X-AW · EVOLUTE® EXPRESS WAX	28
WAX	PS/DVB	weak mixed-mode cation exchanger (WAX)	Oasis® WAX for PFAS analysis · Strata™ X-AW · Bond Elut® PFAS WAX	29
PS-OH ⁻	PS/DVB	strong anion exchanger in OH ⁻ form		32
PS-H ⁺	PS/DVB	strong cation exchanger in H ⁺ form		32
PS-Mix	PS/DVB	mixture of PS-OH ⁻ and PS-H ⁺		32
PS-Ag ⁺	PS/DVB	strong cation exchanger in Ag ⁺ form		32
PS-Ba ²⁺	PS/DVB	strong cation exchanger in Ba ²⁺ form		32
Phases for special applications				
Drug	silica	bifunctional C ₈ /SA, for enrichment of drugs from urine	Strata™ Screen-C · Bond Elut® Certify I · Discovery® DSC-MCAX · Clean Screen® DAU · AccuBond® Evidex · Bakerbond™ Narc-2 · Isolute® HCX · LiChrolut® TSC · HyperSep™ Verify CX	47
Drug II	silica	bifunctional C ₈ /SB, for extraction of THC and derivatives and of acidic analytes from biological fluids	Strata™ Screen-A · Bond Elut® Certify II · Clean Screen® THC · Bakerbond™ Narc-1 · Isolute® HAX · HyperSep™ Verify AX	48
HR-P-AOX	PS/DVB	for extraction of AOX from water (DIN 38409 – H22)		50
C ₁₈ PAH	silica	special octadecyl phase, for enrichment of PAHs from water	Bakerbond™ Octadecyl Lightload · ISOLUTE® PAH	50
NH ₂ /C ₁₈	silica	combination phase for enrichment of PAHs from water	Bakerbond™ PAH AQUA	51
CN/SiOH	silica	combination phase for enrichment of PAHs from soil	Bakerbond™ PAH SOIL	51
Na ₂ SO ₄ /Florisol®	Na ₂ SO ₄ + magnesium silicate	combination phase for extraction of hydrocarbons from water (DIN H-53 / ISO DIS 9377 – 4)	ISOLUTE® Na ₂ SO ₄ /FL	52
NAN	silica / AgNO ₃ + Na ₂ SO ₄	combination phase for enrichment of PCBs from sludge		53
SA/SiOH	silica	combination phase for enrichment of PCBs from waste oil	Bakerbond™ PCB-N	54
SiOH-H ₂ SO ₄ /SA	silica	combination phase, used together with SiOH for enrichment of PCB from oil	Bakerbond™ PCB-A	55
QuEChERS / Diamino	silica	primary and secondary amine functions (PSA), for determination of pesticides in food samples (QuEChERS method)	Supelclean™ PSA · Bond Elut® PSA · ISOLUTE® PSA · CLEAN UP® Primary/Secondary Amine · Bakerbond™ Diamino	56
ABC18	silica	octadecyl, with ion exchange functions, for acrylamide analysis	Isolute® M-M (multimode)	61
Carbon A	activated carbon	determination of acrylamide from water according to DIN 38413-6	Bakerbond™ Carbon · BEKOLut® Carbon SAC · Sep-Pak® AC ₂	61
Dry	Na ₂ SO ₄	for drying organic samples	ISOLUTE® Sodium Sulfate · Sep-Pak® Dry · Bond Elut® Sodium Sulfate	62
PTL/PTS	special membrane	phase separation		63
PFAS	polymer	special polymeric combination phase for the enrichment of PFAS from water, soil and textiles		49
XTR	kieselguhr	liquid-liquid extraction	EXTrelut® · Chem Elut™ · Hydromatrix™ · Isolute® SLE +	64

* Phases which provide a similar selectivity based on chemical or physical properties (list not complete)

** For primary and secondary amine functions see QuEChERS / Diamino

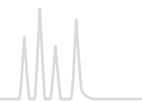

Modern polymer SPE phases

The family comprises 6 polymer-based RP and mixed-mode ion exchange phases:

- CHROMABOND® HLB hydrophilic-lipophilic balance NVP/DVB copolymer
- CHROMABOND® HR-X hydrophobic PS/DVB copolymer
- CHROMABOND® HR-XC strong mixed-mode cation exchanger
- CHROMABOND® HR-XA strong mixed-mode anion exchanger
- CHROMABOND® HR-XCW weak mixed-mode cation exchanger
- CHROMABOND® HR-XAW weak mixed-mode anion exchanger

Characteristics

State-of-the-art spherical polymers

- Two particle sizes (45 µm and 85 µm for the HR-X series; 30 µm and 60 µm for HLB) adequate for different sample volumes and matrices
- Broad spectrum of application with special suitability for the enrichment of pharmaceuticals from biological matrices
- Ideal flow properties due to low content of particulate matter

Optimized pore structure and high specific surface

- High loadability and outstanding elution properties
- Low solvent consumption
- Rapid, economical analysis

High-purity adsorbent material

- Allows highest reproducibility with extremely low blind values
- Reliable analysis at ultra trace level
- No method adaptation for new batches necessary

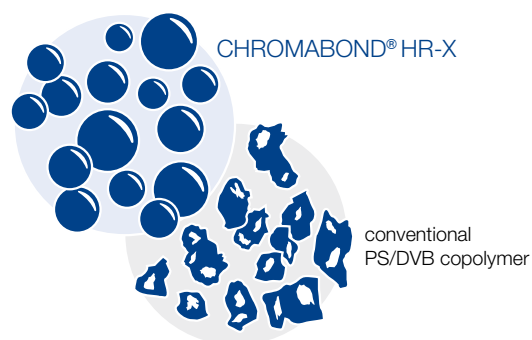

Adsorbent blind values:

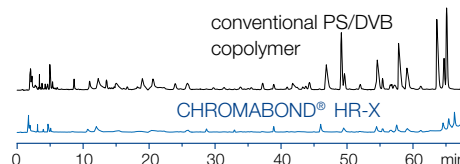

Advantages

RP and mixed-mode SPE phases with distinct ion exchange and reversed phase properties:

- Excellent enrichment of neutral, acidic and basic compounds

Modern, spherical support polymer with optimized pore structure and high surface:

- Good reproducibility, reliable and cost-efficient analysis

Possibility for more aggressive washing procedures for matrix removal:

- Cleaner samples and protection of your HPLC and GC instruments

Quantification of analytes also from heavily contaminated samples:

- Lower limits of detection also for critical matrices

The portfolio of modern polymer phases offers solutions to all tasks in sample preparation.



Chemical structures of the phases

CHROMABOND® HLB

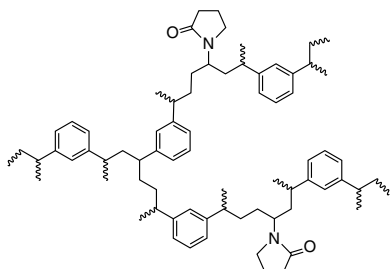

hydrophilic-lipophilic balance *N*-vinylpyrrolidone-divinylbenzene copolymer

CHROMABOND® HR-X

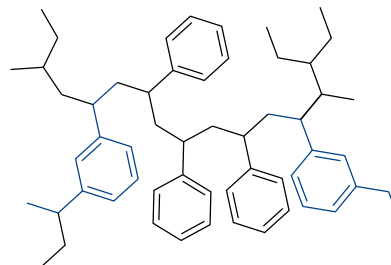

hydrophobic polystyrene-divinylbenzene copolymer
spherical base material for efficient enrichment and ideal flow behavior

CHROMABOND® HR-XCW

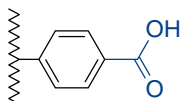

weak acidic cation exchanger

CHROMABOND® HR-XA

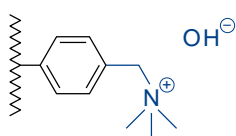

strong basic anion exchanger

CHROMABOND® HR-XAW

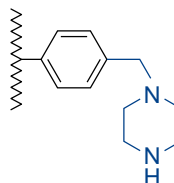

weak basic anion exchanger

CHROMABOND® HR-XC

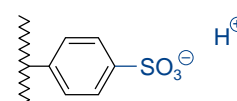

strong acidic cation exchanger

Similar phases

- CHROMABOND® HLB Oasis® HLB · Isolute® ENV⁺ · SupelTM-Select HLB · Supra-Poly® HLB · STYRE SCREEN® HLB · Oasis® PRIME HLB · StrataTM-X
- CHROMABOND® HR-X SupelcleanTM ENVI-Chrom P · Bond Elut® Nexus · StrataTM-X · Bakerbond H₂O-phobic DVB · STYRE SCREEN® HLD · Styre Screen® DVB
- CHROMABOND® HR-XC Oasis® MCX, StrataTM-X-C, HyperSepTM Retain-CX, StyreScreen® BCX, EVOLUTE® EXPRESS CX
- CHROMABOND® HR-XA Oasis® MAX, StrataTM-X-A, HyperSepTM Retain-AX, StyreScreen® QAX, EVOLUTE® EXPRESS AX
- CHROMABOND® HR-XCW Oasis® WCX, StrataTM-X-CW
- CHROMABOND® HR-XAW Oasis® WAX, StrataTM-X-AW

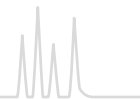

2 particle sizes – 1 goal: provide an ideal solution for optimized sample preparation

For different application requirements the particle sizes complement each other perfectly. In the following passage this is demonstrated on the basis of 45 µm and 85 µm CHROMABOND® HR-X particles

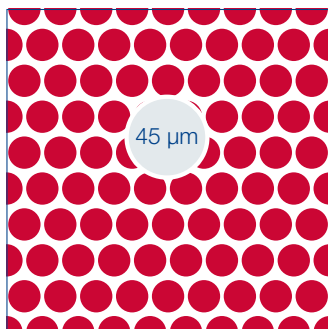

Ideal for:

- Smaller sample volumes
- Smaller adsorbent weights
- Lower elution volumes

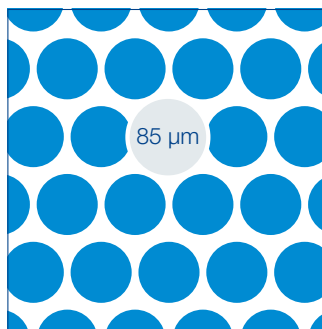

Recommended for:

- Large volume or viscous samples, heavy matrix load
- Operation without vacuum possible (e.g., for volatile analytes)
- Higher adsorbent weight without increase in back pressure

Features of 45 µm particles

- About half the radius results in 8-fold particle number per volume for approx. equal adsorbent weight
- Same specific surface for both particle sizes: considerably larger freely accessible external surface for 45 µm particles
- Denser adsorbent packing: enhanced interaction of the analyte with the adsorbent, better extraction results

Ideal elution characteristics

Method: 1 mL column with 30 mg CHROMABOND® HR-X, 1 mL standard solution (1 mg/mL hexobarbital), drying, elution in portions of 100 µL with methanol (see application 305490 at <https://chromaappdb.mn-net.com/>)

Recovery rates 45 µm

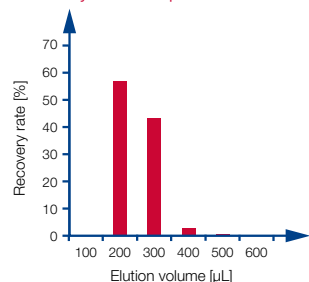

Advantages of 45 µm particles:

- Faster elution
- Lower elution volumes required

Recovery rates 85 µm

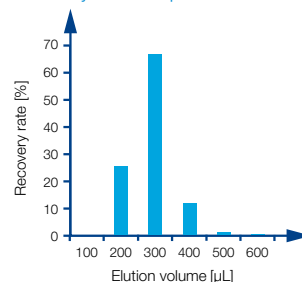

Breakthrough behavior in enrichment

Method: 1 mL column with 15 mg CHROMABOND® HR-X, apply portions of 1 mL standard solution (250 µg/mL hexobarbital in water), collect eluates (see application 305480 at www.mn-net.com)

45 µm (red) The analyte is completely retained up to fraction 10.

85 µm (blue) Small amounts even break through with fraction 4.

45 µm particles provide better enrichment and breakthrough behavior for small adsorbent weights. When using larger adsorbent weights this effect is less pronounced, since then analytes have sufficient contact with the 85 µm adsorbent particles as well.

45 µm particles are ideal for small sample and elution volumes, while for large amounts of sample and adsorbent 85 µm particles show advantages due to better flow properties.

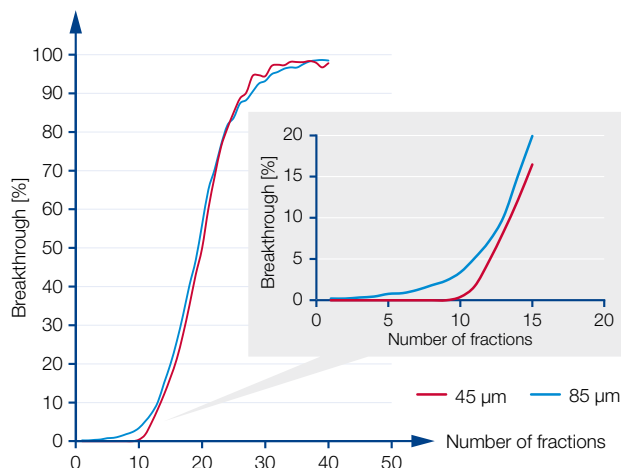

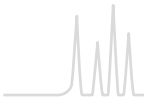

CHROMABOND® SPE – Modern polymer phases selection guide

Stationary phase selection

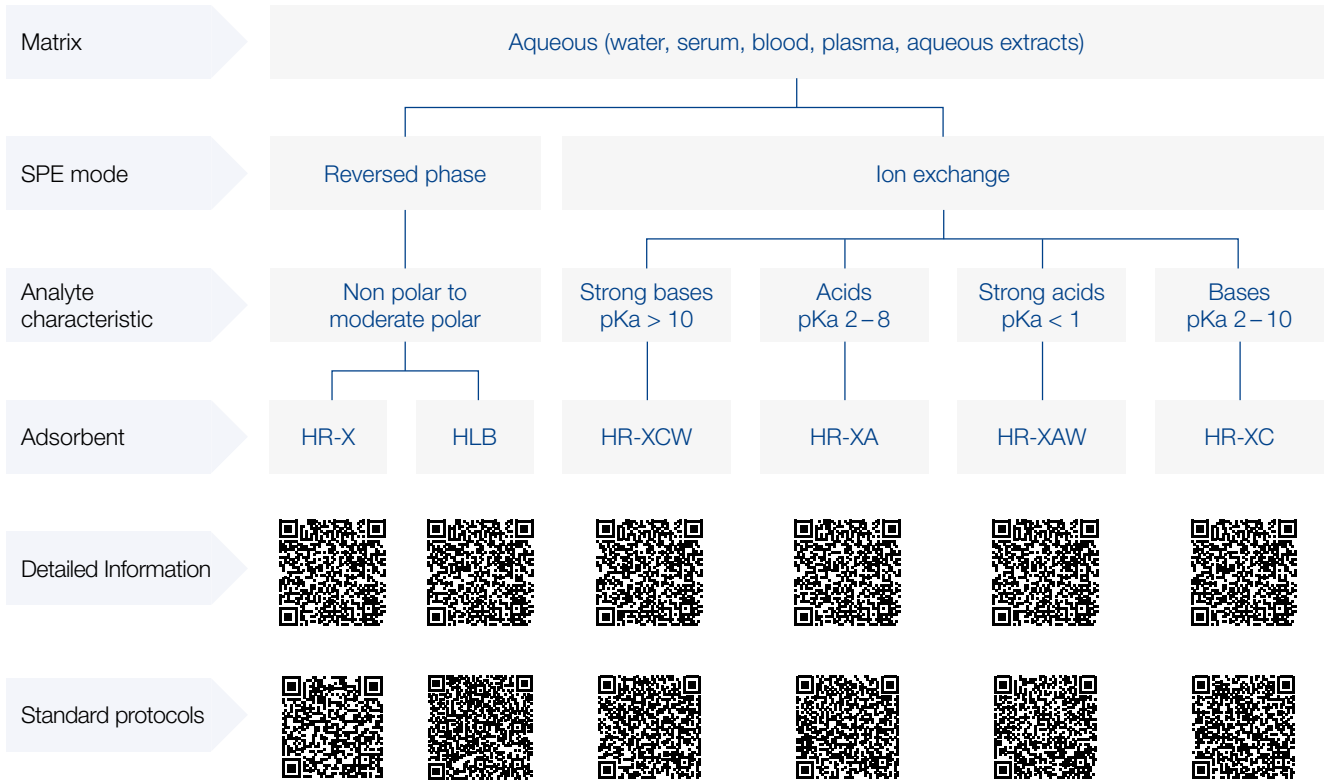



CHROMABOND® modern polymeric phases

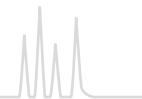

CHROMABOND® HLB hydrophilic-lipophilic balance

★ Key features

- High purity material with highest reproducibility and lowest blank values due to an optimized production process
- Applicable for a wide range of analyte polarities
- High loadability and outstanding performance
- Water wettable – even if bed runs dry, SPE can be continued

🔧 Technical characteristics

- Reversed phase (hydrophilic-lipophilic), base material
N-vinylpyrrolidone-divinylbenzene copolymer (NVP/DVB), pH stability 1 – 14
- Spherical particles, size 60 µm and 30 µm, pore size 65 Å, large specific surface area of 750 m²/g

✓ Recommended application

- Medium polar organic molecules from polar matrices
- Drugs and pharmaceuticals from urine, blood, serum and plasma
- Tetracyclines and alkaloids from serum
- Pesticides from water

Mycotoxins in wheat flour

MN Appl. No. 306740

Chromatographic conditions

Column type:

CHROMABOND® HLB / 60 µm / 3 mL / 200 mg

REF: 730924

Extraction:

- Weigh 4 g homogenized sample in an empty 50 mL centrifuge tube
- Add 8 µL mycotoxin standard mixture (β = 10 µg/mL each analyte in acetonitrile)
- Add 10 mL of water / acetonitrile mixture (20:80, v/v), shake vigorously and wait 10 min
- Add CHROMABOND® QuEChERS extraction Mix XII (REF 730648), shake vigorously for 1 min and cool the mixture down in an ice bath
- Centrifuge at 4500 rpm for 20 min at 20 °C
- Take organic phase for clean-up procedure

Conditioning: 6 mL acetonitrile

Application: 1 mL sample extract was aspirated with low vacuum into a vial

Elution: 4 mL acetonitrile were aspirated with low vacuum into a vial

Evaporation: Combine cleaned sample extract and acetonitrile eluate and evaporate to dryness under nitrogen, 60 °C

Reconstitution: In 1 mL acetonitrile

Analyte	Recovery rate [%]	RSD [%], n = 5
Aflatoxin B1	88	2.6
Aflatoxin B2	91	5.0
Aflatoxin G1	85	2.6
Aflatoxin G2	88	4.5
HT-2 toxin	115	5.7
T-2 toxin	106	5.1
Zearalenone	49	3.4

Volume	Adsorbent weight							Pack of
	30 mg	60 mg	100 mg	150 mg	200 mg	500 mg	1 g	
CHROMABOND® HLB polypropylene columns (60 µm)								
1 mL	730921		730922					30
3 mL		730923			730924	730925		30
6 mL				730944	730926	730927		30
15 mL						730928	730929	20
CHROMABOND® HLB polypropylene columns (60 µm) · BIGpacks								
3 mL		730923.250			730924.250			250
6 mL					730926.250	730927.250		250
CHROMABOND® HLB polypropylene columns (30 µm)								
1 mL	730921P30		730922P30					30
3 mL		730923P30			730924P30			30
6 mL				730944P30				30
CHROMABOND® LV-HLB (30 µm)								
15 mL	732140	732141						30
Size								
	Minimum adsorbent weight	S	M	L				Pack of
		50 mg	120 mg	350 mg				
CHROMAFIX® HLB cartridges (60 µm)								
		731921	731922	731923				50
Adsorbent weight								
		96 × 10 mg	96 × 30 mg	96 × 60 mg				
CHROMABOND® MULTI 96 HLB (60 µm)								
					738920.060M			1
CHROMAFIX® MULTI 96 HLB (30 µm)								
		738921.010M	738921.030M					1



CHROMABOND® HR-X HR-X spherical, hydrophobic polystyrene-divinylbenzene adsorbent resin

★ Key features

- High-purity material with highest reproducibility and lowest blank values due to an optimized manufacturing process
- Excellent recovery rates especially for the enrichment of pharmaceuticals and active ingredients due to the spherical structure of the particles, very homogeneous surface and optimized pore structure

🔧 Technical characteristics

- Hydrophobic polystyrene-divinylbenzene copolymer, pH stability 1 – 14
- Spherical particles, size 45 µm and 85 µm (standard), pore size 55 – 60 Å, very high surface 1000 m²/g, capacity 390 mg/g (caffeine in water)

✓ Recommended application

- Pharmaceuticals / active ingredients from tablets, creams and water / waste water
- Drugs and pharmaceuticals from urine, blood, serum and plasma
- Trace analysis of pesticides, herbicides, phenols, PAHs and PCBs from water

Drugs from water

MN Appl. No. 304240

Column type:
CHROMABOND® HR-X, 3 mL, 200 mg
REF 730931

Sample: 1 µg/mL each in water

Column conditioning: 5 mL methanol, 5 mL dist. water

Sample application:

slowly aspirate 500 mL water (pH 3) through the column

Column washing: 5 mL water

Elution: after drying 3 x 2 mL acetonitrile

Further analysis: HPLC on NUCLEODUR® C₁₈ Gravity, 5 µm; see MN Appl. No. 121690

Recovery rates [%]

Compound	HR-X	Strata™ X
Ketoprofen	98	92
Ibuprofen	91	93
Pentobarbital	99	95
Meclofenamic acid	92	93
Protriptyline	63	45
Nortriptyline	53	39

Pesticides from water

MN Appl. No. 304250 / 304260

Column type:
CHROMABOND® HR-X, 3 mL, 200 mg
REF 730931

Sample pretreatment: samples are spiked with 500 ng of each pesticide in 1000 mL water, adjusted to pH 2 with HCl or pH 7

Column conditioning:

10 mL methanol, 10 mL dist. water

Sample application:

slowly pass 1000 mL spiked water sample through the column with the aid of a tubing adapter (REF 730243)

Elution: after drying 5 mL methanol – THF (1:1, v/v)

Further analysis: HPLC

Recovery rates [%]

Compound	HR-X pH 2	Compound	HR-X pH 7
Metamitron	86	Desisopropylatrazine	90
Quinmerac	90	2,4-Dichlorobenzamide	95
Chloridazon	93	Desethylatrazine	89
Picloram	83	Hexazinone	95
Metribuzin	84	Bromacil	103
Cyanazine	83	Simazine	91
Metabenzthiazuron	94	Desethylterbuthylazine	89
Chlortoluron	91	Atrazine	88
Isoproturon	89	Metaxyl	97
Diuron	91	Metazachlor	93
Dimethenamid-P	89	Propazine	88
Linuron	94	Terbuthylazine	86
Epoxyconazole	85	Metolachlor	97
Penconazole	90		
Alachlor	93		
Propiconazole-1	89		
Flufenacet	91		
Diflufenicam	58		
Triallate	42		

For further applications on CHROMABOND® phases visit our online application database at <https://chromaappdb.mn-net.com/>



CHROMABOND® modern polymeric phases

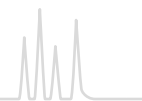

Standard protocol for CHROMABOND® HR-X

MN Appl. No. 304310



Column type:
CHROMABOND® HR-X, 3 mL, 200 mg
REF 730931

Sample pretreatment: if necessary, adjust pH value

Column conditioning: 5 mL methanol

Equilibration: 5 mL water

Sample application: slowly aspirate the sample through the column

Column washing: 5 mL water – methanol (95:5, v/v)

Elution: after drying 3 x 2 mL methanol

Further analysis: if necessary, evaporate and redissolve in a suitable solvent; HPLC or GC

Highest reproducibility Barbiturates from serum

MN Appl. No. 304290



Column type:
CHROMABOND® HR-X, 3 mL, 200 mg
REF 730931

Sample: 100 ng/mL each in serum

Column conditioning: 5 mL methanol, 5 mL dist. water

Sample application: 1 mL spiked serum

Column washing: 5 mL water

Elution: after drying 3 x 2 mL methanol

Further analysis: HPLC on NUCLEODUR® 100-5 C₁₈ ec, see MN Appl. No. 117820

- Within each batch
- From batch to batch

Compounds:

- A phenobarbital
- B pentobarbital
- C hexobarbital



Volume	Adsorbent weight →						Pack of
	30 mg	60 mg	100 mg	200 mg	500 mg	1 g	
CHROMABOND® HR-X polypropylene columns (85 µm)							
1 mL	730934		730935				30
3 mL		730936		730931	730937		30
6 mL				730938	730939		30
15 mL					730940	730941	20
CHROMABOND® HR-X polypropylene columns (85 µm) · BIGpacks							
3 mL				730931.250			250
6 mL				730938.250	730939.250		250
CHROMABOND® HR-X polypropylene columns (45 µm)							
1 mL	730934P45		730935P45				30
3 mL		730936P45		730931P45			30
CHROMABOND® LV-HR-X (85 µm)							
15 mL				732132			30
Size →							
Minimum adsorbent weight →		M		L		Pack of	
		130 mg		360 mg			
CHROMAFIX® HR-X (85 µm)							
		731744		731745		50	
CHROMABOND® MULTI 96 HR-X							
		96 × 10 mg (45 µm)	96 × 25 mg (45 µm)	96 × 50 mg (85 µm)	Pack of		
		738530.010M	738530.025M	738530.050M	1		

Glass columns, LV columns and MULTI 96 on request.

For further applications on CHROMABOND® phases visit our online application database at <https://chromaappdb.mn-net.com/>



CHROMABOND® HR-XC strong cation exchanger

★ Key features

- High purity material, highest reproducibility and lowest blank values due to an optimized production process
- Outstanding recovery rates especially for the enrichment of basic analytes

🔧 Technical characteristics

- Strong acidic benzenesulfonic acid cation exchanger, exchange capacity 1.0 meq/g, base material polystyrene-divinylbenzene copolymer, pH stability 1 – 14
- Spherical particles, size 45 µm and 85 µm (standard), pore size 65 – 75 Å, very large specific surface 800 m²/g, pore volume 1.4 cm³/g, RP capacity 300 mg/g (caffeine in water)

✓ Recommended application

- Basic active ingredients from heavily matrix-contaminated samples like, e.g., urine, plasma, serum
- Fungicides from food
- Basic analytes like, e.g., amines
- Bases with pKa 2 – 10

Standard protocol for CHROMABOND® HR-XC

MN Appl. No. 304790

 **Column type:**
CHROMABOND® HR-XC, 3 mL, 200 mg
REF 730952

Sample pretreatment: adjust pH value if necessary

Column conditioning: 5 mL methanol

Equilibration: 5 mL water

Sample application: slowly aspirate sample through the column

Column washing 1: 2 mL 0.1 mol/L HCl in Wasser

Column washing 2 / Elution 1: 2 mL methanol (neutral and acidic compounds); if necessary, further washing steps

Elution 2: after drying 5 mL methanol – 5 % NH₃ (basic compounds)

Further analysis: if necessary, evaporate and redissolve in a suitable solvent; HPLC or GC

Fractionation of acidic, neutral and basic analytes from serum

MN Appl. No. 304780

 **Column type:**
CHROMABOND® HR-XC, 3 mL, 200 mg
REF 730952

Sample: 1 mL spiked matrix, acidified with 200 µL 2 % H₃PO₄

Column conditioning: 5 mL methanol, then 5 mL water

Sample application: slowly aspirate sample through the column

Column washing: 2 mL 0.1 mol/L HCl

Elution: 2.5 mL methanol (fraction A: neutral and acidic analytes); then 5 mL methanol – NH₃ 90:10, v/v (fraction B: basic analytes)

Further analysis:

for fraction A:





HPLC, e.g., on NUCLEODUR® C₁₈ Gravity, see MN Appl. No. 122230;

for fraction B:

HPLC on NUCLEODUR® C₈ Gravity, see MN Appl. No. 118520

Recovery rates [%]

Fraction A: neutral and acidic analytes		Fraction B: basic analytes			
Compound	HR-XC	Compound	HR-XC	Oasis® MCX	Strata™ X-C
Suprofen	108	Doxepin	101	68	82
Naproxen	85	Imipramine	95	71	85
Tolmetin	73	Amitriptyline	94	72	78
Phenobarbital	108	Trimipramine	92	70	81
Indomethacin	33				
Hexobarbital	80				

Volume	Adsorbent weight →					Pack of	
	30 mg	60 mg	100 mg	150 mg	200 mg		500 mg
	CHROMABOND® HR-XC polypropylene columns (85 µm)						
	1 mL	730969		730049		30	
	3 mL		730956			730952	730953
6 mL				730957		730955	30
	CHROMABOND® HR-XC polypropylene columns (45 µm)						
	1 mL	730969P45		730049P45		30	
	3 mL		730956P45			730952P45	30
	Size →	S		M		L	Pack of
	Minimum adsorbent weight →	50 mg		140 mg		400 mg	
	CHROMAFIX® HR-XC cartridges (85 µm)						
		731755		731756		731757	50

Glass columns, LV columns and MULTI 96 on request.

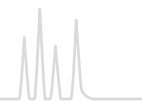

CHROMABOND[®] HR-XA strong anion exchanger

★ Key features

- High purity material with highest reproducibility and lowest blank values due to an optimized production process
- Outstanding recovery rates especially for the enrichment of acidic analytes

🔧 Technical characteristics

- Strong basic quaternary ammonium anion exchanger, exchange capacity 0.25 meq/g, pKa ~ 18, base material polystyrene-divinylbenzene copolymer, pH stability 1 – 14
- Spherical particles, size 45 µm and 85 µm (standard), pore size 55 – 65 Å, very large specific surface 850 m²/g, pore volume 1.4 cm³/g, RP capacity 350 mg/g (caffeine in water)

✓ Recommended application

- Acidic active ingredients from heavily matrix-contaminated samples like, e.g., urine, plasma, serum
- Phenolic acids
- Acidic herbicides
- Weak / medium-strength acids with pKa 2 – 8

Standard protocol for CHROMABOND[®] HR-XA

MN Appl. No. 304970

 Column type:
CHROMABOND[®] HR-XA, 3 mL, 200 mg
REF 730951

Sample pretreatment:
individual sample preparation with reference to analytes and matrix

Column conditioning: 5 mL methanol

Equilibration: 5 mL water



Sample application: slowly aspirate sample through the column

Column washing 1: 2 mL 0.1 mol/L NaOH in water

Column washing 2 / Elution 1: 2 mL methanol (neutral and basic compounds), if necessary, further washing steps

Elution 2: after drying 5 mL methanol – 1 to 10 % formic acid (acidic compounds)

Further analysis: if necessary, evaporate and redissolve in a suitable solvent; HPLC or GC MN Appl. No. 304970

	Volume	Adsorbent weight →					Pack of	
		30 mg	60 mg	100 mg	150 mg	200 mg		500 mg
	CHROMABOND[®] HR-XA polypropylene columns (85 µm)							
	1 mL	730968		730727			30	
	3 mL		730950			730951	730954	30
	6 mL				730958		730966	30
	CHROMABOND[®] HR-XA polypropylene columns (45 µm)							
	1 mL	730968P45		730727P45				30
3 mL		730950P45			730951P45		30	
	Size →	S		M		L	Pack of	
	Minimum adsorbent weight →	70 mg		180 mg		510 mg		
	CHROMAFIX[®] HR-XA cartridges (85 µm)							
		731768		731769		731770	50	

Glass columns, LV columns and MULTI 96 on request.

For further applications on CHROMABOND[®] phases visit our online application database at <https://chromaappdb.mn-net.com/>



CHROMABOND® HR-XCW weak cation exchanger

★ Key features

- High purity material, highest reproducibility and lowest blank values due to an optimized production process
- Outstanding recovery rates especially for enrichment of strongly basic analytes

🔧 Technical characteristics

- Weak acidic carboxylic acid cation exchanger, exchange capacity > 0.7 meq/g, pKa ~ 5, base material spherical PS/DVB copolymer, pH stability 1 – 14
- Spherical particles, size 45 µm and 85 µm (standard), pore size 50 – 60 Å very large specific surface 850 m²/g, pore volume 1.2 – 1.4 cm³/g, RP capacity 350 mg/g (caffeine in water)

✓ Recommended application

- Basic compounds like quaternary amines
- Active ingredients from heavily matrix-contaminated samples like, e.g., urine, plasma, serum
- Strong bases with pKa > 10

Standard protocol for CHROMABOND® HR-XCW

MN Appl. No. 305300

 Column type:
CHROMABOND® HR-XCW, 3 mL, 200 mg
REF 730739

Sample pretreatment:

individual sample preparation with reference to analytes and matrix

Column conditioning: 5 mL methanol, 5 mL water

Sample application:



slowly aspirate sample through the column

Column washing 1: 2 mL acidified water

Column washing 2 / Elution 1: 2 mL methanol (neutral and acidic compounds), further washing steps if necessary

Elution 2: after drying 2 x 2 mL methanol – 1 to 5 % formic acid (strongly basic compounds)

Further analysis: if necessary, evaporate and redissolve in a suitable solvent; HPLC or GC

Volume	Adsorbent weight →					Pack of
	30 mg	60 mg	100 mg	150 mg	200 mg	500 mg
	CHROMABOND® HR-XCW polypropylene columns (85 µm)					
	1 mL	730731		730733		
	3 mL		730735		730739	730741
	6 mL			730737		730743
	CHROMABOND® HR-XCW polypropylene columns (45 µm)					
	1 mL	730731P45		730733P45		
3 mL		730735P45			730739P45	
	Size →	S		M		L
	Minimum adsorbent weight →	60 mg		160 mg		450 mg
	CHROMAFIX® HR-XCW cartridges (85 µm)					
		731774		731775		731776

Glass columns, LV columns and MULTI 96 on request.

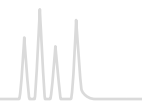

CHROMABOND[®] HR-XAW weak anion exchanger

★ Key features

- High purity material with highest reproducibility and lowest blank values due to an optimized production process
- Outstanding recovery rates especially for enrichment of acidic analytes

🔧 Technical characteristics

- Weak basic secondary and tertiary ammonium anion exchanger, exchange capacity > 0.5 meq/g, pKa ~ 6, base material spherical PS/DVB copolymer, pH stability 1 – 14
- Spherical particles, size 45 µm and 85 µm (standard), pore size 55 – 65 Å very large specific surface 850 m²/g, pore volume 1.2 – 1.4 cm³/g, RP capacity 350 mg/g (caffeine in water)

✓ Recommended application

- Perfluorinated surfactants
- Acidic compounds like sulfonates
- Active ingredients from heavily matrix-contaminated samples like, e.g., urine, plasma, serum
- Strong acids with pKa < 1

Standard protocol for CHROMABOND[®] HR-XAW

MN Appl. No. 305200

 **Column type:**
CHROMABOND[®] HR-XAW, 3 mL, 200 mg
REF 730748

Sample pretreatment:
individual sample preparation with reference to analytes and matrix

Column conditioning: 5 mL methanol

Equilibration: 5 mL water

Sample application:
slowly aspirate sample through the column

Column washing 1: 25 mmol/L ammonium acetate

Column washing 2 / Elution 1: 2 mL methanol (neutral and basic compounds), if necessary, further washing steps

Elution 2: after drying 2 x 2 mL methanol – 1 to 5 % ammonia (strongly acidic compounds)

Further analysis: if necessary, evaporate and redissolve in a suitable solvent; HPLC or GC

Analysis of perfluorinated surfactants from water

MN Appl. No. 305140

Application in accordance with DIN 38407-42

 **Column type:**
CHROMABOND[®] HR-XAW, 3 mL, 60 mg
REF 730747

Sample: 500 mL water, spiked with 1 mL standard solution (20 µg/L of each compound)

Column conditioning:

2 mL methanol + 5 % ammonia, then 2 mL methanol, finally 2 mL water

Sample application:

slowly aspirate sample through the column



Column washing: 2 mL water, then 2 mL acetone – acetonitrile – formic acid (50:50:1, v/v/v), finally 2 mL methanol

Elution: 2 mL methanol with 5 % ammonia

Further analysis: evaporate to dryness in a stream of nitrogen under slight heating, and redissolve in a suitable solvent for HPLC

Recovery rates [%]

Compound	Recovery
Perfluoropropionic acid (PFPrA)	103
Perfluoropentanoic acid (PFPeA)	94
Perfluorohexanoic acid (PFHxA)	94
Perfluorooctanoic acid (PFOA)	95
Perfluorooctane sulfonate K salt (PFOS)	81
Perfluorododecanoic acid (PFDoDA)	82

Volume	Adsorbent weight →					Pack of	
	30 mg	60 mg	100 mg	150 mg	200 mg		500 mg
	CHROMABOND [®] HR-XAW polypropylene columns (85 µm)						
	1 mL	730728		730729		30	
	3 mL		730747		730748	730744	30
	6 mL			730749		730745	30
	CHROMABOND [®] HR-XAW polypropylene columns (45 µm)						
	1 mL	730728P45		730729P45		30	
	3 mL		730747P45		730748P45		30
	Size →	S		M		L	Pack of
	Minimum adsorbent weight →	50 mg		120 mg		360 mg	
	CHROMAFIX [®] HR-XAW cartridges (85 µm)						
		731771		731772		731773	50

Glass columns, LV columns and MULTI 96 on request.



CHROMABOND® WAX weak anion exchanger ideal for PFAS enrichment

★ Key features

- High purity material with highest reproducibility and lowest blank values due to an optimized production process (PFAS contamination test included in CoA)
- Outstanding recovery rates especially for the enrichment of acidic analytes like short-chain PFAS

🔧 Technical characteristics

- Weak mixed-mode anion exchanger, ion exchange capacity ≥ 0.80 meq/g, $pK_a > 8$, base material polystyrene-divinylbenzene copolymer, pH stability 1 – 14
- Spherical particles, size $30 \mu\text{m}$, pore size $60 - 80 \text{ \AA}$, large specific surface area $\geq 800 \text{ m}^2/\text{g}$

✓ Recommended application

- Acidic analytes from various samples
- Strong acids with $pK_a < 1$
- Per- and polyfluoroalkyl substances (PFAS) from drinking water, soil, sediment, and wastewater e.g. according to EPA Method 533, EPA Draft 1633 and ISO 21675:2019

Volume	Adsorbent weight →			Pack of
	60 mg	150 mg	200 mg	
CHROMABOND® WAX polypropylene columns (30 μm)				
3 mL	7300014		7300015	30
6 mL		7300011		30
CHROMABOND® WAX polypropylene columns (30 μm) BIGpacks				
3 mL	7300014.250			250
6 mL		7300011.250		250



PFAS in aqueous samples according to EPA Draft Method 1633

MN Appl. No. 306950

Column type:
CHROMABOND® WAX, 30 μm , 6 mL/150 mg
REF 7300011

Sample: pH 6.5 ± 0.5 , adjust pH with 50 % formic acid or ammonium hydroxide

Column conditioning: 15 mL of 1 % methanolic ammonium hydroxide, followed by 5 mL of 0.3 M formic acid

Sample application: 500 mL water sample with a flow rate of 5 mL/min

Washing step: Pass those rinses through the cartridge using vacuum

Elution: 5 mL of 1 % methanolic ammonium hydroxide

Further analysis:

for fraction A:

HPLC on NUCLEODUR® PFAS, see MN Appl. No. 129370

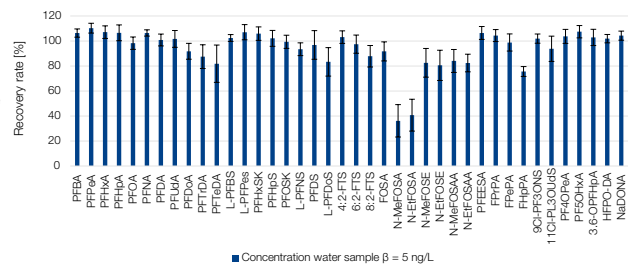

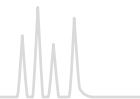

CHROMABOND® Easy polar, bifunctionally modified polystyrene-divinylbenzene copolymer

★ Key features

The Easy effect:

- Without preconditioning
- Due to bifunctional modification much more hydrophilic than conventional polystyrene-divinylbenzene polymers
- Easily wettable with water

🔧 Technical characteristics

- Polar modified polystyrene-divinylbenzene copolymer with a weak anion exchanger, specific surface 650–700 m²/g, particle size 80 µm, pore size 50 Å, pH stability 1–14

✓ Recommended application

- Polar herbicides and pesticides from water (acidic, neutral, basic), polar phenols from water, polyaromatic compounds, polychlorinated biphenyls
- Drug analysis from urine, blood, serum, plasma
- Pharmaceuticals and active ingredients from tablets, creams

Recovery of pesticides

MN Appl. No. 303220

Private communication Mr. Kühn, GUB, Waldshut Tiengen, Germany

Column type:
CHROMABOND® Easy, 3 mL, 200 mg
REF 730754

Column conditioning:
1 mL water, 3 mL methanol, 1 mL water

Sample application:
aspirate the sample through the column

Elution:
3 x 1 mL acetone

Further analysis: HPLC with NUCLEOSIL® 120-5 C₁₈

Recovery rates [%]

Compound	Recovery	Compound	Recovery
Desisopropylatrazine	90	Metalaxyl	96
2,6-Dichlorobenzamide	93	Isoproturon	94
Desethylatrazine	93	Diuron	94
Hexazinone	69	Metazachlor	97
Terbacil	65	Propazine	95
Simazine	81	Terbutylazine	93
Cyanazine	93	Linuron	96
Desethylterbutylazine	91	Metolachlor	97
Methabenzthiazuron	94	Triallate	61
Chlortoluron	91	Standard	64
Atrazine	92		

	Volume	Adsorbent weight →					Pack of
		30 mg	60 mg	100 mg	200 mg	500 mg	
	CHROMABOND® Easy polypropylene columns						
	1 mL	730751					30
	3 mL		730753		730754	730759	30
	6 mL				730755	730756	30
	15 mL					730757	20
	CHROMABOND® Easy polypropylene columns · BIGpacks						
	3 mL				730754.250		250
	6 mL				730755.250		250
						96 x 50 mg	Pack of
	CHROMABOND® MULTI 96 Easy					738520.050M	1

For further applications on CHROMABOND® phases visit our online application database at <https://chromaappdb.mn-net.com/>



CHROMABOND® HR-P polystyrene-divinylbenzene adsorbent resin

★ Key features

- Very high binding capacity, up to 30 % of adsorbent weight (for comparison: silica adsorbents about 3 %)

🔧 Technical characteristics

- Highly porous polystyrene-divinylbenzene copolymer, specific surface 1200 m²/g, particle size 50 – 100 µm

✓ Recommended application

- Aromatic compounds, phenols from water, nitroaromatics from water, pesticides from water, PAHs from oil

Aromatic amines from water samples

MN Appl. No. 301810

Private communication M. Leß, T.C. Schmidt, Department of Chemistry, University Marburg, 1997

Compounds investigated: aromatic amines

Column type:

CHROMABOND® HR-P, 3 mL, 200 mg

REF 730108

Sample pretreatment: adjust to pH 9 using 10 mol/L NaOH

Column conditioning: 2 mL each of methanol, acetonitrile and 10⁻⁵ mol/L aqueous sodium hydroxide solution

Sample application: aspirate sample through the column with about 10 mL/min

Column washing: wash with 2 mL dist. water, dry 5 min under vacuum

Elution: 3 x 1 mL methanol – acetonitrile (1:1, v/v)

For recovery rates of numerous aromatic amines please see application 301810 at www.mn-net.com/apps

	Volume	Adsorbent weight →			Pack of	
		100 mg	200 mg	500 mg		1 g
	CHROMABOND® HR-P polypropylene columns					
	3 mL		730108	730117	30	
	6 mL		730119	730111	730118	30
	CHROMABOND® HR-P polypropylene columns · BIGpack					
	3 mL		730108.250		250	
	6 mL			730111G	30	
	CHROMABOND® LV-HR-P					
	15 mL		732108		30	
	Size →		M	L	Pack of	
	Minimum adsorbent weight →		130 mg	380 mg		
	CHROMAFIX® HR-P cartridges					
			731840	731841	50	

For further applications on CHROMABOND® phases visit our online application database at <https://chromaappdb.mn-net.com/>

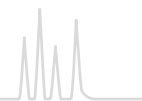

CHROMABOND® PS-RP / PS-OH⁻ / PS-H⁺ / PS-Mix / PS-Ag⁺ / PS-Ba²⁺

phases for RP and ion chromatography

★ Key features

- Very low degree of swelling, thus very well suited for chromatography, reliable function over the whole pH range from 0–14

🔧 Technical characteristics

- Base material high purity polystyrene-divinylbenzene copolymers (PS/DVB), pore size 100 Å, particle size 100 µm
- Different modifications for different applications from the elimination of nonpolar compounds up to the removal of specific polar components

✓ Recommended application

- Removal of interfering compounds
- Improves chromatographic separation, if the interfering components overlap with the analyte in the chromatogram
- Improves lifetime of the chromatographic column, since interfering components can irreversibly block the column packing
- Enrichment of the analytes

Properties of the individual modifications

▪ PS-RP	hydrophobic PS/DVB copolymer	removal of organic interfering components from water
▪ PS-OH ⁻	strong PS/DVB anion exchanger, OH ⁻ form capacity 0.6 meq/g	removal or concentration of anions from water
▪ PS-H ⁺	strong PS/DVB cation exchanger, H ⁺ form capacity 2.9 meq/g	increasing the pH value in acidic samples
▪ PS-Mix	mixture of PS-OH ⁻ and PS-H ⁺	removal or concentration of cations from water
▪ PS-Ag ⁺	strong PS/DVB cation exchanger, Ag ⁺ form	desalting of water
▪ PS-Ba ²⁺	strong PS/DVB cation exchanger, Ba ²⁺ form	removal of halide ions from water
		removal of sulfate ions from water

Removal of halides from aqueous samples shown for the trace analysis of nitrate besides an excess of chloride or bromide

MN Appl. No. 301930 / 302750

Compounds investigated:

20 ppm nitrate besides 2500 ppm chloride or 500 ppm bromide

Column type:

CHROMAFIX® PS-Ag⁺ (M) 0.8 mL, min. 250 mg
REF 731865

Column conditioning: 1 mL dist. water

Sample application and Elution:

apply 4 x 1 mL sample fractions to the cartridge, discard 1st mL, collect 2nd, 3rd and 4th mL separately

Further analysis: HPLC with column 250 x 4 mm NUCLEOSIL® Anion II; eluent 2 mmol/L potassium hydrogen phthalate pH 6, 2 mL/min; detection: indirect UV, 280 nm (see applications 110440 and 110450 at www.mn-net.com/apps)

Phases	Adsorbent weight → 3 mL / 200 mg	3 mL / 500 mg	6 mL / 500 mg	6 mL / 900 mg	Pack of		
CHROMABOND® PS polypropylene columns							
PS-OH ⁻			730378		30		
PS-H ⁺	730690	730376	730377		30		
PS-Mix		730394		730310	30		
Phases	Size S	Minimum adsorbent weight →	Size M	Minimum adsorbent weight →	Size L	Minimum adsorbent weight →	Pack of
CHROMAFIX® PS cartridges							
PS-RP	731877	60 mg	731875	160 mg			50
PS-OH ⁻	731868	70 mg	731860	180 mg	731862	510 mg	50
PS-H ⁺	731867	90 mg	731861	220 mg	731863	620 mg	50
PS-Mix	731909	70 mg					50
PS-Ag ⁺	731866	100 mg	731865	250 mg			50
PS-Ba ²⁺	731871	100 mg	731870	250 mg			50



CHROMABOND® C₁₈ ec / C₁₈ ec f (f = fast flow) octadecyl silica, endcapped

★ Key features

- Very nonpolar, hydrophobic interactions with a wide variety of organic compounds
- Advantageous for the clean-up of samples with large structural variations (polarity differences)

🔧 Technical characteristics

- Base material silica, pore size 60 Å, particle size 45 µm for C₁₈ ec, 100 µm for C₁₈ ec f (for fast flow), specific surface 500 m²/g, pH stability 2–8
- Octadecyl phases, endcapped, carbon content 14 %

✓ Recommended application

- Nonpolar compounds
aflatoxins, amphetamines, antibiotics, antiepileptics, barbiturates, caffeine, drugs, preservatives, fatty acids, nicotine, PAHs, pesticides, PCBs, heavy metals, vitamins
- Very well suited for desalting of samples
- C₁₈ ec f for viscous samples

	Volume	Adsorbent weight → 100 mg	200 mg	500 mg	1 g	2 g	5 g	10 g	Pack of
	CHROMABOND® C₁₈ ec polypropylene columns								
	1 mL	730011							100
	3 mL		730012	730013					50
	6 mL			730014	730015	730141			30
	15 mL					730404			20
	45 mL						730405		20
	70 mL							730259	10
	CHROMABOND® C₁₈ ec polypropylene columns · BIGpacks								
	3 mL			730013.250					250
	6 mL			730014.250	730015.250				250
CHROMABOND® C₁₈ ec glass columns									
3 mL		730012G						50	
6 mL			730014G	730015G				30	
	CHROMABOND® LV-C₁₈ ec								
	15 mL		732012	732013					30
	Size →		S	M	L				Pack of
	Minimum adsorbent weight →		90 mg	230 mg	630 mg				
CHROMAFIX® C₁₈ ec cartridges									
			731804	731805	731806				50
			96 x 25 mg	96 x 50 mg				Pack of	
	CHROMABOND® MULTI 96 C₁₈ ec								
				738011.050M				1	
	CHROMABOND® C₁₈ ec adsorbent								
							730611		100 g
	Volume		Adsorbent weight →					Pack of	
			100 mg	200 mg	500 mg	1 g	2 g	5 g	10 g
	CHROMABOND® C₁₈ ec f polypropylene columns (fast flow)								
3 mL		730269						50	
6 mL			730016	730010				30	
	CHROMABOND® C₁₈ ec f adsorbent (fast flow)								
							730613		100 g



CHROMABOND[®] reversed phases

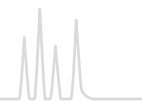

CHROMABOND[®] C₁₈ / C₁₈ f (f = fast flow) octadecyl silica

★ Key features

- Similar to C₁₈ ec, however possesses more free silanols (SiOH), which allow secondary interactions with polar groups of the analytes

🔧 Technical characteristics

- Base material silica, pore size 60 Å, particle size 45 µm for C₁₈, 100 µm for C₁₈ f (for fast flow), specific surface 500 m²/g, pH stability 2–8
- Octadecyl phases, not endcapped, carbon content 14 %

✓ Recommended application

- Nonpolar compounds, pesticides
- C₁₈ f for viscous samples

	Volume	Adsorbent weight → 100 mg	200 mg	500 mg	1 g	2 g	5 g	10 g	Pack of											
	CHROMABOND[®] C₁₈ polypropylene columns																			
	1 mL	730001							100											
	3 mL		730002	730003					50											
	6 mL			730004	730005	730130			30											
	15 mL					730028			20											
	45 mL						730400		20											
	70 mL							730261	10											
	CHROMABOND[®] C₁₈ polypropylene columns · BIGpacks																			
	3 mL			730003.250					250											
	6 mL			730004.250	730005.250				250											
	Size →		S		M		L		Pack of											
	Minimum adsorbent weight →		90 mg		200 mg		560 mg													
	CHROMAFIX[®] C₁₈ cartridges																			
			731801		731802		731803		50											
	CHROMABOND[®] MULTI 96 C₁₈								Pack of											
							96 × 100 mg													
							738001.100M		1											
	CHROMABOND[®] C₁₈ adsorbent								Pack of											
							730602			100 g										
	Volume		Adsorbent weight →		100 mg		200 mg		500 mg		1 g		2 g		5 g		10 g		Pack of	
	CHROMABOND[®] C₁₈ f polypropylene columns (fast flow)																			
	3 mL				730402		730008												50	
	6 mL				730403		730009												30	
	CHROMABOND[®] C₁₈ f adsorbent (fast flow)																		Pack of	
																				730612

For further applications on CHROMABOND[®] phases visit our online application database at <https://chromaappdb.mn-net.com/>



CHROMABOND® C₁₈ Hydra octadecyl silica for polar analytes

★ Key features

- Special octadecyl phase for polar analytes, not endcapped, carbon content 15 %

🔧 Technical characteristics

- Base material silica, pore size 60 Å, particle size 45 µm, specific surface 500 m²/g, pH stability 2–8

✓ Recommended application

- Polar compounds like pesticides and their polar degradation products, phenols, phenoxy-carboxylic acids

Pesticides from water

MN Appl. No. 302060

Compounds investigated: triazines and carboxylic amides

📏 Column type:

CHROMABOND® C₁₈ Hydra, 6 mL, 2 g

REF 730301

Sample pretreatment: adjust 1000 mL water to pH 7–8 with diluted NH₃ and add 100 µL of the internal standards (1 µg/L).

Column conditioning: 2 x 5 mL methanol, then 2 x 5 mL dist. water

Sample application: force or aspirate the sample through the column. Then dry for 2 h with 2 bar N₂.

Elution: slowly aspirate 10 mL methanol through the column. Evaporate the eluate to dryness in a tapered flask with a rotation evaporator at 30 °C and store in a refrigerator for ~15 min. Redissolve the residue in 200 µL cold, fresh *n*-hexane and transfer the solution to a conic HPLC vial (e.g., REF 702891). Store the solution in a refrigerator until chromatography.

Recovery rates: between 95 and 100 %

Further analysis: GC with OPTIMA® δ-3 or OPTIMA® δ-6 (e.g., application 250420) or HPLC in accordance with EN ISO 11369:1997 on NUCLEOSIL® 120-3 C₁₈ (application 110880)

Volume	Adsorbent weight →	200 mg	500 mg	1 g	2 g	3 g	Pack of
	CHROMABOND® C ₁₈ Hydra polypropylene columns						
	3 mL	730296	730297				50
	6 mL		730299	730300	730301		30
	CHROMABOND® C ₁₈ adsorbent						
						730628	100 g

For further applications on CHROMABOND® phases visit our online application database at <https://chromaappdb.mn-net.com/>



CHROMABOND® reversed phases

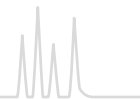

CHROMABOND® C₈ octyl silica

★ Key features



- Similar to C₁₈, however slightly more polar
- Secondary interactions with polar compounds are more pronounced due to shorter alkyl chains

🔧 Technical characteristics

- Base material silica, pore size 60 Å, particle size 45 µm, specific surface 500 m²/g, pH stability 2–8
- Octyl phase, not endcapped, carbon content 8 %

✓ Recommended application

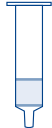
- Pesticides, PCBs

	Volume	Adsorbent weight →			Pack of
		100 mg	200 mg	500 mg	
	CHROMABOND® C ₈ polypropylene columns				
	1 mL	730021			100
	3 mL		730022	730023	50
	6 mL			730024	30
	CHROMABOND® C ₈ adsorbent				
				730601	100 g

CHROMABOND® C₄ butyl silica

★ Key features



- Slightly more polar than C₁₈ or C₈, due to shorter alkyl chains the silica surface is not completely shielded

🔧 Technical characteristics

- Base material silica, pore size 60 Å, particle size 45 µm, specific surface 500 m²/g, pH stability 2–8
- Butyl phase, not endcapped, carbon content 7 %

✓ Recommended application

- Compounds, which are too strongly retained on C₁₈ or C₈ e.g., analgetics from blood

	Volume	Adsorbent weight →		Pack of
		100 mg	500 mg	
	CHROMABOND® C ₄ polypropylene columns			
	1 mL	730225		100
	3 mL		730227	50
	Size →		M	Pack of
	Minimum adsorbent weight →		200 mg	
	CHROMAFIX® C ₄ cartridges			
				731741
	CHROMABOND® C ₄ adsorbent			
			730651	100 g

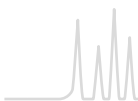

CHROMABOND[®] reversed phases



CHROMABOND[®] C₂ dimethyl silica

★ Key features



- Similar to C₄

🔧 Technical characteristics

- Base material silica, pore size 60 Å, particle size 45 µm, specific surface 500 m²/g, pH stability 2–8
- Dimethyl phase, not endcapped, carbon content 4 %

✓ Recommended application

- E.g., antiepileptics from plasma

	Volume	Adsorbent weight → 100 mg	500 mg	Pack of
	CHROMABOND [®] C ₂ polypropylene columns 3 mL		730221	50
	CHROMABOND [®] C ₂ adsorbent		730652	100 g

CHROMABOND[®] C₆H₅ phenyl silica

★ Key features

- Polarity similar to C₈
- In addition to hydrophobic interactions more selective adsorption is possible by π-π interactions due to the electron density of the phenyl ring.

🔧 Technical characteristics

- Base material silica, pore size 60 Å, particle size 45 µm, specific surface 500 m²/g, pH stability 2–8
- Phenyl phase, carbon content 8 %

✓ Recommended application

- Aflatoxins, caffeine, phenols

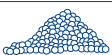
	Volume	Adsorbent weight → 100 mg	500 mg	Pack of
	CHROMABOND [®] C ₆ H ₅ polypropylene columns 3 mL		730084	50
	CHROMABOND [®] C ₆ H ₅ adsorbent		730606	100 g

For further applications on CHROMABOND[®] phases visit our online application database at <https://chromaappdb.mn-net.com/>



CHROMABOND[®] normal phases

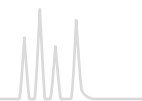

CHROMABOND[®] SiOH unmodified silica

★ Key features

- Very polar
- Adsorbs humidity from air, for this reason it should be kept well closed and if necessary dried before use
- Due to its high affinity for polar compounds it should not be conditioned with polar (e.g., methanol) or water-containing solvents.

🔧 Technical characteristics

- Unmodified, weakly acidic silica, pore size 60 Å, particle size 45 µm, specific surface 500 m²/g, pH stability 2–8

✓ Recommended application

- Aflatoxins, chloramphenicol, pesticides, steroids, vitamins

	Volume	Adsorbent weight → 100 mg	200 mg	500 mg	1 g	2 g	5 g	10 g	Pack of
	CHROMABOND [®] SiOH polypropylene columns								
	1 mL	730071							100
	3 mL		730214	730073					50
	6 mL			730070	730075	730107			30
	15 mL					730217			20
	45 mL						730406		20
	70 mL							730072	10
	CHROMABOND [®] SiOH polypropylene columns · BIGpacks								
	3 mL			730073.250					250
	6 mL				730075.250	730107.250			250
	CHROMABOND [®] SiOH glass columns								
	3 mL		730214G	730073G					50
	6 mL			730070G	730075G	730107G			30
	Size →				L				Pack of
	Minimum adsorbent weight →				490 mg				
	CHROMAFIX [®] SiOH cartridges								
							731830		50
	CHROMABOND [®] MULTI 96 SiOH								
							96 × 100 mg		Pack of
	CHROMABOND [®] SiOH adsorbent								
							738071.100M		1
							730608		100 g

For further applications on CHROMABOND[®] phases visit our online application database at <https://chromaappdb.mn-net.com/>

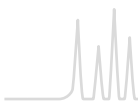

CHROMABOND® normal phases



CHROMABOND® NH₂ aminopropyl silica

★ Key features

- Polar, weak anion exchanger

🔧 Technical characteristics

- Base material silica, pore size 60 Å, particle size 45 µm, specific surface 500 m²/g, pH stability 2–8
- Aminopropyl phase, carbon content 3.5 %

✓ Recommended application

- Trace elements, lipids

Metals: trace elements from water

MN Appl. No. 301910

Compounds investigated: Al, Be, Cu, Cr(VI), Mo(VI), V(V)

Column type:

CHROMABOND® NH₂, 3 mL, 500 mg

REF 730033

Sample pretreatment:



mix 100 mL water sample with 5 mL 0.001 % alizarinsulfonic acid solution and adjust to pH 5.5 with acetic acid or sodium acetate

Column conditioning: 2 column volumes 1 mol/L nitric acid, then 2 column volumes dist. water

Sample application: force or aspirate sample through the column with 3–4 mL/min

Column washing: 2 mL dist. water; dry column under vacuum for 4 min

Elution: 2 column volumes 2 mol/L nitric acid

	Volume	Adsorbent weight →			Pack of
		100 mg	500 mg	1 g	
	CHROMABOND® NH₂ polypropylene columns				
	1 mL	730031			100
	3 mL		730033		50
	6 mL		730180	730626	30
	CHROMABOND® NH₂ glass columns				
	3 mL		730033G		50
	6 mL		730180G	730626G	30
	CHROMABOND® NH₂ adsorbent			730603	100 g



CHROMABOND® normal phases

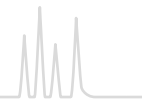

CHROMABOND® OH (Diol) diol silica

★ Key features



- Polar, properties similar to SiOH

🔧 Technical characteristics

- Base material silica, pore size 60 Å, particle size 45 µm, specific surface 500 m²/g, pH stability 2–8
- Diol phase, carbon content 5.5 %

✓ Recommended application

- Antibiotics, prostaglandins

	Volume	Adsorbent weight →	500 mg	Pack of
	CHROMABOND® OH (Diol) polypropylene columns			
	3 mL		730053	50
	6 mL		730418	30
	CHROMABOND® OH (Diol) adsorbent			
			730605	100 g

Glass columns, LV columns, CHROMAFIX® cartridges and MULTI 96 on request.

CHROMABOND® CN cyanopropyl silica

★ Key features



- In addition to weak hydrophobic interactions selective interactions are possible due to the high electron density of the CN group.
- Polar to midpolar

🔧 Technical characteristics

- Base material silica, pore size 60 Å, particle size 45 µm, specific surface 500 m²/g, pH stability 2–8
- Cyanopropyl phase, carbon content 5.5 %

✓ Recommended application

- Cyclosporins, carbohydrates

	Volume	Adsorbent weight →	500 mg	Pack of
	CHROMABOND® CN polypropylene columns			
	1 mL	100 mg	730061	100
	3 mL		730063	50
	CHROMABOND® CN adsorbent			
			730607	100 g

Glass columns, LV columns, CHROMAFIX® cartridges and MULTI 96 on request.

For further applications on CHROMABOND® phases visit our online application database at <https://chromaappdb.mn-net.com/>



CHROMABOND® HILIC zwitterionic polar phase with ammonium sulfonic acid modification

Technical characteristics

- Basic material silica, pore size 60 Å, particle size 45 µm, specific surface 500 m²/g, pH stability 2–8

Hydrophilic interaction liquid chromatography

A water-rich layer is formed on the surface of the adsorbent, which enables stronger interactions for polar than for nonpolar analytes. Thus polar analytes are more strongly retained than nonpolar compounds. This behavior is inverse (orthogonal) to RP materials like, e.g., CHROMABOND® C₁₈ ec.

In HILIC-HPLC (e.g., NUCLEODUR® HILIC) increase of the portion of water in the eluent results in reduction of the retention times – consequently enrichment in SPE is the more difficult, the higher the portion of water in the sample matrix. Elution of the analytes is achieved with water.

Recommended application

- Polar organic acids and bases, polar natural compounds, nucleosides, oligonucleotides, amino acids, peptides, water-soluble vitamins

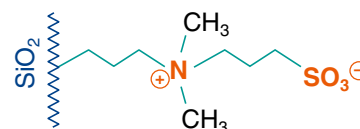

Standard protocol

MN Appl. No. 305580

Column type:
CHROMABOND® HILIC, 3 mL, 500 mg
REF 730593

Sample pretreatment: A high part of acetonitrile in the sample is recommended. Aqueous samples must be diluted with acetonitrile (recommended: water – acetonitrile (1:3, v/v)). Dioxane or THF can be used instead of acetonitrile.

Column conditioning: 1 mL water (Do not let run the column dry!)

Equilibration: 6 mL acetonitrile or the organic solvent, dilute the sample

Sample application: prepared sample is passed dropwise through the column

Column washing: if necessary 0.5–2 mL acetonitrile or the organic solvent, dilute the sample

Elution: 1–2 mL water (dependent on analyte)

Further analysis: if necessary, evaporate and redissolve in a suitable solvent; HPLC or GC

Creatinine and creatine from water: variation of the organic solvent

MN Appl. No. 305590

Column type:
CHROMABOND® HILIC, 3 mL, 500 mg
REF 730593

Sample pretreatment: 250 µL of aqueous sample are diluted with 750 µL tetrahydrofurane, 1,4-dioxane or acetonitrile

Column conditioning: 1 mL water (Do not let run the column dry!)

Equilibration: 5 mL tetrahydrofurane, 1,4-dioxane or acetonitrile

Sample application: prepared sample is passed dropwise through the column

Column washing: 3 x 1 mL tetrahydrofurane, 1,4-dioxane or acetonitrile

Elution: 1 mL water

Further analysis: HPLC with NUCLEODUR® HILIC according to MN Appl. No. 122990 (injection volume: 5 µL)

Recovery rates [%]

Compound

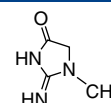

Creatinine

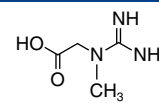

Creatine

Compound	Creatinine	Creatine
Tetrahydrofurane	105 %	101 %
1,4-dioxane	83 %	95 %
Acetonitrile	0 %	97 %

	Volume	Adsorbent weight → 500 mg	Pack of
	CHROMABOND® HILIC polypropylene columns		
	3 mL	730593	50
	6 mL	730594	30
	CHROMABOND® HILIC adsorbent		
		730643	100 g



CHROMABOND® normal phases

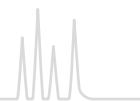



CHROMABOND® Alox A / Alox N / Alox B aluminum oxide, acidic, neutral, basic

★ Key features

- Alox A: aluminum oxide, acidic pH value 4 ± 0.5
- Alox N: aluminum oxide, neutral pH value 7 ± 0.5
- Alox B: aluminum oxide, basic pH value 9.5 ± 0.5

🔧 Technical characteristics

- Aluminum oxide, high purity, pore volume 0.90 mL/g, particle size 60–150 μm , specific surface 150 m^2/g

Phases	Volume	Adsorbent weight →			Pack of
		500 mg	1 g	4 g	
 CHROMABOND® Alox polypropylene columns					
Alox A	6 mL	730453	730017		30
Alox N	3 mL	730446			50
Alox N	6 mL		730139		30
Alox N	45 mL			730250	20
Alox B	6 mL		730020		30
CHROMABOND® Alox glass columns					
Alox N	6 mL		730139G		30
 Phase					
	Size →	M	L		Pack of
	Minimum adsorbent weight →	450 mg	1200 mg		
CHROMAFIX® Alox cartridges					
Alox N		731844	731845		50
 CHROMABOND® Alox adsorbents					
Alox A				730642	100 g
Alox N				730641	100 g
Alox B				730640	100 g



CHROMABOND® Florisil® magnesium silicate

Technical characteristics

- Matrix magnesium silicate (MgO – SiOH 15:85), high purity, particle size 150–250 µm

Recommended application

- Organic tin compounds, aliphatic carboxylic acids, PCBs, PAHs

	Volume	Adsorbent weight →	500 mg	1 g	2 g	Pack of
	CHROMABOND® Florisil® polypropylene columns					
	3 mL	730457	730081			50
	6 mL		730238	730082	730239	30
	CHROMABOND® Florisil® polypropylene columns · BIGpack					
	6 mL			730082.250		250
	CHROMABOND® Florisil® glass columns					
	6 mL		730238G	730082G	730239G	30
	Size → L					
	Minimum adsorbent weight →		700 mg			Pack of
	CHROMAFIX® Florisil® cartridges					
			731848			50
	CHROMABOND® Florisil® adsorbent					
					730622	100 g

LV columns and MULTI 96 on request.

CHROMABOND® PA polyamide 6

Technical characteristics

- Matrix polyamide 6, unmodified, high purity, particle size 40–80 µm

Recommended application

- Flavonoids, PAHs

	Volume	Adsorbent weight →	500 mg	1 g	Pack of
	CHROMABOND® PA polypropylene columns				
	3 mL		730126		50
	6 mL		730007	730127	30
	Size → S				
	Minimum adsorbent weight →		30 mg		
CHROMAFIX® PA cartridges					
			731849		50
	CHROMABOND® PA adsorbent				
				730660	100 g

Glass columns, LV columns and MULTI 96 on request.



CHROMABOND[®] ion exchangers based on silica

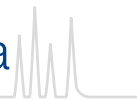

CHROMABOND[®] SA benzenesulfonic acid cation exchanger based on silica (SCX)

★ Key features

- Adsorbent with hydrophobic and π-π interactions (benzene ring)
- Ion exchange of organic compounds from aqueous matrix
- Elution of interesting compounds with solvent systems, which compensate the ionic and nonpolar interactions, e.g., methanolic HCl

🔧 Technical characteristics

- Base material silica, pore size 60 Å, particle size 45 µm, specific surface 500 m²/g, pH stability 2–8, benzenesulfonic acid modified silica, strongly acidic cation exchanger (capacity ~ 0.5 meq/g)

✓ Recommended application

- Amino acids, amines, chlorophyll, PCBs

Sulfonamides in meat and kidney

MN Appl. No. 302710

B. Pacciarelli et al., Mitt. Gebiete Lebensm. Hyg. 82 (1991) 45–55

Compounds investigated:

sulfaguandine, sulfanilamide, sulfadiazine, sulfathiazole, sulfapyridine, sulfamerazine, sulfamethizole, sulfadimidine, sulfamethoxypridazine, sulfachlorpyridazine, sulfadoxine, sulfadimethoxine

Column type:

CHROMABOND[®] SA (= SCX), 3 mL, 500 mg
REF 730077

Sample pretreatment: homogenize 10 g sample and 60 mL dichloromethane – acetone (1:1, v/v) for 30 s with a Polytron. Centrifuge the homogenate for 10 min at 2500 rpm. Filter the organic phase and wash the filter residue with a little dichloromethane – acetone. Add 5 mL glacial acetic acid to the filtered extract.

Column conditioning: apply 6 mL hexane and suck air until the column is dry (10 min). Then apply 6 mL dichloromethane – acetone – glacial acetic acid (10:10:1, v/v/v). Now the column must not run dry.

Sample application:

1/10 of the extract volume, flow rate about 2 mL/min; the column must not run dry

Column washing: 5 mL water, then 5 mL methanol; dry for 10 min under vacuum. Now suck NH₃ gas through the column until the acid is neutralized. To control the neutralization process, press air through the column: a wet pH paper should indicate a neutral or basic pH value.

Elution: 3 mL methanol (1–2 mL/min); carefully concentrate the eluate on a rotation evaporator (40 °C/100 mbar), dissolve the residue in 0.5 mL of 5.5 % acetonitrile in buffer (1.641 g sodium acetate in 1 L water, adjusted to pH 5 with glacial acetic acid) and centrifuge.

Further analysis: HPLC

	Volume	Adsorbent weight →			Pack of	
		100 mg	200 mg	500 mg		1 g
	CHROMABOND[®] SA polypropylene columns					
	1 mL	730076			100	
	3 mL		730275	730077	50	
	6 mL			730425	730212	30
	CHROMABOND[®] SA polypropylene columns · BIGpack					
	3 mL			730077.250	250	
	Size →		S	M	L	Pack of
	Minimum adsorbent weight →		80 mg	200 mg	580 mg	
	CHROMAFIX[®] SA cartridges					
			731831	731832	731833	50
CHROMABOND[®] SA adsorbent						
				730609	100 g	

Glass columns on request.

CHROMABOND® ion exchangers based on silica



CHROMABOND® SB quaternary ammonium anion exchanger based on silica (SAX)

★ Key features

- Not suited for very strong anions such as sulfonic acids because these are difficult to elute

🔧 Technical characteristics

- Base material silica, pore size 60 Å, particle size 45 µm, specific surface 500 m²/g, pH stability 2–8, silica modified with quaternary amine, strongly basic anion exchanger (capacity ~ 0.3 meq/g)

✓ Recommended application

- Organic acids, caffeine, saccharin

Vitamins: folic acid from food (e.g., wheat germs)

MN Appl. No. 300650

 Column type:
CHROMABOND® SB (≡ SAX), 3 mL, 500 mg
REF 730079





Sample pretreatment: homogenize 10 g food sample in 100 mL 0.01 mol/L phosphate buffer pH 7.4 and filter

Column conditioning: 2 column volumes *n*-hexane, then 2 column volumes methanol, finally 2 column volumes dist. water

Sample application: force or aspirate 10 mL of the filtrate through the column

Column washing: 2 column volumes dist. water

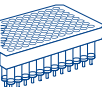
Elution: 5 mL 10 % sodium chloride in 0.1 mol/L sodium acetate buffer

	Volume	Adsorbent weight →			Pack of	
		100 mg	200 mg	500 mg	1 g	
	CHROMABOND® SB polypropylene columns					
	1 mL	730078			100	
	3 mL		730322	730079	50	
	6 mL			730426	730323 30	
	Size →			M	L	Pack of
	Minimum adsorbent weight →			180 mg	500 mg	
CHROMAFIX® SB cartridges						
				731835	731836	50
	CHROMABOND® MULTI 96 SB				Pack of	
					96 × 100 mg	
					738101.100M	1
	CHROMABOND® SB adsorbent					
					730610	100 g

Glass columns on request.



CHROMABOND® ion exchangers based on silica

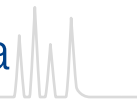

CHROMABOND® PCA propylcarboxylic acid cation exchanger based on silica (WCX)

★ Key features



- Weakly acidic cation exchanger (WCX)

🔧 Technical characteristics

- Base material silica, pore size 60 Å, particle size 45 µm, specific surface 500 m²/g, pH stability 2 – 8
- Propylcarboxylic acid modified silica

✓ Recommended application

- Strong cations

	Volume	Adsorbent weight → 500 mg	Pack of
	CHROMABOND® PCA polypropylene columns		
	6 mL	730483	30
	CHROMABOND® PCA adsorbent		
		730629	100 g

Glass columns, LV columns, CHROMAFIX® cartridges and MULTI 96 on request.

CHROMABOND® PSA propylsulfonic acid cation exchanger based on silica

★ Key features



- In contrast to the SA phase no π-π interactions

🔧 Technical characteristics

- Base material silica, pore size 60 Å, particle size 45 µm, specific surface 500 m²/g, pH stability 2 – 8
- Propylsulfonic acid modified silica, very strong cation exchanger (capacity ~ 0.7 meq/g)

✓ Recommended application

- Weak cations

	Volume	Adsorbent weight →	500 mg	1 g	Pack of
	CHROMABOND® PSA polypropylene columns				
	3 mL		730462		50
	CHROMABOND® PSA adsorbent				
				730630	100 g

Glass columns, LV columns, CHROMAFIX® cartridges and MULTI 96 on request.

For further applications on CHROMABOND® phases visit our online application database at <https://chromaappdb.mn-net.com/>



CHROMABOND® Drug special silica phase for drug analysis

Technical characteristics

- Base material silica, pore size 60 Å, particle size 45 µm, specific surface 500 m²/g, pH stability 2–8
- Special bifunctional modification – C₈: RP interaction
SA: strong cation exchanger / benzenesulfonic acid

Recommended application

- Enrichment of acidic, neutral and basic drugs from urine or plasma

Drugs from blood serum

MN Appl. No. 302020

W. Weinmann, M. Renz, C. Pelz, P. Brauchle, S. Vogt, S. Pollak, Blutalkohol 35 (1998), 1–9

Compounds investigated: benzoylcegonine, amphetamine, codeine, morphine

Column type:

CHROMABOND® Drug, 3 mL, 200 mg

REF 730168

Sample pretreatment: 0.1 mL blood serum are mixed with 1.4 mL of a 0.1 mol/L KH₂PO₄ buffer (pH 6) and centrifuged

Column conditioning: 2 mL methanol, then 2 mL 0.1 mol/L KH₂PO₄ buffer (pH 6)

Sample application: slowly force or aspirate the supernatant from the sample pretreatment through the column

Column washing: 2 mL 0.1 mol/L KH₂PO₄ buffer (pH 6), then 1 mL 0.1 mol/L acetic acid, then 2 mL methanol; finally dry the column first by centrifugation (2 min, 4000 U/min), then under vacuum for 10 min

Elution: 1.5 mL dichloromethane – 2-propanol – 25 % ammonia solution (80:20:2, v/v/v)

Further analysis: HPLC with NUCLEOSIL® 100-5 C₁₈ AB

(application 110240) or GC/MS after derivatization with perfluoropropanoic acid pentafluoropropanol, e.g., with column OPTIMA® 5 MS, 0.25 µm film, 30 m x 0.25 mm ID, (REF 726220.30)

	Volume	Adsorbent weight →		Pack of
		100 mg	200 mg	
	CHROMABOND® Drug polypropylene columns			
	1 mL	730681		100
	3 mL		730168	50
	CHROMABOND® Drug polypropylene columns · BIGpack			
	3 mL		730168.250	250

For further applications on CHROMABOND® phases visit our online application database at <https://chromaappdb.mn-net.com/>

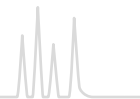

CHROMABOND® Drug II extraction of THC and derivatives, acidic analytes from biological fluids (urine, blood, etc.)

★ Key features

- Two primary retention mechanisms facilitate use of very strong interferent-eluting solvents, resulting in very pure extracts

🔧 Technical characteristics

- Base material silica, pore size 60 Å, particle size 45 µm, specific surface 500 m²/g, pH stability 2–8
- Special bifunctional modification –
C₈: RP interaction
SB: strong anion exchanger/
quaternary amine –N R₃⁺

✓ Recommended application

- Extraction of THC and derivatives from urine, blood, serum, plasma
- Acidic analytes from biological fluids

11-nor-Δ⁹-THC-carboxylic acid from urine

MN Appl. No. 303880

Compounds investigated: tetrahydrocannabinol, 11-nor-Δ⁹-THC-carboxylic acid

Column type:
CHROMABOND® Drug II, 3 mL, 200 mg
REF 730680

Sample pretreatment:

add 300 µL 10 mol/L potassium hydroxide solution and internal standard (for GC/MS deuterium labeled 11-nor-Δ⁹-THC-carboxylic acid) to 5 mL urine. Vortex the sample and then hydrolyze at 60 °C for 15 min. Cool sample and add 200 µL glacial acetic acid and 2 mL 50 mmol/L ammonium acetate solution. If necessary, adjust sample pH to 6–7.

Column conditioning:

2 mL methanol, 2 mL dist. water; equilibrate column with 2 mL 50 mmol/L ammonium acetate buffer

Sample application: slowly force or aspirate the sample through the column (1–2 mL/min)

Column washing: elute interferants with 10 mL methanol – water (1:1, v/v); dry the column for 10 min at high vacuum; further wash the column with 2 mL acetonitrile and dry for another 2 min

Elution: elute THC metabolites with 3 mL hexane – ethyl acetate – glacial acetic acid (75:25:1, v/v/v)

Recovery rates: 70–80 %

Further analysis: we recommend GC/MS on an OPTIMA® 5 MS column after derivatization with 50 µL Silyl-991 (REF 701480; BSTFA – TMCS 99:1) at 70 °C for 20 min; inject 1–2 µL onto the GC column.

	Volume	Adsorbent weight →	200 mg	Pack of
	CHROMABOND® Drug II polypropylene columns			
	3 mL		730680	50

For further applications on CHROMABOND® phases visit our online application database at <https://chromaappdb.mn-net.com/>



CHROMABOND® PFAS special phase for PFAS enrichment

★ Key features

- Special phase for the enrichment of PFAS from several matrices.
- Outstanding recovery rates especially for various types of PFAS due to several sorbent retention mechanisms.

🔧 Technical characteristics

- Special combination phase with weak anion exchanger, polymerbased material, pH stability 1 – 14
- Proprietary spherical particles

✓ Recommended application

- PFAS from water, textiles and sediments (contaminated soils).

Solid phase extraction of PFAS from water samples according to DIRECTIVE (EU) 2020/2184

MN Appl. No. 306980

Column type:
CHROMABOND® PFAS, 3 mL, 120 mg
REF 7300009

Sample pretreatment:

1. The pH value of the sample shall be adjusted to the pH value of 3 with acetic acid or ammonia solution, if necessary.
2. Add the spiking solution containing the internal standard substances to the water sample in the sample bottle [adding 0.5 ng of each (5813/20 PFAS Native Solution / Mixture)] and mix thoroughly by shaking.
3. Adjust methanol content of sample solution [0 %, 5 % and 10 % (percent by volume)].

Column conditioning: Add 4 mL of 0.1 % NH₃ in methanol solution, 4 mL of methanol and 4 mL of water to the cartridge.

Sample application: Add 200 mL water sample with a flow rate of 5 mL/min to the cartridge. (Do not let the sorbent material in the cartridge go dry and ensure it is immersed in water at all times.)

Bottle Rinse: Rinse the sample bottle wall and reservoir column with 4 mL of 0.1 % NH₃ in methanol solution.

Washing step: Add 4 mL of water and 4 mL of acetate buffer solution to the cartridge and discard the eluate.

Drying step: Dry the cartridge for 2 min with vacuum and centrifuge the cartridge at 1500 g for about 2 min.

Elution: Add 4 mL of 0.1 % NH₃ in methanol solution with a flow rate of 3 mL/min and collect the eluate into the sample tubes. Eluent exchange: Evaporate eluate to dryness at 40 °C under a stream of nitrogen and dissolve residue in 0.5 mL methanol.

Further analysis: HPLC MS/MS MN Appl. No. 129570

Analyte (Abbreviation)	Recovery rate (%) ± RSD (%) for 0 % methanol content in sample	Recovery rate (%) ± RSD (%) for 5 % methanol content in sample	Recovery rate (%) ± RSD (%) for 10 % methanol content in sample
PFBA	112.6 ± 6.0	108.1 ± 6.5	105.3 ± 2.3
PFPeA	116.6 ± 2.1	101.9 ± 2.0	102.2 ± 2.1
PFHxA	100.7 ± 1.4	100.5 ± 2.3	102.0 ± 0.7
PFHpA	95.1 ± 0.9	100.5 ± 2.4	100.8 ± 3.1
PFOA	92.0 ± 5.5	94.0 ± 14.6	88.0 ± 6.7
PFNA	86.8 ± 1.6	89.1 ± 6.3	70.0 ± 4.4
PFDA	68.9 ± 4.0	76.9 ± 6.9	50.5 ± 2.5
PFUnDA	60.5 ± 1.6	80.6 ± 11.1	47.9 ± 2.8
PFDODA	54.1 ± 1.1	79.5 ± 9.1	43.4 ± 2.4
PFTrDA	49.3 ± 1.0	107.1 ± 5.0	107.1 ± 5.0
PFBS	112.5 ± 2.4	100.1 ± 1.6	98.9 ± 1.5
PFPes	93.7 ± 2.4	100.1 ± 1.1	98.9 ± 1.5
PFHxS	106.0 ± 1.9	100.9 ± 1.3	98.9 ± 1.3
PFHpS	99.3 ± 0.7	94.6 ± 3.9	85.0 ± 5.6
PFOS	84.1 ± 2.4	82.8 ± 5.4	60.2 ± 4.4
PFNS	67.2 ± 1.1	77.8 ± 7.9	47.1 ± 2.0
PFDS	58.7 ± 0.8	75.3 ± 6.7	43.8 ± 1.6
PFUdS	59.8 ± 1.2	72.8 ± 6.2	45.3 ± 1.3
PFDoS	56.3 ± 1.2	75.3 ± 5.9	45.3 ± 1.5
PFTrDS	55.0 ± 0.3	74.9 ± 3.9	47.2 ± 1.5

Volume	Adsorbent weight → 120 mg	300 mg	Pack of
CHROMABOND® PFAS polypropylene columns			
3 mL	7300009		30
6 mL		730283	30
CHROMABOND® PFAS polypropylene columns BIGpack			
3 mL	7300009.250		250
6 mL		730283.250	250

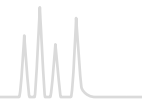

CHROMABOND® HR-P-AOX AOX from waters with high salt loads (DIN 38409-H22)

Technical characteristics

- Special PS/DVB phase

Recommended application

- Extraction of AOX (adsorbable organically bonded halogens) from waters containing high salt loads or organic pollutants in accordance with DIN 38409-H22

AOX from water (DIN 38409-H₂₂)

MN Appl. No. 302080

Column type:

CHROMABOND® HR-P-AOX, 6 mL, 500 mg

REF 730111.AOX

Column conditioning: 5 mL methanol, 10 mL dist. water

Do not let the column run dry!

Sample application: force or aspirate 100 mL original or diluted sample (pH 1) through the column (3–5 mL/min). Do not let the column run dry!

Column washing: 50 mL nitrate rinsing solution (dissolve 17 g NaNO₃ in 100 mL dist. water, add 1.4 mL HNO₃ 10 mol/L, fill up to 1000 mL; take 50 mL and fill to 1000 mL with dist. water). Discard the flowthrough.

Elution: slowly aspirate 1 × 1 mL, then 1 × 4 mL methanol and 10 mL dist. water through the column.

Collect eluates in 100 mL volumetric flask and fill to 100 mL with dist. water.

	Volume	Adsorbent weight → 200 mg	500 mg	Pack of
		CHROMABOND® HR-P-AOX polypropylene columns 6 mL	730119.AOX	730111.AOX

CHROMABOND® C₁₈ PAH octadecyl silica for PAH analysis

Technical characteristics

- Base material silica, pore size 60 Å, particle size 45 µm, specific surface 500 m²/g, pH stability 2–8
- Special octadecyl modification for the enrichment of PAHs, not endcapped, carbon content 14 %

Recommended application

- PAHs from water

PAHs from water

MN Appl. No. 301250

Column type:

CHROMABOND® C₁₈ PAH, 6 mL, 2 g

REF 730166

Sample pretreatment: mix 1000 mL water sample with 10 mL methanol

Column conditioning: 1 column volume methanol, then 1 column volume dist. water

Sample application: aspirate 1000 mL water sample through the column (~ 15–20 mL/min), then dry column (stream of nitrogen or 24 h in a desiccator over P₂O₅)

Elution: elute with 4 mL acetonitrile – benzene (3:1, v/v) and then evaporate or fill up to the volume required

Recovery rates (50 ng/L per component): naphthalene 87 %, acenaphthylene 89 %, acenaphthene 90 %, fluorene 82 %, phenanthrene 85 %, anthracene 90 %, fluoranthene 89 %, pyrene 89 %, benz[a]anthracene 87 %, chrysene 95 %, benzo[b]fluoranthene 91 %, benzo[k]fluoranthene 89 %, benzo[a]pyrene 90 %, dibenz[a,h]anthracene 97 %, benzo[ghi]perylene 91 %, indeno[1,2,3-cd]pyrene 96 %

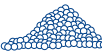
	Volume	Adsorbent weight → 2 g	Pack of
		CHROMABOND® C ₁₈ PAH polypropylene columns 6 mL	730166
	CHROMABOND® C ₁₈ PAH glass columns 6 mL	730166G	30
	CHROMABOND® C ₁₈ PAH adsorbent	730616	100 g



CHROMABOND® NH₂/C₁₈ combination phase for PAH analysis

★ Key features

- Special combination phase:
Aminopropyl phase for removal of interfering humic acids
octadecyl phase for the enrichment of PAHs

✓ Recommended application

- PAHs from water containing humic acids

	Volume	Adsorbent weight → 500/500 mg	500 mg / 1 g	Pack of
	CHROMABOND® NH ₂ /C ₁₈ polypropylene columns			
	6 mL	730618	730620	30

CHROMABOND® CN/SiOH combination phase for PAH analysis

★ Key features

- Cyanopropyl phase for selective adsorption of polycyclic aromatics via π-π interactions
- Unmodified silica phase for removal of polar compounds

✓ Recommended application

- Extraction of the 16 PAHs according to EPA from soil samples

	PAHs from soil MN Appl. No. 301310
<p>Column type: CHROMABOND® CN/SiOH, 6 mL, 500/1000 mg REF 730135</p> <p>Sample pretreatment: dry 30 g soil with sodium sulfate and reflux 4 h with 250 mL petroleum ether in a Soxhlet extractor. For low PAH contents (colorless or weakly colored extracts) concentrate extract to 1/10 of its volume in a rotation evaporator.</p> <p>Column conditioning: 4 mL petroleum ether</p>	<p>Sample application: aspirate 20 mL of the extract through the column</p> <p>Column washing: 2 mL petroleum ether</p> <p>Elution: 2 x 2 mL acetonitrile – toluene (3:1, v/v), then evaporate or fill to the volume required</p> <p>Further analysis: HPLC, e.g., with column 100 x 4 mm NUCLEODUR® C₁₈ PAH, 3 μm, REF 760783.40 according to application 123820 (see page 227)</p> <p>For recovery rates see application 301310 at www.mn-net.com/apps</p>

	Volume	Adsorbent weight → 500 mg / 1 g	Pack of
	CHROMABOND® CN/SiOH polypropylene columns		
	6 mL	730135	30
	CHROMABOND® CN/SiOH glass columns		
	6 mL	730135.250	250
CHROMABOND® CN/SiOH glass columns · BIGpack			
6 mL	730135G	30	

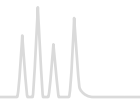

CHROMABOND® Na₂SO₄/Florisol® hydrocarbons from water in accordance with DIN H-53 / ISO DIS 9377-4

★ Key features

- Special combination phase of sodium sulfate and Florisol®

✓ Recommended application

- Hydrocarbons from drinking, surface and waste waters

Hydrocarbons from water

MN Appl. No. 302090

 **Column type:**
CHROMABOND® Na₂SO₄/Florisol®, 6 mL, 2 g/2 g glass column
REF 730249G

Internal standard solution: dissolve 20 mg *n*-tetracontane (C₄₀H₈₂) in petroleum ether, add 20 mL *n*-decane (C₁₀H₂₂) and fill up to one liter with petroleum ether. For the preparation of the extraction solution dilute standard solution 1:10 with petroleum ether.

Sample pretreatment: adjust 900 mL water (10 °C) with HCl (12 mol/L) to pH 2 and add 80 g MgSO₄. Add 50 mL of the extraction solution, close the bottle and stir the suspension intensely for 30 min. Add enough dist. water to separate the organic from the aqueous phase.

Column conditioning: 5 mL petroleum ether

Sample application: slowly aspirate or force the sample through the column

Elution: wash with 10 mL petroleum ether. Evaporate the combined solution from sample application and elution to 1 mL at about 75 °C. If necessary, fill up to 1 mL again. (If the hydrocarbon content is high, evaporation to 1 mL may not be necessary.)

Recovery rates: must be > 80 % for *n*-tetracontane

	Volume	Adsorbent weight → 2 g / 2 g	Pack of
	CHROMABOND® Na ₂ SO ₄ /Florisol® polypropylene columns		
	6 mL	730249	30
	CHROMABOND® Na ₂ SO ₄ /Florisol® glass columns		
	6 mL	730249G	30
CHROMABOND® Na ₂ SO ₄ /Florisol® glass columns · BIGpack			
6 mL	730249G.250	250	





CHROMABOND® NAN special phase for PCB analysis

★ Key features

- N: sodium sulfate for removal of trace water
- A: SiOH/AgNO₃ phase for removal of sulfur, sulfur-containing and polar compounds

✓ Recommended application

- Extraction of PCBs from sludge

PCB from sludge MN Appl. No. 301400	
<p>Compounds investigated: polychlorinated biphenyls (PCB) This method can also be used for soil samples.</p> <p>Column type: CHROMABOND® NAN, 6 mL, 700/2000/700 mg REF 730149</p> <p>Sample pretreatment: extract 2 g lyophilized sludge with 70 mL <i>n</i>-hexane, evaporate extract and fill to 10 mL with <i>n</i>-hexane</p>	<p>Column conditioning: 10 mL <i>n</i>-hexane</p> <p>Sample application: aspirate 2 mL extract into the column</p> <p>Elution: slowly aspirate 40 mL <i>n</i>-hexane through the column with light vacuum, then evaporate and fill to 5 mL with <i>n</i>-hexane</p> <p>Recovery rates: PCB-28 104 %, PCB-52 100 %, PCB-101 99 %, PCB-138 98 %, PCB-153 101 %, PCB-180 98 %, PCB-209 104 %</p>

	Volume	Adsorbent weight → 400/1400/400 mg	700/2000/700 mg	Pack of
	CHROMABOND® NAN polypropylene columns			
	3 mL	730109		50
	6 mL		730149	30
	CHROMABOND® NAN polypropylene columns · BIGpack			
	6 mL		730149.250	250
	CHROMABOND® NAN glass columns			
	6 mL		730149G	30
	CHROMABOND® NAN adsorbent*			
		730619		100 g

* This product contains harmful substances which must be specially labeled as hazardous. For detailed information please see SDS.

For further applications on CHROMABOND® phases visit our online application database at <https://chromaappdb.mn-net.com/>

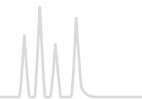

CHROMABOND® SA/SiOH combination phase for PCB analysis

★ Key features

- SA: strongly acidic cation exchanger based on silica with benzenesulfonic acid modification
- SiOH: unmodified silica for removal of polar compounds

✓ Recommended application

- Extraction of PCBs from waste oil (hexane extract)

PCB from waste oil MN Appl. No. 301390

 **Column type:**
CHROMABOND® SA/SiOH, 3 mL, 500/500 mg
REF 730132

Column conditioning: 1 mL *n*-hexane

Sample application: apply 250 µL waste oil sample to the column and aspirate or force it into the adsorbent with 2 x 1 mL *n*-hexane

Elution: aspirate or force another 2 x 500 µL *n*-hexane through the column; collect all *n*-hexane fractions and if necessary adjust concentration for subsequent analysis by either evaporating *n*-hexane in a stream of nitrogen or by dilution with *n*-hexane

Recovery rates: PCB-28 97 %, PCB-52 96 %, PCB-101 95 %, PCB-138 90 %, PCB-153 95 %, PCB-180 96 %, PCB-209 100 %

	Volume	Adsorbent weight →500/500 mg	Pack of
	CHROMABOND® SA/SiOH polypropylene columns		
	3 mL	730132	50
	CHROMABOND® SA/SiOH polypropylene columns · BIGpack		
	3 mL	730132.250	250

For further applications on CHROMABOND® phases visit our online application database at <https://chromaappdb.mn-net.com/>

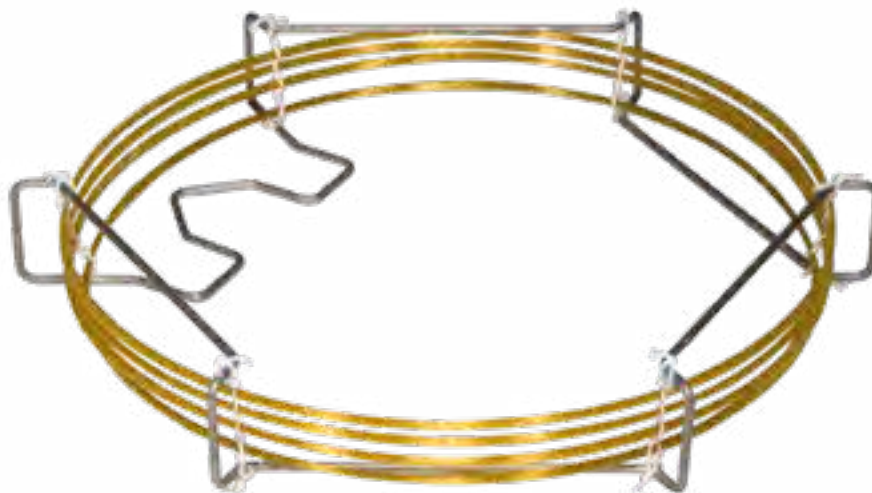

PCBs can be separated successfully with e.g., OPTIMA® XLB (see page 325).



CHROMABOND® SiOH-H₂SO₄/SA combination phase for PCB analysis

★ Key features

- SiOH-H₂SO₄: H₂SO₄-impregnated silica phase for oxidation of accompanying compounds to ionic and / or polar compounds
- SA: strongly acidic cation exchanger based on silica with benzenesulfonic acid modification for removal of ionic and sulfur-containing compounds
- This combination column is used together with a SiOH column. Both columns together are available as Kombi-Kit PCB.

✓ Recommended application

- Extraction of PCBs from oil with reference to German industrial standard DIN 51527, part 1

PCB in oil samples

MN Appl. No. 301380

determination with reference to German industrial standard DIN 51527

Column type:

CHROMABOND® SiOH-H₂SO₄/SA, 3 mL, 500/500 mg and

CHROMABOND® SiOH, 3 mL, 500 mg

REF 730085 and 730073

or Kombi-Kit PCB, REF 730125

Sample pretreatment: extract oil-contaminated solids with *n*-hexane. Homogenize other oil samples and dissolve 1.5 to 2.0 g in 50 mL *n*-hexane. Water which may cause turbidity can be removed with sodium sulfate.

Column conditioning: let 1 mL *n*-hexane flow through the CHROMABOND® SiOH-H₂SO₄/SA column

Sample application: aspirate or force 500 µL sample through the CHROMABOND® SiOH-H₂SO₄/SA column. This phase offers better removal of interfering substances due to sulfonation. Place CHROMABOND® SiOH-H₂SO₄/SA column on top of the SiOH column with the aid of an adapter and after at least 30 s flush sample into the SiOH column with 2 x 1 mL *n*-hexane.

Elution: elute SiOH column with 3 x 0.5 mL *n*-hexane; adjust to a suitable concentration for subsequent GC analysis by evaporation of *n*-hexane in a stream of nitrogen or by dilution with *n*-hexane

Recovery rates: PCB-28 99 %, PCB-52 95 %, PCB-101 99 %, PCB-138 94 %, PCB-153 99 %, PCB-180 96 %, PCB-209 101 %

	Volume	Adsorbent weight → 500/500 mg	Pack of
	CHROMABOND® SiOH-H ₂ SO ₄ /SA polypropylene columns		
	3 mL	730085	50
	CHROMABOND® SiOH-H ₂ SO ₄ /SA polypropylene columns · BIGpack		
	3 mL	730085.250	250
Kombi-Kit for extraction of PCB from oil with reference to DIN 51527, part 1			
	25 columns each of CHROMABOND® SiOH-H ₂ SO ₄ /SA and CHROMABOND® SiOH	730125	1

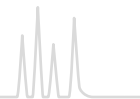

CHROMABOND® QuEChERS special silica phase for determination of pesticides in food samples

★ Key features

- Reliable CHROMABOND® adsorbents
- Different packaging with mixes for all established methods
- Convenient to use pre-weighed and mixed
- Saves time and money
- Increases efficiency in the laboratory
- Individual combination of mixes on request

✓ Recommended application

- Special SPE phase for quick and cheap determination of pesticides in strongly matrix-contaminated samples by GC or HPLC
- Other applications: veterinary drugs, mycotoxins, PFAS
- QuEChERS methode = Quick Easy Cheap Effective Rugged Safe

CHROMABOND® Diamino special silica phase for determination of pesticides in food samples

★ Key features

- Base material silica, pore size 60 Å
- Removes polar compounds (e.g., organic acids, pigments, sugars) from matrices like fruit or vegetables

Similar phases

- Supelclean™ PSA, Bond Elut® PSA

🔧 Technical characteristics

- Particle size 45 µm, specific surface 500 m²/g, pH stability 2–8
- Primary and Secondary Amine functions (PSA), 5 % C

Food analysis

QuEChERS methods and ready-mixes

Within a few years after its development by Anastassiades et al. [1] the QuEChERS method has gained a leading position for determination of pesticide residues in food samples by GC-MS or LC-MS, allowing rapid and cheap clean-up of strongly matrix-contaminated samples.

Advantages of QuEChERS in comparison with classical clean-up methods:

- High through-put, due to easy handling and time-saving procedure
- Low consumption of solvents
- No need for chlorinated solvents
- Suitable for a variety of pesticides
- Rugged method with high and safe recovery rates
- Broad applications for various foods

To optimize the extraction of pH-dependent compounds, to minimize decomposition of sensitive substances, and to broaden the matrix spectrum, different modifications of the QuEChERS method have been elaborated. These mixes differ in the type of buffer agent used and in this way the resulting pH value of the aqueous sample during the extraction vary.

Today three methods are used:

- Original (non-buffered) [1]
- AOAC Standard 2007.1 (acetate buffered) [2]
- EN 15662 (citrate buffered) [3]

In particular the buffered versions are commonly used.

All methods require two proceeding steps:

- Extraction: pesticides are transferred from the aqueous to the organic layer (often acetonitrile)
- Clean-up: Interfering substances (like e.g., lipids, pigments), which were also extracted with the organic layer, are removed by special adsorbents

Analysis: Sample is analyzed by GC-MS or LC-MS/MS

The QuEChERS procedure is described in the following in accordance with EN 15662:2008. An extraction mix and a clean-up mix is required.

Step 1 – Extraction and salting-out

1. Homogenize sample (e.g., with dry ice in a blender)
2. Weigh 10 g of the sample into a centrifuge tube
3. Add 10 mL of acetonitrile and internal standard
4. Shake vigorously for 1 minute
5. Add extraction mix to centrifuge tube
Optional: check pH and adjust pH to 5.0–5.5 with 5 mol/L aqueous NaOH.
6. Shake vigorously for 1 minute
7. Centrifuge for 5 minutes at > 3000 g. For the determination of pesticides with acidic groups, the raw extract should be analyzed directly (preferably by LC/MS ESI neg.)



Step 2 – Clean-up

1. Transfer an aliquot of the supernatant to a centrifuge tube containing a clean-up mix
2. Shake for 30 seconds
3. Centrifuge for 5 minutes at > 3000 g

Analysis

Transfer supernatant to vial, acidify with 5 % formic acid in acetonitrile (10 µL/mL extract) and analyze the sample by LC-MS or GC-MS. MACHEREY-NAGEL offers a variety of pre-weighed and mixed extraction and clean-up mixes, which are in accor-

dance with the above mentioned standardized methods, specially adapted to the different sample matrices. These matrices differ in their characteristics e.g., low or high fat content or different amounts of pigments.

If you require an individual mix, which differs in the composition from the below mentioned mixes, please contact us.

Additional MACHEREY-NAGEL offers the reliable adsorbent CHROMABOND® Diamino (PSA) as bulk material.

The following table provides guidance for the choice of different QuEChERS mixes:

Step 1 – Extraction and salting-out

Method	Sample weight	Solvent	Content of mix	Mix
EN 15662:2008, citrate-buffered [2]	10 g	10 mL acetonitrile	4 g MgSO ₄ , 1 g NaCl, 0.5 g Na ₂ H citrat · 1.5 H ₂ O, 1 g Na ₃ citrat · 2 H ₂ O	Mix I
AOAC 2007.01, acetate-buffered [3]	15 g	15 mL 1 % acetic acid in acetonitrile	6 g MgSO ₄ , 1.5 g NaOAc	Mix II
Original non-buffered [1]	10 g	10 mL acetonitrile	4 g MgSO ₄ , 1 g NaCl	Mix XII

Step 2 – Clean-up

Sample property	Content of mix	EN 15662	AOAC 2007.01
Low fat content e.g., apple, asparagus, broccoli, pear, pineapple, strawberry	MgSO ₄ Diamino (PSA)	Mix III	Mix XX
Moderate content of chlorophyll and carotenoids e.g., carrot, lettuce	MgSO ₄ Diamino (PSA) Carbon	Mix IV	Mix XVII
Higher content of chlorophyll and carotenoids e.g., pepper, spinach, blackberry, raspberry	MgSO ₄ Diamino (PSA) Carbon	Mix V	–
Higher fat content e.g., avocado, cereals, nuts, beef, chicken, pork, dairy products, soil, oils, baby food	MgSO ₄ Diamino (PSA) C ₁₈ ec	Mix VI	Mix XIX

Adsorbents and what they are used for

- MgSO₄ removes excess of water
- NaCl for phase separation
- CHROMABOND® Diamino (PSA) (Primary Secondary Amine) removes organic and fatty acids, sugars and anthocyanin pigments
- CHROMABOND® C₁₈ ec (reversed phase modified silica) traps nonpolar compounds, e.g., lipids
- CHROMABOND® Carbon (GCB) (Graphitized Carbon Black) removes pigments and sterols (please note: planar pesticides are also removed)

Further information can be found online at www.mn-net.com/QuEChERS or www.QuEChERS.com

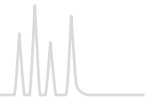

Volume	Adsorbent weight → 200 mg	Pack of
	CHROMABOND® Diamino adsorbent	
	730653.20	20 g
	730653	100 g



Extraction mixes

Method	Mix No.	Content of mix	Volume	Quantity	REF
In aluminum packets (Sticks)					
EN 15662	Mix I	4000 mg MgSO ₄ , 1000 mg NaCl, 500 mg Na ₂ H citrate x 1.5 H ₂ O, 1000 mg Na ₃ citrate x 2 H ₂ O	Individually weighed in aluminum packets (Sticks)	50	730970.3
EN 15662	Mix I	4000 mg MgSO ₄ , 1000 mg NaCl, 500 mg Na ₂ H citrate x 1.5 H ₂ O, 1000 mg Na ₃ citrate x 2 H ₂ O	Individually weighed in aluminum packet (Sticks), including 50 mL empty centrifuge tubes	50	730970.3T
AOAC 2007.01	Mix II	6000 mg MgSO ₄ , 1500 mg NaOAc	Individually weighed aluminum packets (Sticks), including 50 mL empty centrifuge tubes	50	730971.3T
AOAC 2007.01	Mix II	6000 mg MgSO ₄ , 1500 mg NaOAc	Individually weighed in aluminum packets (Sticks)	50	730971.3
Original	Mix XII	4000 mg MgSO ₄ , 1000 mg NaCl	Individually weighed in aluminum packets (Sticks)	50	730648.3
Original	Mix XII	4000 mg MgSO ₄ , 1000 mg NaCl	Individually weighed aluminum packets (Sticks), including 50 mL empty centrifuge tubes	50	730648.3T
Original	Mix XII	6000 mg MgSO ₄ , 1500 mg NaCl	Individually weighed in aluminum packets (Sticks)	50	730989.3
Original	Mix XII	6000 mg MgSO ₄ , 1500 mg NaCl	Individually weighed aluminum packets (Sticks), including 50 mL empty centrifuge tubes	50	730989.3T
15 mL centrifuge tube (PP) with screw cap (PE)					
EN 15662	Mix I	4000 mg MgSO ₄ , 1000 mg NaCl, 500 mg Na ₂ H citrate x 1.5 H ₂ O, 1000 mg Na ₃ citrate x H ₂ O	15 mL	50	730970
EN 15662	Mix I	4000 mg MgSO ₄ , 1000 mg NaCl, 500 mg Na ₂ H citrate x 1.5 H ₂ O, 1000 mg Na ₃ citrate x 2 H ₂ O	15 mL	100	730970.100
EN 15662	Mix I	8000 mg MgSO ₄ , 2000 mg NaCl, 1000 mg Na ₂ H citrate x 1.5 H ₂ O, 2000 mg Na ₃ citrate x 2 H ₂ O	15 mL	100	730436.100
AOAC 2007.01	Mix II	1200 mg MgSO ₄ , 300 mg NaOAc	15 mL	50	730964
AOAC 2007.01	Mix II	6000 mg MgSO ₄ , 1500 mg NaOAc	15 mL	50	730971
Original	Mix XII	4000 mg MgSO ₄ , 1000 mg NaCl	15 mL	50	730648
Original	Mix XII	1000 mg MgSO ₄ , 250 mg NaCl	15 mL	50	730984
50 mL centrifuge tube (PP) with screw cap (PE)					
EN 15662	Mix I	4000 mg MgSO ₄ , 1000 mg NaCl, 500 mg Na ₂ H citrate x 1.5 H ₂ O, 1000 mg Na ₃ citrate x 2 H ₂ O	50 mL	50	730970.1
AOAC 2007.01	Mix II	4000 mg MgSO ₄ , 1000 mg NaOAc	50 mL	50	730694.1
Original	Mix XII	4000 mg MgSO ₄ , 1000 mg NaCl	50 mL	50	730648.1

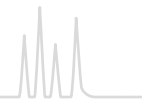

Clean-up mixes

Method	Mix No.	Content of mix	Volume	Quantity	REF
2 mL centrifuge tube (PP) with snap cap					
EN 15662	Mix III	150 mg MgSO ₄ , 25 mg CHROMABOND® Diamino	2 mL	50	730646.2
EN 15662	Mix IV	150 mg MgSO ₄ , 25 mg CHROMABOND® Diamino, 2.5 mg CHROMABOND® Carbon	2 mL	50	730850.2
EN 15662	Mix V	150 mg MgSO ₄ , 25 mg CHROMABOND® Diamino, 7.5 mg CHROMABOND® Carbon	2 mL	50	730358.2
EN 15662	Mix VI	150 mg MgSO ₄ , 25 mg CHROMABOND® Diamino, 25 mg CHROMABOND® C ₁₈ ec	2 mL	50	730858.2
EN 15662	Mix XI	150 mg MgSO ₄ , 50 mg CHROMABOND® C ₁₈ ec	2 mL	50	730983.2
EN 15662	Mix XV	150 mg MgSO ₄ , 100 mg CHROMABOND® C ₁₈ ec	2 mL	50	730987.2
AOAC 2007.01	Mix XVII	150 mg MgSO ₄ , 50 mg CHROMABOND® Diamino, 50 mg CHROMABOND® Carbon	2 mL	50	730996.2
AOAC 2007.01	Mix XIX	150 mg MgSO ₄ , 50 mg CHROMABOND® Diamino, 50 mg CHROMABOND® C ₁₈ ec	2 mL	50	730657.2
AOAC 2007.01, EN 15662	Mix XX	150 mg MgSO ₄ , 50 mg CHROMABOND® Diamino	2 mL	50	730670.2
AOAC 2007.01	Mix XLVII	150 mg MgSO ₄ , 50 mg CHROMABOND® Diamino, 50 mg CHROMABOND® Carbon, 50 mg CHROMABOND® C ₁₈ ec	2 mL	50	730843.2
15 mL centrifuge tube (PP) with screw cap (PE)					
EN 15662	Mix III	600 mg MgSO ₄ , 100 mg CHROMABOND® Diamino	15 mL	50	730980
EN 15662	Mix III	900 mg MgSO ₄ , 150 mg CHROMABOND® Diamino	15 mL	50	730972
EN 15662	Mix III	900 mg MgSO ₄ , 150 mg CHROMABOND® Diamino	15 mL	100	730972.100
EN 15662	Mix III	450 mg MgSO ₄ , 75 mg CHROMABOND® Diamino	15 mL	50	730992
EN 15662	Mix III	1200 mg MgSO ₄ , 200 mg CHROMABOND® Diamino	15 mL	100	730650.100
EN 15662	Mix IV	900 mg MgSO ₄ , 150 mg CHROMABOND® Diamino, 15 mg CHROMABOND® Carbon	15 mL	50	730973
EN 15662	Mix V	900 mg MgSO ₄ , 150 mg CHROMABOND® Diamino, 45 mg CHROMABOND® Carbon	15 mL	50	730975
EN 15662	Mix V	900 mg MgSO ₄ , 150 mg CHROMABOND® Diamino, 45 mg CHROMABOND® Carbon	15 mL	100	730975.100
EN 15662	Mix VI	450 mg MgSO ₄ , 75 mg CHROMABOND® Diamino, 75 mg CHROMABOND® C ₁₈ ec	15 mL	50	730155
EN 15662	Mix VI	900 mg MgSO ₄ , 150 mg CHROMABOND® Diamino, 150 mg CHROMABOND® C ₁₈ ec	15 mL	50	730974
EN 15662	Mix VI	900 mg MgSO ₄ , 150 mg CHROMABOND® Diamino, 150 mg CHROMABOND® C ₁₈ ec	15 mL	100	730974.100
AOAC 2007.01	Mix XVII	1200 mg MgSO ₄ , 400 mg CHROMABOND® Diamino, 400 mg CHROMABOND® Carbon	15 mL	50	730842
AOAC 2007.01	Mix XIX	0.15 g MgSO ₄ , 50 mg CHROMABOND® Diamino, 50 mg CHROMABOND® C ₁₈ ec	15 mL	50	730657
AOAC 2007.01	Mix XX	1.20 g MgSO ₄ , 0.40 g CHROMABOND® Diamino	15 mL	50	730658
	Mix LII	CHROMABOND® QuEChERS Diamino C ₁₈ ec Clean-up-Mix, 900 mg Na ₂ SO ₄ , 50 mg CHROMABOND® Diamino, 150 mg CHROMABOND® C ₁₈ ec	15 mL	50	7300019
	Mix LIII	CHROMABOND® QuEChERS Extraction mix, 4000 mg Na ₂ SO ₄ , 1000 mg NaCl	15 mL	50	7300020
	Mix LIV	CHROMABOND® C ₁₈ ec Clean-up-Mix, 900 mg Na ₂ SO ₄ , 200 mg CHROMABOND® C ₁₈ ec	15 mL	50	7300021
	Mix LV	CHROMABOND® QuEChERS extraction mix, 4000 mg Na ₂ SO ₄ , 1000 mg NaCl, 500 mg, 500 mg Na ₂ H citrate x 1.5 H ₂ O, 1000 mg Na ₃ citrate x 2 H ₂ O	15 mL	50	7300022

Further information can be found online at www.mn-net.com/QuEChERS or www.QuEChERS.com

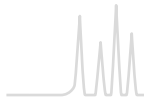

CHROMABOND® ABC18 special phase for analysis of acrylamide in food

★ Key features

- Octadecyl silica phase with ion exchange functions for acrylamide analysis

✓ Recommended application

- Clean-up of acrylamide from ultra-heated starch-containing food, such as potato chips and other snacks, french fries, crispbread, cereals etc.

	Volume	Adsorbent weight → 500 mg	Pack of
	CHROMABOND® ABC18 polypropylene columns 6 mL	730533	30

Important notes

- For “Determination of Acrylamide in Foods, SPE Clean-up Procedure for LC-MS/MS” please see application 303580 at <https://chromaappdb.mn-net.com/>
- Acrylamide is created at temperatures above 100 °C from sugar and proteins, e.g., from potatoes or grain during the process of frying, baking, roasting or grilling. The formation depends on temperature, starting at 120 °C and increasing with more elevated temperatures. In cooked food, no acrylamide is found.
- Minimum concentration of acrylamide should be 70 µg/kg.
- The procedure includes no concentration step.
- Acrylamide and the isotopically labeled form, is carcinogenic, mutagenic and neurotoxic.

CHROMABOND® Carbon A

🔧 Technical characteristics

- Base material activated carbon, highly porous, spherical particles, specific surface > 1000 m²/g

✓ Recommended application

- Acrylamide from water according to DIN 38413-6 (e.g., application 306140)

Enrichment of acrylamide from water acc. to DIN 38413

MN Appl. No. 306140

Column type:

CHROMABOND® Carbon A, 6 mL, 1000 mg
REF 730167

Sample pretreatment: A drinking water sample was taken according to DIN 38402. The sample was treated with 100 mg/L sodium thiosulfate pentahydrate to reduce oxidizing species. 40 mg/L sodium azide was then added to avoid microbiological degradation. An aliquot of 500 mL pretreated water sample was spiked with 50 ng acrylamide.

Column conditioning: 8 mL methanol and 8 mL water

Sample application: sample was aspirated at a flow of 20 mL/min

Column washing: 1 mL water

Drying: 15 min nitrogen or air flow

Elution: 5 x 2 mL methanol

Concentration: eluate was concentrated to 1 mL by heating at 40 °C under a slight nitrogen stream

Recovery rates: 81 % (SD: 5 % [n=6])

Further analysis: HPLC-MS/MS in reference to appl. no. 127530

	Volume	Adsorbent weight → 500 mg	1 g	2 g	Pack of
	CHROMABOND® Carbon A polypropylene columns 6 mL	730165	730167	730156	30

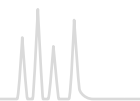

CHROMABOND® Dry (Na_2SO_4) special phase for drying of organic samples

★ Key features

- Anhydrous high-purity sodium sulfate which forms Glauber's salt with traces of water

☑ Recommended application

- Removal of traces of water from organic solutions.
- For removal of larger quantities of water several cartridges can be combined in series.

	Size →	S	M	L	Pack of
	Minimum adsorbent weight →	360 mg	760 mg	2000 mg	
	CHROMAFIX® Dry cartridges	731852	731853	731854	50

For further applications on CHROMABOND® phases visit our online application database at <https://chromaappdb.mn-net.com/>





CHROMABOND® PTS and PTL PTS and PTL columns for phase separation

★ Key features

- Automatic separation of a two-phase mixture without separation funnel
- Two-phase mixtures are completely applied to the column and the phase boundary is determined without further work. The special membrane automatically stops the flow when the lower phase has passed. The upper phase remains in the column, thus both phases are available for further analysis.
- Columns must not be run with vacuum or pressure

✓ Recommended application

- PTS: for solvents heavier than water, e.g., trichloromethane, dichloromethane maximum size 150 mL
- PTL: for solvents lighter than water, e.g., diethyl ether, hexane maximum size 70 mL

Column volume	Pack of [columns]	REF
CHROMABOND® PTS for solvents heavier than water		
3 mL	100	730712
6 mL	100	730714
15 mL	100	730716
30 mL	100	730718
45 mL	50	730720
70 mL	50	730722
150 mL	20	730724
CHROMABOND® PTL for solvents lighter than water		
3 mL	100	730732
6 mL	100	730734
15 mL	100	730736
30 mL	100	730738
45 mL	50	730740
70 mL	50	730742

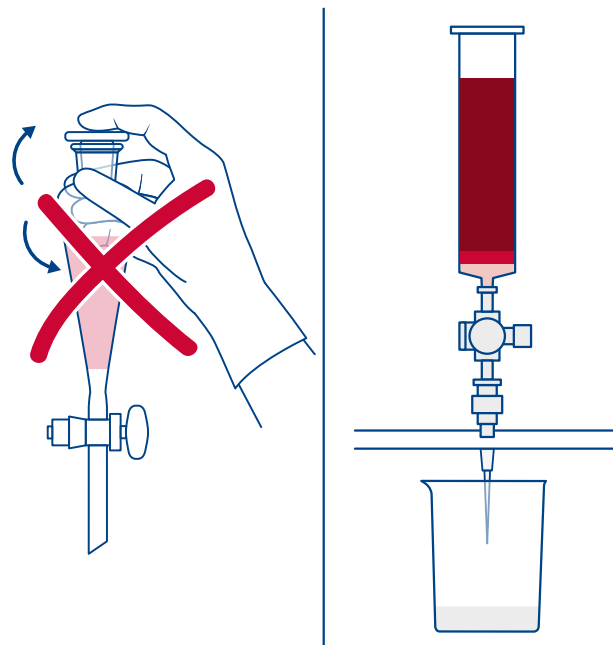

Ideal tool for breaking emulsions

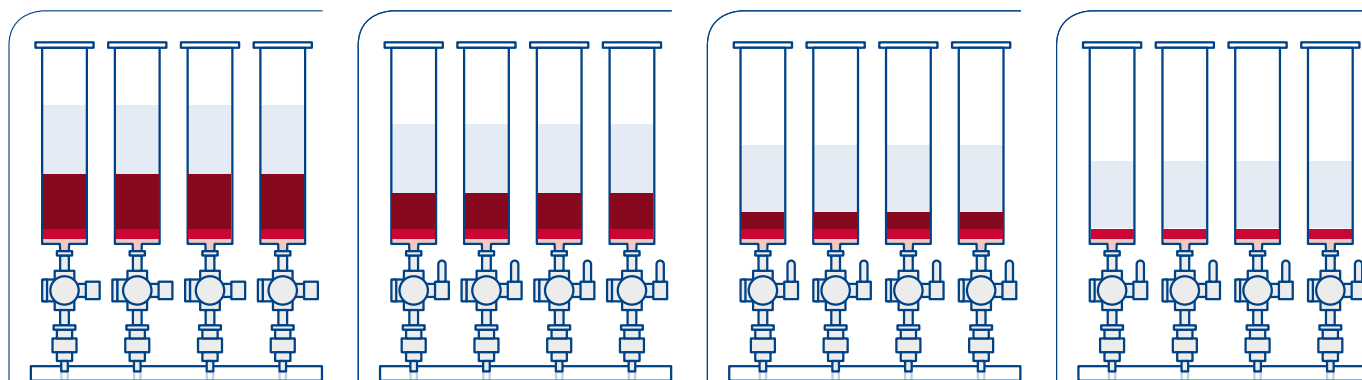

CHROMABOND® PTL in action: organic upper phase (colorless), aqueous lower phase (red)

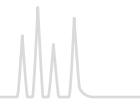

CHROMABOND® XTR for liquid-liquid extraction

★ Key features

- Base material coarse-grained kieselguhr (also known as diatomaceous earth, hydromatrix, celite), large pore size, high pore volume, constantly high batch-to-batch quality, pH working range 1 – 13
- Advantages:
 - Fast, reproducible and economical
 - Simultaneous preparation of several samples
No problems with phase separation
 - No formation of emulsions
 - High recovery rates
 - Saving of time and solvents
 - Organic solutions need not to be dried after separation

Solvents applicable for elution

- Diethyl ether
- *tert* butyl methyl ether
- Ethyl acetate
- *n*-hexane
- Cyclohexane
- Toluene
- Dichloromethane (methylene chloride)
- Trichloromethane (chloroform)
- Trichloromethane – methanol (90:10, v/v)
- Trichloromethane – methanol (85:15, v/v)
- Diethyl ether – ethanol (90:10, v/v)
- Diethyl ether – ethanol (80:20, v/v)
- Dichloromethane – 2-propanol (90:10, v/v)
- Dichloromethane – 2-propanol (85:15, v/v)

Eluents with too high alcohol contents cause an increase in volume of the aqueous phase on the CHROMABOND® XTR. Here the column could be overloaded and the aqueous phase displaced from the column. In this case, a greater capacity column should be used.

Depending on the concentration of the analytes eluates can be analyzed immediately, or the organic solvent is evaporated. The pH value of the aqueous solution can be altered on the column, which enables elution of different compounds of a sample under optimized conditions. Under certain circumstances, acidic, neutral, and basic compounds can be fractionated in this way.

✓ Recommended application

- Liquid-liquid extraction of highly viscous aqueous solutions such as physiological fluids (blood, plasma, and serum) in clinical chemistry, dyes in textiles, environmental and food analysis without use of a separation funnel
- High water loadability without breakthrough of water during elution with organic solvents also suited for removing small amounts of water from solvents which are not miscible with water

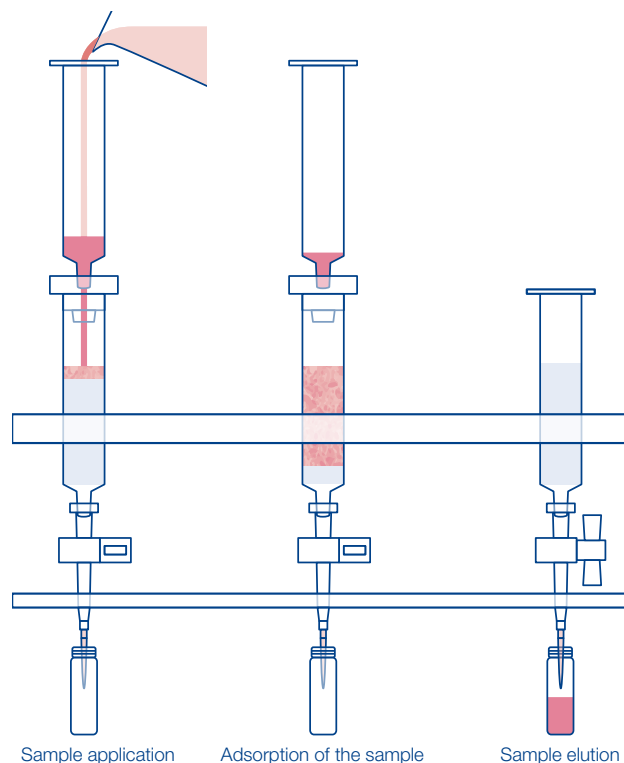

Volume	Adsorbent weight	Max. volume capacity of aq. solution	Waiting period before elution	Elution volume
CHROMABOND® XTR				
3 mL	500 mg	0.5 mL	5 min	6 mL
6 mL	1 g	1 mL	5 – 10 min	8 mL
15 mL	3 g	3 mL	5 – 10 min	12 mL
30 mL	4.5 g	5 mL	5 – 10 min	16 mL
45 mL	8.3 g	10 mL	10 – 15 min	24 mL
70 mL	14.5 g	20 mL	10 – 15 min	40 mL
150 mL	37.5 g	50 mL	10 – 15 min	90 mL



Determination of azo dyes and aromatic amines in colored textile materials
with reference to § 64 LFGB (formerly § 35 LMBG)

MN Appl. No. 302100

Column type:

CHROMABOND® XTR, 70 mL, 14.5 g, for max. 20 mL aqueous solution
REF 730507

Sample pretreatment: Weigh about 1 g cut-up textile sample (colored textiles about 0.1 g) in a 100 mL threaded vial. (Degrease leather samples before processing: cover sample with technical purity *n*-hexane and put the vial in an ultrasonic bath for 20 min. After decanting the *n*-hexane rinse with little *n*-hexane and dry sample by gentle heating and blowing with air or N₂).

Add 250 µL internal standard (IS: 1.2 mg/mL tetramethylbenzidine in methanol – ethyl acetate (1:1, v/v)), 17.0 mL citrate buffer (pH 6) (25.05 g citric acid and 12.64 g NaOH, fill up with deionized water to 2 L) and heat 30 min at 70 °C.

Then add 3 mL of a freshly prepared solution of 0.2 g/mL sodium dithionite in water and heat for exactly 30 min to 70 °C while shaking occasionally.

Sample application: Cool the solution immediately (put vial in water – stopping of reductive cleavage). After 5 – 10 min pour it onto the CHROMABOND® XTR column (squeeze textile remains).

Elution: Allow solution to be soaked up by the adsorbent for 15 min. Then elute four times with 20 mL each of diethyl ether or diethyl ether – ethanol (90:10, v/v) (depending on recovery rates), using the first 40 mL to rinse the sample remains.

Evaporate eluates to 3 mL with a rotation evaporator and transfer the solution into a 10 mL measuring flask using a pasteur pipette and rinsing with methanol. Fill up to the marking with methanol, shake, and pipette about 1 mL into a vial.

Further analysis:

Fast GC on OPTIMA® δ-3, 10 m, 0.1 mm ID, 0.1 µm film, REF 726410.10 (application 210820) or HPLC on NUCLEOSIL® 100–5 C₁₈ HD (application 110500 at www.mn-net.com/apps)

Column volume	3 mL	6 mL	15 mL	30 mL	45 mL	70 mL	150 mL
Adsorbent weight	500 mg	1 g	3 g	4.5 g	8.3 g	14.5 g	37.5 g
Max. volume capacity of aqueous solution	0.5 mL	1 mL	3 mL	5 mL	10 mL	20 mL	50 mL
Pack of →	50	30	30	30	30	30	10

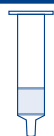

CHROMABOND® XTR polypropylene columns (glass columns on request)

730502 730487 730489 730505 730506 730507 730509

CHROMABOND® XTR polypropylene columns · BIGpacks

730487.250 (250 col.) 730507.100 (100 col.)

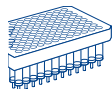

CHROMABOND® MULTI 96 XTR

96-well plates 96 × 150 mg, packs of 1 plate, for max. 96 × 0.2 mL aqueous solution

738131.150M



CHROMABOND® XTR adsorbent

50 bags of 14.5 g, (for max. 20 mL aqueous solution each)

for NT20 with 50 PE
filter elements (10 mm
dia.)

500 g 1 kg 5 kg

730586 730595.500 730595.1000 730595.5000

Accessories for liquid-liquid extraction with CHROMABOND® XTR

variable polypropylene rack for 24 positions, incl. 24 PP stopcocks and 24 PP needles

730508

For parallel processing of up to 24 CHROMABOND® XTR columns 1 – 150 mL we recommend the polypropylene rack REF 730508 consisting of: Two side walls, middle part including stopcocks and needles, bottom part, top part for stabilizing 45 mL and 70 mL CHROMABOND® XTR columns.

This rack can be adjusted to various heights depending on the CHROMABOND® XTR columns and the collection vials used.

Each position of the middle part is equipped with a polypropylene stopcock on the top (REF 730185N) and a polypropylene needle on the bottom (REF 730154N).

For collection of the sample, vessels such as vials, test tubes, round bottom or tapered flasks, can be used. For our program of sample vials, please see the chapter “Vials and accessories” from page 100.

For further applications on CHROMABOND® phases visit our online application database at <https://chromaappdb.mn-net.com/>

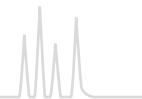

CHROMABOND® Vacuum manifold

★ Key features

- For the simultaneous preparation of up to 12 or 24 samples
- Replacement parts and accessories for special applications

Vacuum manifold for 12 columns

- ① Rectangular glass cabinet; 2 sizes available: small for up to 12 CHROMABOND® columns or CHROMAFIX® cartridges; large for up to 24 CHROMABOND® columns or CHROMAFIX® cartridges
- ② Polypropylene lid
- ③ Vacuum gauge for pressure reading
- ④ Control valve for adjustment of vacuum
- ⑤ Replaceable valves for vacuum control of individual SPE columns
- ⑥ Variable rack with exchangeable partitions, which accept a wide variety of vessels like test tubes, measuring flasks, scintillation vials, autosampler vials, plastic vials etc.
- ⑦ CHROMABOND® LV columns with 15 mL sample reservoir for medium size samples
- ⑧ Polypropylene sample reservoirs (30 or 70 mL)*
- ⑨ Adapter for sample reservoirs*
- ⑩ CHROMABOND® tubing adapters

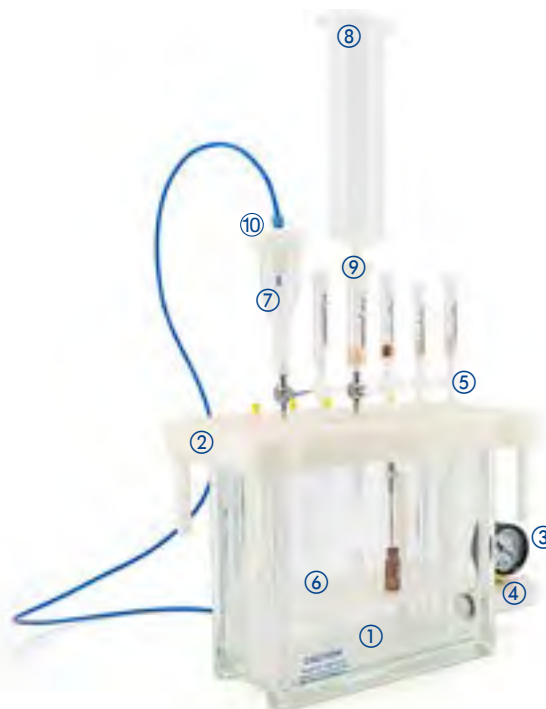

Full description and manual can be downloaded at www.mn-net.com

Description	Pack of	REF
Vacuum manifold complete		
consists of glass cabinet with lid and lid gasket, removable needles on lower side of lid, vacuum gauge, control valve, valves and caps, variable rack:		
for up to 12 columns or cartridges (including PP tank)	1	730150N
for up to 24 columns or cartridges (including PP tank)	1	730151N
Glass cabinets without accessories ①		
for 12 columns	1	730173N
for 24 columns (large)	1	730174N
Lids with gaskets ②		
for 12 columns (including Luer fittings and valves ⑤)	1	730175N
for 24 columns (including Luer fittings and valves ⑤)	1	730176N
Gaskets for lid, for 12 columns	2	730177N
Gaskets for lid, for 24 columns	2	730178N

* Ordering information see on page 68.



Description	Pack of	REF
General accessories for vacuum manifolds		
Luer stoppers for vacuum manifold, blue	12	730194
Luer fittings for lid, female	12	730183.12
Luer fittings for lid, male	12	730184.12
Valves, plastic ⑤	12	730185N
Stainless steel needles	12	730152
Polypropylene needles	12	730154N
PP tanks for vacuum manifold for 12 columns	2	730233N
PP tanks for vacuum manifold for 24 columns	2	730590N
Vacuum gauge, complete with accessories ③ + ④	1	730179
Feet for vacuum manifold lid	4	730193N
Drying attachment and collecting racks for evaporation of eluates (application see below)		
Drying attachment, with 12 positions ⑪	1	730187N
Drying attachment, with 24 positions	1	730188N
Collecting rack for 12 columns ⑥	1	730157N
Collecting rack for 24 columns	1	730153N
Products for protection from cross contamination		
Valve, brass, tarnished	1	730189.1
Valves, as above	12	730189.12
Stainless steel connectors	12	730106
PP connectors	12	730564N
Tubing adapters for application of large sample volumes ⑩		
for 3 and 6 mL glass columns	4	730387
for 1, 3 and 6 mL polypropylene columns	4	730243
for 15, 45 and 70 mL polypropylene columns (material: PTFE tube length approx. 1 m)	4	730386

Protection from cross contamination

For special applications which require maximum protection from cross contamination we supply chrome-plated brass valves and stainless steel or PP connectors. Their application is shown on the right side. These special connectors are fitted through the lid; thus the sample only has contact with the inert connector and can flow directly into the receptacle.

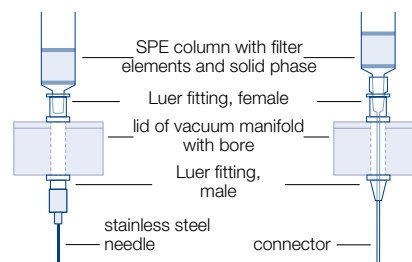

Drying attachment

If the eluate has to be evaporated, this can be performed with the so-called drying attachment ⑪. This special lid has a gas connector ⑫ on one side, from which the gas is fed simultaneously to the 12 or 24 stations ⑬. Thus 12 or 24 eluates can be evaporated simultaneously by just changing the lid and applying a stream of inert gas, e.g., nitrogen.





Empty columns and accessories

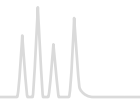

For individual packing of SPE columns with CHROMABOND® adsorbents

Description	Pack of	REF
Empty polypropylene columns with 2 PE filter elements, 1 mL	100	730159
Empty polypropylene columns with 2 PE filter elements, 3 mL	50	730160
Empty polypropylene columns with 2 PE filter elements, 6 mL	30	730161
Empty polypropylene columns with 2 PE filter elements, 15 mL	20	730230
Empty polypropylene columns with 2 PE filter elements, 30 mL	20	730380
Empty polypropylene columns with 2 PE filter elements, 45 mL	20	730355
Empty polypropylene columns with 2 PE filter elements, 70 mL	20	730158
Empty polypropylene columns with 2 PE filter elements, 150 mL	20	730474
PE filter elements for polypropylene columns 1 mL	250	730164
PE filter elements for polypropylene columns 3 mL	250	730162
PE filter elements for polypropylene columns 6 mL	250	730163
PE filter elements for polypropylene columns 15 mL	250	730351
PE filter elements for polypropylene columns 30 mL	250	730034
PE filter elements for polypropylene columns 45 mL	250	730356
PE filter elements for polypropylene columns 70 mL	250	730026
PE filter elements for polypropylene columns 150 mL	250	730475
Empty glass columns with 2 glass fiber filter elements, 3 mL	50	730171
Empty glass columns with 2 glass fiber filter elements, 6 mL	30	730172
Glass fiber filter elements for glass columns 3 mL	250	730191
Glass fiber filter elements for glass columns 6 mL	250	730192
Empty LV polypropylene columns with PE filter elements, 15 mL, for 200/500 mg adsorbent weight	50	732501
PE filter elements for LV polypropylene columns 15 mL for 200/500 mg adsorbent weight	250	732020
Adapters (PVDF) for glass columns	10	730105
Adapters for polypropylene columns (1, 3 and 6 mL)	10	730101
Adapters for polypropylene columns (15, 45, 70 mL)	10	730385
Adapter (PE) for polypropylene columns (30 and 70 mL)	1	730566
Reservoir columns for application of medium-size samples ⓘ + ⓘ		
10 Reservoir columns 30 mL, polypropylene, with one adapter for 1, 3, 6 mL CHROMABOND® polypropylene columns	1 kit	730103
10 Reservoir columns 70 mL, polypropylene, with one adapter for 1, 3, 6 mL CHROMABOND® polypropylene columns	1 kit	730382
10 Reservoir columns 70 mL, polypropylene, with one adapter for 15, 45, 70 mL CHROMABOND® polypropylene columns	1 kit	730389



Automated and on-line SPE

Performing Solid Phase Extraction (SPE) manually can be time consuming and nerve-racking, especially when recovery and reproducibility are lacking due to sample variability. If SPE can be reliably automated it becomes a much more efficient and reproducible process.

On-line SPE is a powerful method in automated sample preparation where the SPE hardware is technically integrated into a HPLC system. Crude samples are placed in an autosampler and processed fully automatically prior to injection into a GC (MS) or LC (MS) system.

MN offers different on-line column configurations designed to fit your on-line SPE needs and filled with a choice of different adsorbents, modifications and particle sizes:

- Ready-to-use EC columns or ChromCart® cartridges for on-line SPE (standard dimensions 20 × 2 mm or 20 × 4 mm, resp.), filled with CHROMABOND® HR-Xpert phases (15 µm particles) or with NUCLEODUR® C₁₈ ec, C₈ ec, CN (20 µm particles)



EC column



CC-cartridges

- Columns for Gilson® ASPEC™ systems are ready to use assembled with caps. In addition to the columns and phases listed below, all 1, 3 and 6 mL CHROMABOND® polypropylene columns from our program can be supplied assembled with ASP caps.



Columns for the Gilson® ASPEC™

Volume	Adsorbent weight	Pack of [columns]	REF
CHROMABOND® C₁₈ ec			
1 mL	100 mg	100	730011ASP
3 mL	500 mg	100	730013ASP
6 mL	1000 mg	100	730015ASP

- SPE columns equipped with caps and needles to be used in the SPE unit of the Gerstel MultiPurposeSampler (MPS)

Other dimensions and adsorbents on request.



SPE cartridges for Gerstel MPS system



Gerstel MPS system

Volume	Adsorbent weight	Pack of [columns]	REF
CHROMABOND® SiOH			
3 mL	500 mg	50	730073MPS
CHROMABOND® C₁₈ ec			
1 mL	100 mg	100	730011MPS
3 mL	200 mg	50	730012MPS
3 mL	500 mg	50	730013MPS
CHROMABOND® HR-X			
1 mL	100 mg	30	730935MPS
3 mL	200 mg	30	730931MPS
6 mL	500 mg	30	730939MPS

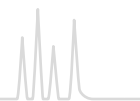

CHROMABOND® MULTI 96 for robot systems

Alternatively CHROMABOND® MULTI 96 plates provide a means of high throughput sample preparation by processing 96 samples in a standard 8 × 12 microcolumn plate format compatible with standard 96-well plate liquid handling technologies and injection systems. MULTI 96 plates are available for solid phase extraction (SPE) and for filtration (see page 98)

CHROMABOND® MULTI 96

- 96-well PP microtiter plates with PE filter elements
- Cavity volume 1.5 mL
- Adsorbent weights 10, 25, 50, 100 mg per microcolumn
- Supplied with any CHROMABOND® SPE adsorbents
- For the simultaneous preparation of 96 samples
- Easy method transfer from CHROMABOND® columns or CHROMAFIX® cartridges to CHROMABOND® MULTI 96

Advantages of this high-throughput system

- Simultaneous preparation of 96 samples; this means a 4-fold increase over traditional 24-position SPE processors
- Economical by saving time and solvent
- Use of multi-channel pipettors facilitates liquid transfer steps
- Readily adaptable to all common automated and robotic handling systems
- Minimized dead volume ($\leq 40 \mu\text{L}$)

Instrument compatibility

CHROMABOND® MULTI 96 SPE microtiter plates as well as CHROMAFIL® MULTI 96 filtration plates are compatible with, e.g., the following liquid handling and SPE automation systems:

- Perkin Elmer MultiProbe® II
- Tomtec Quadra 3® and Quadra 3® SPE
- Hamilton Microlab® SPE Workstation
- Beckman Coulter Biomek® 2000
- Caliper Life Science RapidTrace®
- Gilson® ASPEC™ XL4 and ASPEC™ XL
- Gilson® 215 SPE Liquid Handler
- Tecan Genesis™ FE500
- Eppendorf epMotion®

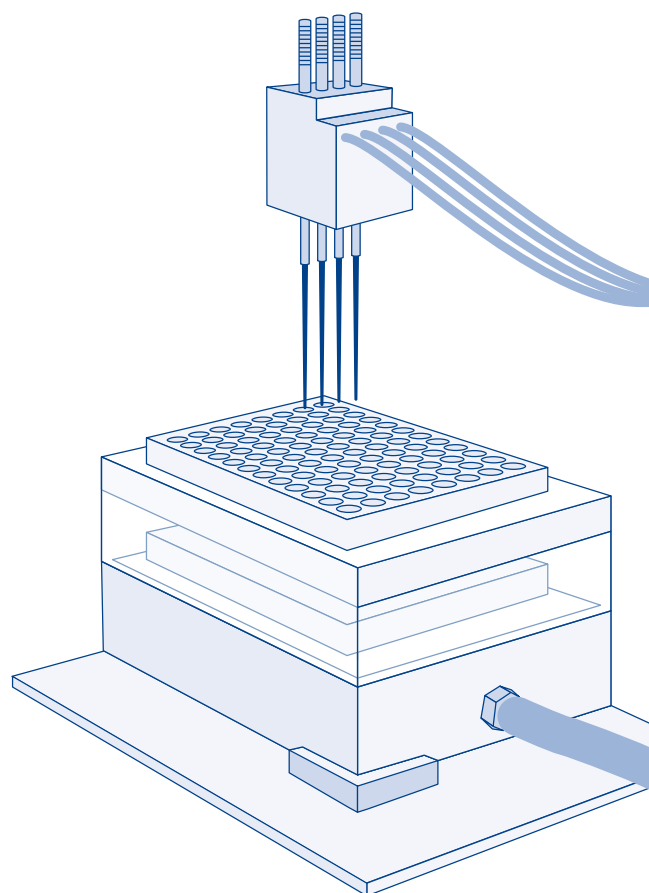



CHROMABOND® MULTI 96 vacuum manifold

For handling of CHROMABOND® MULTI 96 SPE plates for up to 96 samples

CHROMABOND® MULTI 96 is designed for use in common robotic workstations or commercially available liquid handling systems. Alternatively, use of multichannel pipettors facilitates a manual liquid transfer. Extraction is carried out using the CHROMABOND® MULTI 96 vacuum manifold.

With the help of the control valve the vacuum of the manifold can be adjusted leading to an optimum flow rate through the CHROMABOND® MULTI 96 SPE plate.

A reservoir tank and 96-well collection plates (96 × 0.5 or 96 × 2 mL) made of polypropylene can be supplied as accessories.

An interesting alternative for collection of the eluates is a collection rack, which can be fitted with twelve 8-well strips of polypropylene tubes (each 1 mL).

If you have to work on less than 96 samples, you can seal individual rows of the 96-well plate with a PTFE-covered rubber pad.



738639.M



738638



738637

Description	Pack of	REF
CHROMABOND® MULTI 96 accessories		
CHROMABOND® MULTI 96 vacuum manifold with reservoir tank, vacuum gauge, and control valve	1	738630.M
96-well microtiter plates (polypropylene) 96 × 0.25 mL	10	738651
96-deep-well collecting plate (polypropylene) 96 × 2 mL	5	738650.5
Collection racks with polypropylene tube strips (twelve 8-well strips) 96 × 1.0 mL	5	738637
Polypropylene tube strips (twelve 8-well strips) 96 × 1.0 mL	10	738652
8-well strip sealing caps for PP tube strips (REF 738652)	30	738638
Reservoir tanks (polypropylene)	2	738639.M
Butyl rubber pad, PTFE covered for sealing of individual rows of the 96-well plate, 125 × 85 mm	1	738645

For CHROMAFIL® MULTI 96 filter plates see page 98. The ordering information of 96-well plates packed with individual CHROMABOND® adsorbents is listed with the respective phases.

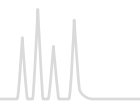

MN Flash adsorbents a unique variety of phases

★ Key features

- Flash columns and cartridges from MACHEREY-NAGEL are available with all CHROMABOND® SPE / Flash packings (more than 40 phases, e.g., C₁₈, C₈, OH, Alox). Additionally you can choose from our range of POLYGOPREP silica packings in particle sizes from 20 to 130 µm and pore sizes from 60 to 4000 Å.
- For high performance Flash separations MACHEREY-NAGEL offers spherical silica featuring very high separation efficiency



Comparison of separation efficiency and price of irregular versus spherical silica

Separation efficiency and reproducibility

Our optimized automatic packing process leads to an excellent packing quality, irrespective of the phase or particle size distribution (normal phase or reversed phase, spherical or irregular particles). MACHEREY-NAGEL, as a manufacturer of silicas, has decades of experience in the production of first class separation phases and columns. This leads to highest separation efficiencies of the columns, a constant back pressure (via controlled narrow particle size distribution) and good reproducibilities from cartridge to cartridge.

🔧 Technical characteristics

Irregular unmodified silica

- Particle sizes: 40–63 µm or 15–40 µm
- Specific surface area: 500 m²/g
- Pore size: 60 Å
- pH stability: 2–8

Spherical unmodified silica

- Particle sizes: 15 µm or 25 µm
- Specific surface area: 700 m²/g
- Pore size: 50 Å
- pH stability: 2–8

Irregular endcapped octadecyl modified (C₁₈ ec) silica

- Particle sizes: 40–63 µm or 15–40 µm
- Specific surface area: 500 m²/g
- Pore size: 60 Å
- pH stability: 2–8

The separation efficiency is in the first place not influenced by the dimension or the geometry of the Flash RS cartridges. The chromatograms below show an identical resolution and peak form for different column dimensions, when flow and sample amount is adjusted correctly. This is advantageous for optimization and upscaling experiments.



Resolution

Resolution (R_s) is influenced by three terms: selectivity, efficiency and retention. The most important parameter to improve resolution (and thereby loading capacity) is the selectivity. It can be altered by using a different type of stationary phase or by changing eluent properties. If this is not possible, efficiency can be increased by choosing smaller particles. The particle size is inversely proportional to the plate numbers and thus to the efficiency. Furthermore, spherical particles with a tight particle size distribution can be packed more uniformly into the cartridges than irregular particles. Those packings often show channeling

or pockets, which causes band spreading and a decrease in resolution. SPHERE SiOH combines those advantages to provide superior resolution in comparison to irregular SiOH as demonstrated in the example chromatograms shown below.

The separation of three structurally related phthalates was performed with three silica packed cartridges under identical conditions (chromatograms below). The use of SPHERE SiOH makes it possible to separate all three compounds within 2.1 min. The irregular silicas showed only incomplete separation.

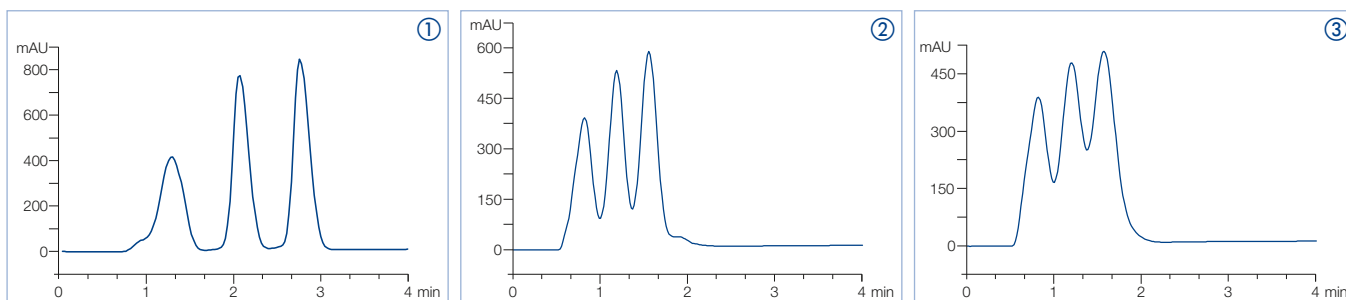

Conditions

Substances: dibutyl phthalate, diethyl phthalate, dimethyl phthalate

Sample loading: 500 mg

Solvent A: cyclohexane

Solvent B: ethyl acetate

Gradient: 20% B to 50% B in 6 min

Flow: 80 mL/min

① CHROMABOND® Flash RS 40 SPHERE SiOH 25 µm

② CHROMABOND® Flash RS 40 SiOH 15 – 40 µm

③ CHROMABOND® Flash RS 40 SiOH 40 – 63 µm

Another example is the separation of two parabens and the structurally related 3,5-dibenzyloxyacetophenone. A SPHERE SiOH packed cartridge provided excellent separation within only 3.3 min. Under identical conditions a baseline separation was not possible with irregular silicas.

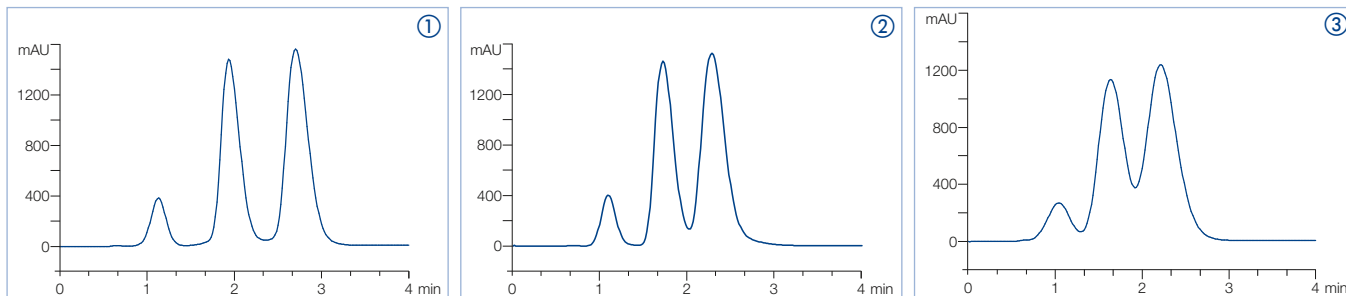

Conditions

Substances: 3,5-dibenzyloxyacetophenone, butylparaben, methylparaben

Sample loading: 165 mg

Solvent A: cyclohexane

Solvent B: ethyl acetate

Gradient: 20% B to 80% B in 4 min

Flow: 80 mL/min

① CHROMABOND® Flash RS 40 SPHERE SiOH 15 µm

② CHROMABOND® Flash RS 40 SiOH 15 – 40 µm

③ CHROMABOND® Flash RS 40 SiOH 40 – 63 µm

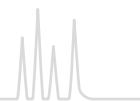

MN TLC and Flash products

- Same selectivity and easy upscaling from TLC to Flash separations
- Saving time and money, because expensive optimizations are not required

TLC is often used for the development of a selective and reproducible method in Flash chromatography, because it is often necessary to test a large number of eluent and/or adsorbent

TLC screening

For TLC separation you should start with an unmodified silica and a nonpolar eluent of low viscosity (e.g., mixtures of *n*-hexane – ethyl acetate or *n*-hexane – acetone). By changing the composition of the eluent the R_f value of the TLC separation is adjusted to approx. 0.3. Increasing polarity of the eluent decreases the R_f

combinations. MN TLC plates and sheets are coated with the same base silica, which is used in our CHROMABOND® Flash cartridges. This is an important prerequisite for the reproducible transfer of a TLC separation to the Flash column, because the parameters are identical in both systems.

values. The difference in R_f values between the substances to be separated should be at least 0.1 to allow a reliable separation in the subsequent flash chromatography. Variation of the eluent components (e.g., acetone, dichloromethane) can be used to enhance the separation by eluent specific selectivity.

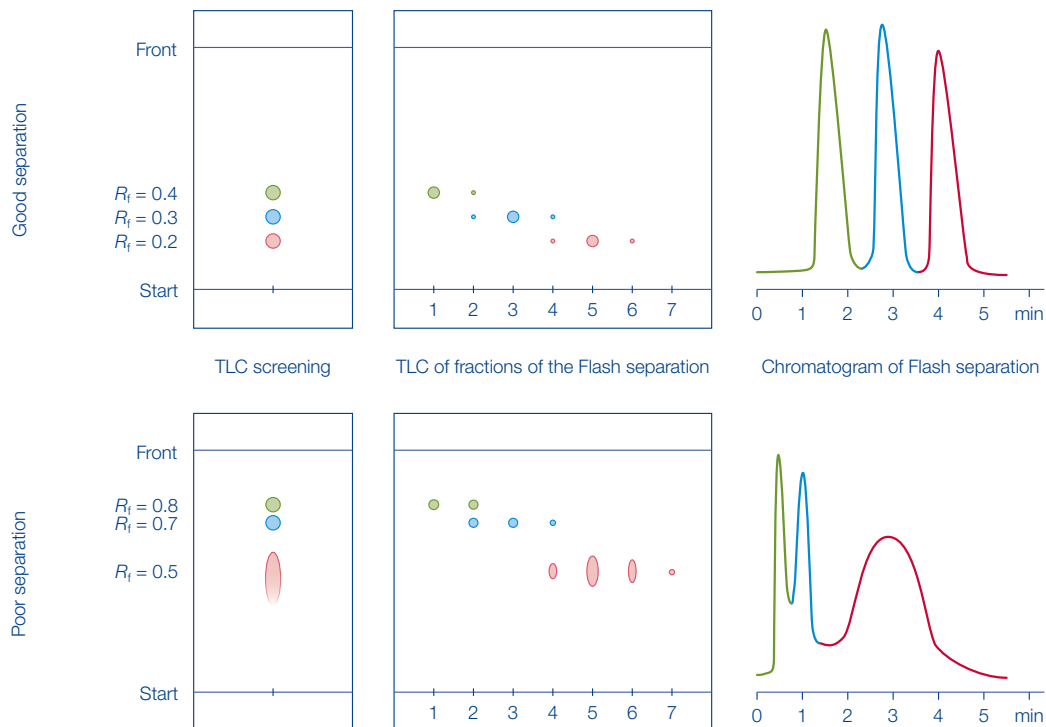

Our program of TLC plates can be found from page 272 onwards.



Back pressure of CHROMABOND® cartridges at typical flow rates

The back pressure always depends on the flow rate and viscosity of the eluent mixture, column length and diameter as well as on the particle size. The high performance CHROMABOND® Flash cartridges are stable up to 21 bar depending on their size.

We recommend using a pressure guard because short time pressure peaks (viscosity of eluent or gradient changes) can exceed the pressure limit.

CHROMABOND® Flash SiOH 40 – 63 µm cartridges (eluent hexane – ethyl acetate 9:1 or 8:2)

Cartridge	20 mL/min	40 mL/min	80 mL/min	120 mL/min	160 mL/min	200 mL/min	240 mL/min
RS/BT 4	0.75 bar	1.5 bar					
RS/BT 15	0.25 bar	0.75 bar	1.5 bar	2.0 bar			
RS/BT 25	0.5 bar	1.0 bar	1.75 bar	3.0 bar	4.0 bar	5.0 bar	
RS/BT 40		0.75 bar	1.5 bar	2.25 bar	3.0 bar	3.25 bar	3.5 bar
RS/BT 80			1.5 bar	2.5 bar	3.0 bar	3.5 bar	4.0 bar
RS/BT 120			1.0 bar	1.5 bar	2.0 bar	2.5 bar	3.0 bar
RS/BT 200			1.0 bar	1.5 bar	2.0 bar	2.5 bar	3.0 bar
RS/BT 330			1.5 bar	2.25 bar	3.0 bar	3.5 bar	4.0 bar

CHROMABOND® Flash SPHERE SiOH cartridges (eluent cyclohexane – ethyl acetate 8:2)

Cartridge	20 mL/min	30 mL/min	40 mL/min	60 mL/min	80 mL/min	120 mL/min	160 mL/min	200 mL/min	240 mL/min
CHROMABOND® Flash RS SPHERE SiOH 15 µm									
RS 4	12 bar	20 bar							
RS 12	4 bar		8 bar		16 bar	18 bar			
RS 25	7 bar		15 bar						
RS 40	5 bar		9 bar		15 bar	16 bar	16 bar	18 bar	19 bar
RS 80	5 bar		10 bar	16 bar					
RS 120	4 bar		7 bar	12 bar	15 bar	20 bar			
RS 220					4 bar	7 bar	9 bar	11 bar	
RS 330			3 bar		6 bar	9 bar	12 bar	13 bar	14 bar
CHROMABOND® Flash RS SPHERE SiOH 25 µm									
RS 4	4 bar		8 bar		16 bar				
RS 12	1 bar		3 bar		7 bar	10 bar	14 bar	17 bar	19 bar
RS 25	2 bar		5 bar		10 bar	15 bar			
RS 40			3 bar		7 bar	10 bar	14 bar	17 bar	19 bar
RS 80			3 bar		7 bar	10 bar	14 bar		
RS 120			2 bar		5 bar	8 bar	11 bar	13 bar	
RS 220					2 bar	3 bar	4 bar	5 bar	7 bar
RS 330					3 bar	4 bar	6 bar	7 bar	9 bar

blank = no measurement conducted

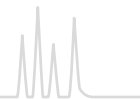

Upscaling of the optimum flow rate and sample loading

Please note that the scale-up factor always depends on the individual separation problem and purification conditions.

To scale-up the sample loading weight the adsorbent weight needs to be adjusted by the scale-up factor (SF). The relation is linear as long as the other scale-up parameters are kept constant.

In case of switching between two cartridge sizes the flow rate needs to be corrected to obtain the same resolution. The scale up-factor for the flow rate (SF_{FR}) depends in the easiest case

on the square root of the column inner diameter (see formula below). In other cases SF_{FR} can be calculated by linear velocity. During the upscaling process the linear velocity of the solvent through the columns should be kept at a constant rate.

$$SF_{FR} = \frac{(ID_{new})^2}{(ID_{old})^2}$$

Conditioning volumes for CHROMABOND® Flash RS / BT cartridges (normally 2 – 6 column volumes of the eluent)

Cartridge	Volume of eluent for conditioning
RS / BT 4	16 – 48 mL
RS / BT 15	60 – 180 mL
RS / BT 25	90 – 270 mL
RS / BT 40	150 – 450 mL
RS / BT 80	320 – 960 mL

Cartridge	Volume of eluent for conditioning
RS / BT 120	440 – 1,320 mL
RS / BT 200	820 – 2460 mL
RS / BT 330	1,200 – 3,600 mL
RS 800	3,590 – 10,770 mL
RS 1600	6,710 – 20,130 mL

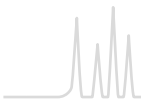

CHROMABOND® Flash cartridges

Complete program of ready-to-use flash cartridges for

- Isco Companion® and other Teledyne Isco CombiFlash® systems
- Biotage® Isolera™, Biotage® FlashMaster™ or as stand-alone version for all pump / detector combinations, e. g., from Biotage®, Büchi
- Yamazen Smart Flash, Interchim® puriFlash® systems

Enhanced flexibility and reliable upscaling

- All common RP and NP phases available on request
- Adsorbent weights from 4 g up to 3,000 g
- Spherical and irregular silica available

Increased analytical safety

- Organic solvent resistant, low bleed polypropylene cartridges, thick column walls, one piece body, optimized length-to-diameter ratio for high plate numbers and excellent separation efficiencies
- Distribution of eluent stream via highly porous filter elements; larger cartridges (≥ 40 g) also contain a distribution plate for optimal flow geometry
- Optimized polypropylene hardware for high pressure stability of up to 21 bar

High quality standard

- All flash cartridges and adsorbents undergo comprehensive during- and after-production quality assurance measures to ensure that the products comply with the specification.
- Tube material is made of pharmaceutical and food grade polypropylene

Outstanding price-performance ratio



CHROMABOND® Flash RS - pictures of CHROMABOND® Flash BT and DL hardware can be found on page 15.



CHROMABOND® Flash RS

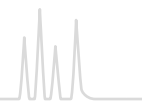

CHROMABOND® Flash RS solutions for Isco® Flash instruments

★ Key features

- Heavy-duty polypropylene cartridges designed for use in Teledyne Isco CombiFlash® systems (Companion®, R_f etc.) without additional connectors or capillaries.
- Column connection:
cartridges up to RS 330: female Luer lock inlet and male Luer outlet
RS 800, RS 1600 and RS 3000: maxi Luers

✓ Recommended application

- Using the CHROMABOND® Flash Starter Kit, REF 730798 or the CHROMABOND® Flash Stand Alone Kit, REF 732903 (see page 82) CHROMABOND® Flash RS cartridges can also be used as stand alone system with any pump / detector / fraction collector combination (except RS 800, RS 1600 and RS 3000 with maxi Luers). For RS 800, RS 1600 and RS 3000 there are additional adaptations to the cartridge itself necessary. Please contact our support team for more information.

Cartridge	Column length [cm]	ID [mm]	Adsorbent weight [g]	Loading capacity *	Typical flow rate [mL/min]	Max. pressure [bar / psi]	Pack of	REF
CHROMABOND® Flash RS SiOH 40–63 µm								
RS 4	10.6	12.4	4	4 mg – 0.4 g	10–35	21/305	20	732800
RS 15	12.5	21.2	15	15 mg – 1.5 g	25–55	21/305	20	732801
RS 25	17.3	21.2	25	25 mg – 2.5 g	25–55	21/305	15	732802
RS 40	17.6	26.7	40	40 mg – 4.0 g	35–65	21/305	15	732803
RS 80	24.9	30.9	80	80 mg – 8.0 g	45–95	14/203	12	732804
RS 120	26.2	37.2	120	120 mg – 12 g	55–140	14/203	10	732805
RS 200	21.6	59.4	200	200 mg – 20 g	75–210	11/160	6	732806
RS 330	28.0	59.8	330	330 mg – 33 g	75–210	11/160	4	732807
RS 800	38.3	78.2	800	800 mg – 80 g	140–240	7/102	2	732808
RS 1600	43.2	103.8	1600	1.6 g – 160 g	190–250	7/102	2	732809
RS 3000	51.0	127.5	3000	3 g – 300 g	240–390	7/102	1	732850
CHROMABOND® Flash RS SiOH 15–40 µm								
RS 4	10.6	12.4	4	4 mg – 0.6 g	10–50	21/305	20	732700
RS 15	12.5	21.2	15	15 mg – 2.3 g	25–70	21/305	20	732701
RS 25	17.3	21.2	25	25 mg – 3.8 g	25–70	21/305	15	732702
RS 40	17.6	26.7	40	40 mg – 6.0 g	35–80	21/305	15	732703
RS 80	24.9	30.9	80	80 mg – 12 g	45–105	14/203	12	732704
RS 120	26.2	37.2	120	120 mg – 18 g	55–155	14/203	10	732705
RS 200	21.6	59.4	200	200 mg – 30 g	75–255	11/160	6	732706
RS 330	28.0	59.8	330	330 mg – 49 g	75–255	11/160	4	732707
RS 800	38.3	78.2	800	800 mg – 120 g	100–300	7/102	2	732708
RS 1600	43.2	103.8	1600	1.6 g – 240 g	200–500	7/102	2	732709

* Orientation value

Cartridge	Column length [cm]	ID [mm]	Adsorbent weight [g]	Loading capacity *	Typical flow rate [mL/min]	Max. pressure [bar / psi]	Pack of	REF
CHROMABOND® Flash RS C₁₈ ec 40–63 µm								
RS 4	10.6	12.4	4.3	4 mg – 86 mg	10–35	21/305	2	732810
RS 15	12.5	21.2	16.4	16 mg – 328 mg	25–55	21/305	1	732811
RS 25	17.3	21.2	26	26 mg – 520 mg	25–55	21/305	1	732812
RS 40	17.6	26.7	43	55 mg – 860 mg	35–65	21/305	1	732813
RS 80	24.9	30.9	86	86 mg – 1.72 g	45–95	14/203	1	732814
RS 120	26.2	37.2	130	130 mg – 2.6 g	55–140	14/203	1	732815
RS 200	21.6	59.4	220	220 mg – 4.4 g	75–210	11/160	1	732816
RS 330	28.0	59.8	360	360 mg – 7.2 g	75–210	11/160	1	732817
RS 800	38.3	78.2	880	880 mg – 17.6 g	140–240	7/102	1	732818
RS 1600	43.2	103.8	1760	1.76 g – 35.2 g	190–250	7/102	1	732819
CHROMABOND® Flash RS C₁₈ ec 15–40 µm								
RS 4	10.6	12.4	4.3	4 mg – 86 mg	10–25	21/305	2	732720

* Orientation value



Cartridge	Column length [cm]	ID [mm]	Adsorbent weight [g]	Loading capacity *	Typical flow rate [mL/min]	Max. pressure [bar / psi]	Pack of	REF
RS 15	12.5	21.2	16.4	16 mg–328 mg	25–70	21/305	1	732711
RS 25	17.3	21.2	26	26 mg–520 mg	25–70	21/305	1	732712
RS 40	17.6	26.7	43	55 mg–860 mg	35–80	21/305	1	732713
RS 80	24.9	30.9	86	86 mg–1.72 g	45–105	14/203	1	732714
RS 120	26.2	37.2	130	130 mg–2.6 g	55–155	14/203	1	732715
RS 200	21.6	59.4	220	220 mg–4.4 g	75–255	11/160	1	732716
RS 330	28.0	59.8	360	360 mg–7.2 g	75–255	11/160	1	732717
RS 800	38.3	78.2	880	880 mg–17.6 g	100–300	7/102	1	732718
RS 1600	43.2	103.8	1760	1.76 g–35.2 g	200–500	7/102	1	732719

* Orientation value

Cartridge	Column length [cm]	ID [mm]	Adsorbent weight [g]	Loading capacity *	Typical flow rate [mL/min] **	Max. pressure [bar / psi]	Pack of	REF
CHROMABOND® Flash RS SPHERE SiOH 25 µm								
RS 4	10.6	12.4	4	4 mg–1.2 g	10–30	21/305	20	732460
RS 15	12.5	21.2	12	12 mg–3.6 g	20–45	21/305	20	732461
RS 25	17.3	21.2	25	25 mg–7.5 g	20–45	21/305	15	732462
RS 40	17.6	26.7	40	40 mg–12 g	25–55	21/305	15	732463
RS 80	24.9	30.9	80	80 mg–24 g	35–75	14/203	12	732464
RS 120	26.2	37.2	120	120 mg–36 g	40–85	14/203	10	732465
RS 200	21.6	59.4	220	220 mg–66 g	55–110	11/160	6	732466
RS 330	28.0	59.8	330	330 mg–99 g	55–110	11/160	4	732467

CHROMABOND® Flash RS SPHERE SiOH 15 µm

RS 4	10.6	12.4	4	4 mg–1.2 g	10–20	21/305	20	732760
RS 15	12.5	21.2	12	12 mg–3.6 g	20–45	21/305	20	732761
RS 25	17.3	21.2	25	25 mg–7.5 g	20–45	21/305	15	732762
RS 40	17.6	26.7	40	40 mg–12 g	25–55	21/305	15	732763
RS 80	24.9	30.9	80	80 mg–24 g	35–75	14/203	12	732764
RS 120	26.2	37.2	120	120 mg–36 g	40–85	14/203	10	732765
RS 200	21.6	59.4	220	220 mg–66 g	55–110	11/160	6	732766
RS 330	28.0	59.8	330	330 mg–99 g	55–110	11/160	4	732767

* Orientation value

** For column conditioning we recommend a maximum flow rate of 20–30 mL/min.

On request, most column types listed above can be packed with any adsorbent from our program of CHROMABOND® adsorbents (starting from page 16). Please note that other packings often result in differing adsorbent weights.

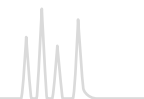

CHROMABOND® Flash BT solutions for Biotage® Flash instruments

★ Key features

- Heavy-duty polypropylene cartridges designed for use in the Biotage® Isolera™ systems without additional connectors or capillaries.
- Column connection: female Luer lock inlet and male Luer lock outlet

✓ Recommended application

- Using the CHROMABOND® Flash Starter Kit, REF 730798 or the CHROMABOND® Flash Stand Alone Kit, REF 732903 (see page 82) CHROMABOND® Flash BT cartridges can also be used as stand alone system with any pump / detector / fraction collector combination.

🔧 Technical characteristics

- Irregular unmodified silica
- Particle size: 40 – 63 µm
- Specific surface area: 500 m²/g
- Pore size: 60 Å
- pH stability: 2 – 8

Description	Column length [cm]	ID [mm]	Adsorbent weight [g]	Pack of	REF
CHROMABOND® Flash BT columns with Luer lock exit					
Filled with unmodified standard silica, 40 – 63 µm, specific surface 500 m ² /g, pH stability 2 – 8					
CHROMABOND® Flash BT 4 SiOH	10.6	12.4	4	20	732960
CHROMABOND® Flash BT 15 SiOH	12.5	21.2	15	20	732961
CHROMABOND® Flash BT 25 SiOH	17.3	21.2	25	15	732962
CHROMABOND® Flash BT 40 SiOH	17.6	26.7	40	15	732963
CHROMABOND® Flash BT 80 SiOH	24.9	30.9	80	12	732964
CHROMABOND® Flash BT 120 SiOH	26.2	37.2	120	10	732965
CHROMABOND® Flash BT 200 SiOH	21.6	59.4	200	6	732966
CHROMABOND® Flash BT 330 SiOH	28.0	59.4	330	4	732967

On request, all most column types listed above can be packed with any adsorbent from our program of CHROMABOND® adsorbents (starting from page 16). Please note that other packings often result in differing adsorbent weights.

CHROMABOND® Flash DL cartridges solutions for direct loading

★ Key features

- Column connection: female Luer lock inlet and male Luer lock outlet. Each cartridge comes with 3 filter elements: one already inserted, two more filters aside.
- Suitable as solid injection system
- For individual self-filling and packing of flash cartridges

Description	Column length [cm]	ID [mm]	For adsorbent weight [g]		Volume [mL]	Empty column Pack of	REF	PE filter elements	
			SiOH	Kieselguhr				Pack of	REF
CHROMABOND® Flash DL empty cartridges									
CHROMABOND® Flash DL 4	10.6	12.4	4	3	8	50	732980	250	732980FE
CHROMABOND® Flash DL 15	12.5	21.2	15	10	30	50	732981	250	732981FE
CHROMABOND® Flash DL 25	17.3	21.2	25	15	45	50	732982	250	732982FE
CHROMABOND® Flash DL 40	17.6	26.7	40	30	75	20	732983	250	732983FE
CHROMABOND® Flash DL 80	24.9	30.9	80	60	160	20	732984	250	732984FE
CHROMABOND® Flash DL 120	26.2	37.2	120	80	220	20	732985	250	732985FE
CHROMABOND® Flash DL 200	21.6	59.4	200	150	410	10	732986	100	732986FE
CHROMABOND® Flash DL 330	28.0	59.4	330	250	600	10	732987	100	732987FE

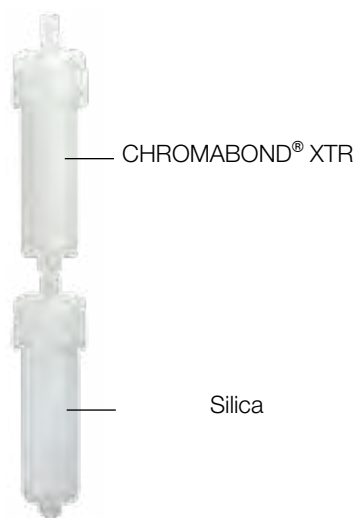

CHROMABOND® Flash DL cartridge filled with sample on CHROMABOND® XTR on top of CHROMABOND® Flash RS or BT silica cartridge

Options for solid injection

The sample is dissolved in a suitable solvent and adsorbed onto CHROMABOND® XTR (diatomaceous earth, see page 64). After removal/ evaporation of the residual solvent, the adsorbent is filled into an empty CHROMABOND® Flash DL cartridge.

Our XTR adsorbents can be found on page 64.

Custom filling sizes are available on request.



CHROMABOND® Flash connecting kits

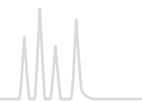

CHROMABOND® Flash connecting kits allow to use CHROMABOND® Flash RS and BT cartridges as stand-alone system with any pump, detection, fraction collector combination.



REF 730798 CHROMABOND® Flash Starter kit

Female Luer lock for column inlet



Male Luer lock for column exit

REF 732903 CHROMABOND® Flash Stand Alone Kit, Luer

Description	Pack of	REF
CHROMABOND® Flash Starter kit consists of 1/8" PTFE tubing, 1.5 mm ID, 3 m long; 5 x 1/4"-28 PP nuts; 5 x 1/8" ETFE ferrules; 5 x 1/4"-28 nylon unions; 2 x 1/4"-28 PP Luer lock, female; 1 x 1/4"-28 PP Luer lock, male; 1 x 1/4"-28 PP Luer tip, male	1 kit	730798
CHROMABOND® Flash "Stand Alone" Kit, Luer consists of 1 x 1/4"-28 PP Luer lock, female; 1 x 1/4"-28 PP Luer lock, male; 2 x 1/8" ETFE ferrules; 2 x 1/4"-28 nylon unions; 2 x 1/4"-28 PP nuts	1 kit	732903



Glass columns and accessories for Flash chromatography

★ Key features

- MN flash chromatography kits include a glass column, eluent reservoir, silica 60 and accessories. Glass columns of different sizes and accessories can be ordered separately.
- These columns are normally filled to a height of about 15 cm, working pressures are 1.5 to 2 bar.
- The most used adsorbent is silica 60 with particle size 40–63 µm (see page 267), however, you may also use our ranges of other LC adsorbents and of POLYGOPREP silica phases (see page 266). Particle sizes < 25 µm should only be used with very low-viscosity mobile phases, because otherwise flow rates will be very low.
- This columns are packed by the user.
- No expensive equipment required

✓ Recommended application

- Economic low-tech method for the synthesis laboratory
- Suited for the separation of compounds up to gram levels

Description	Pack of	REF
Flash chromatography kits		
Flash chromatography kit I consists of 1 glass column 20 mm ID x 400 mm length, one 1-L eluent reservoir, 100 g silica 60 (40–63 µm), sea sand, silanized glass fiber wadding, 1 m PTFE tubing	1 kit	727450
Flash chromatography kit II consists of 1 glass column 40 mm ID x 450 mm length, one 2-L eluent reservoir, 100 g silica 60 (40–63 µm), sea sand, silanized glass fiber wadding, 1 m PTFE tubing	1 kit	727451
Flash chromatography glass columns complete with adapter and PTFE tap, fitted with a polyethylene net to protect against bursting		
20 mm ID x 400 mm length	1 column	727401
40 mm ID x 450 mm length	1 column	727407
Accessories for flash chromatography glass columns		
1-L eluent reservoir with adapter, covered with a protective plastic sleeve for burst protection; this also prevents build-up of UV-induced radicals in the eluent	1 piece	727420
2-L eluent reservoir as above	1 piece	727421
Pressure gauge for controlling flow rates	1 piece	727422
PTFE tubing, 3 mm OD, 2 mm ID, length 1 m	1 m	727424
Sea sand, acid washed and calcined	1 kg	727423
Glass fiber wadding, silanized	25 g	718002

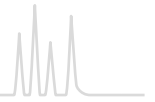

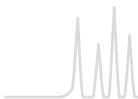

Contents

Basics.....	86
Selection guide for syringe filters.....	88
CHROMAFIL® combi filters.....	89
CHROMAFIL® syringe filters.....	90
Chemical compatibility of CHROMAFIL®.....	97
CHROMAFIL® filtration cartridges · MULTI 96.....	98

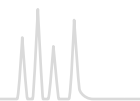

Sample filtration

Syringe filters are used for the filtration of suspended matter from liquid samples or gases. With CHROMAFIL® rapid purification and removal of particles is very simple: just place the filter on the syringe and you are ready for filtration. Special manipulations are not required. The contamination of sensitive instrumentation by solid impurities can be avoided, which leads to an increase of lifetime of chromatographic columns and equipment.

Advantages

Polypropylene housing

- Considerably better solvent stability compared to acrylate and polystyrene filters, featuring a low content of extractable substances

Lowest content of extractable substances

- The housing of every CHROMAFIL® filter is ultrasonically sealed (welded), not glued, because glue may have extractable ingredients. Welding leads to a tight connection between both parts, thus the filter can be used in both directions. The special thick rim of the housing is ideal for use in laboratory robots (e. g., SOTAX®, Benchmate™).

Luer lock on the side of entry

- For a safe connection on the high-pressure side every filter provides a Luer lock on the side of entry.

Luer exit

- For 3, 13 and 25 mm type filters: standard Luer exit
- For 15 mm type filters: minispike · This Luer configuration offers a low hold-up volume and easy filtration into autosampler vials and NMR tubes.
- With the aid of a special adapter, filter inlet and filter exit can be fitted to all CHROMABOND® columns and accessories for selective sample preparation.

No rupture of membrane due to the impact plate

- The input solvent stream is broken and distributed by the impact plate and does not directly hit the membrane: this prevents rupture of the membrane. The high pressure stream is diverted into four lanes.

Optimum flow geometry because of the star-shaped distribution device

- The stream of liquid is broken into 4 lanes by the impact plate and then further distributed to 8 slots in the form of a star connected with 5 or 8 circular channels (for 13, 15 and 25 mm type filters, respectively). Thus, the fluid is able to penetrate the membrane on the whole surface, not only on a small region; the filter is not plugged up rapidly, which results in a high-flow efficiency.

Color coded filters

- Filters with 0.2 µm pores have a yellow upper shell, that of filters with 0.45 µm pores is colorless; the different membrane types are distinguished by different colors of the lower shell.

Different pore sizes for versatile filtration

- Standard pore sizes 0.2 and 0.45 µm (additionally: PET filters with 1.2 µm, glass fiber filters with 1 µm, PES filters with 5 µm). Filters with 0.45 µm pore size efficiently remove fine particles that can plug chromatography columns. Filters with 0.2 µm pore size are excellent for filtration of UHPLC samples or other techniques requiring high purity samples.

Filter sizes

- Recommended filter type depending on sample volume

Sample volume	Recommended filter type	Effective membrane diameter*
≤ 1 mL	3 mm	3 mm
1 – 5 mL	13 mm, 15 mm	15.6 mm
5 – 100 mL	25 mm	22 mm

*Standardized measurement since June 2023. The product has not been modified.

- The small diameter filters are especially recommended for very small samples, which require extremely low dead volumes:
- 5 µL for 3 mm type, 30 µL for 13 mm type, 35 µL for 15 mm type, 80 µL for 25 mm type

Filters can be autoclaved at 121 °C, 1.1 bar for 30 min.

All 25 mm type CHROMAFIL® filters are designed to be 100 % compatible and reliable for use with the SOTAX® AT70 smart fully automated dissolution testing systems.



Depending on your filtration task you can choose filter membranes made from different materials:

Material	Page
Combi filters with glass fiber prefilters	
Polyamide (Nylon) (GF/PA)	89
Polytetrafluoroethylene (GF/PTFE)	89
Polyester (GF/PET)	90
Regenerated cellulose (GF/RC)	90
Polyvinylidene difluoride (GF/PVDF)	90
Syringe filters without prefilters	
Polyester (PET)	91
Regenerated cellulose (RC)	91
Polytetrafluoroethylene (PTFE)	92
Hydrophilized polytetrafluoroethylene (H-PTFE)	92
Cellulose mixed esters (MV)	93
Cellulose acetate (CA) · sterile and non-sterile	93
Polyamide / Nylon (PA)	94
Polyethersulfone (PES)	94
Polyvinylidene difluoride (PVDF)	91
Glass fiber (GF)	91
Special filter for ion chromatography (IC)	92

CHROMAFIL® Xtra

Labeled for method validation and certification

- Xtra: imprint for direct identification of the membrane type, filter type and pore size
- Xtra: low bleeding PP housing
- Xtra: color-free plain polypropylene



CHROMAFIL® BIGbox

- 400 color-coded quality syringe filters or 400 labeled Xtra syringe filters (25 mm type)
- 800 color-coded quality syringe filters (15 mm type)
- Food safe PE box with screw cap

CHROMAFIL® combi filters

Combi syringe filters with a coarse glass fiber prefilter and a small pore membrane as main filter

User benefits:

- For solutions with a high load of particulate matter: lower back pressure, easy filtration
- For high yields of filtrate: more mL of pure filtrate per filter

The technology

The glass fiber membrane (1.0 µm) removes coarse particles, before they can block the fine main membrane. This results in a better filtration efficiency, especially for highly contaminated samples.

- Housing: solvent-resistant, ultra low bleeding polypropylene
- Inlet: luer lock
- Exit: luer
- Pore size: 1.0/0.20 µm or 1.0/0.45 µm
- Filter type: 25 mm
- Dead volume: < 80 µL
- Packing unit: 100 filters; BIGbox with 400 filters

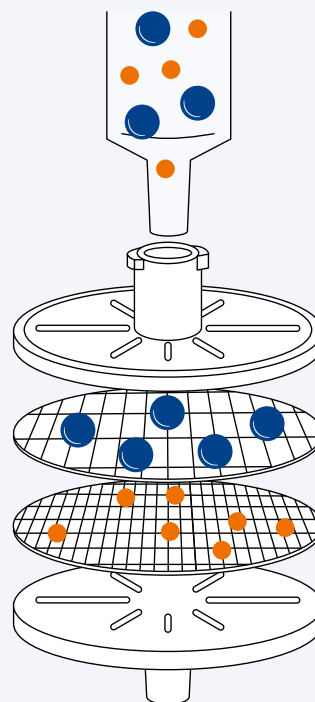



Selection guide for syringe filters

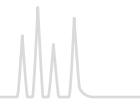

How to select the optimal CHROMAFIL® syringe filter

1. Filter size

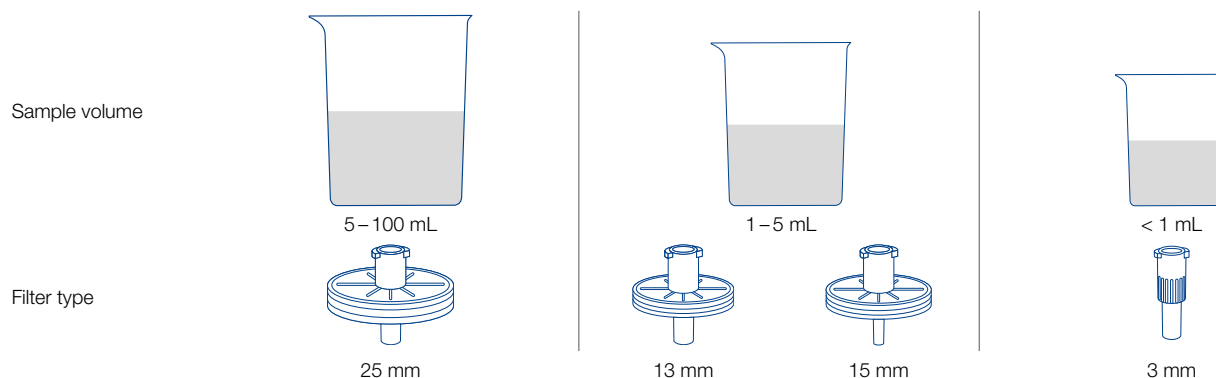

2. Pore size of filter membrane

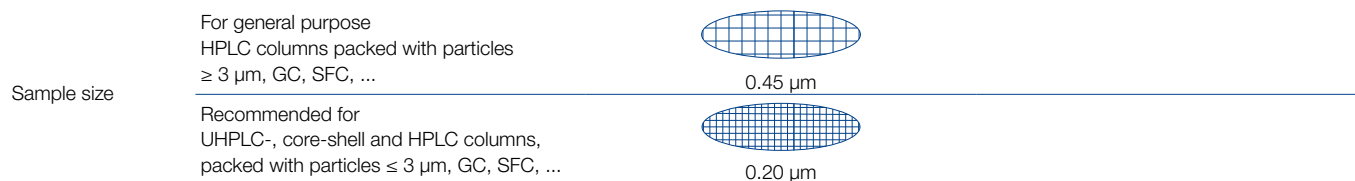

3. Membrane type

Properties of sample	Recommended	Alternatives
Aqueous, polar hydrophilic		
Low particle-load	PET	H-PTFE, MV, RC
High particle-load, prefiltration required	GF/PET	GF/RC, GF/PVDF
Mid-polar e. g. HPLC eluents		
Low particle-load	PET	PA, RC
High particle-load, prefiltration required	GF/PET	GF/PA
Proteins		
Low binding capacity of proteins	CA	PVDF, PES
High binding capacity of proteins	GF	GF/PVDF, GF/PET
Strong acids and bases		
Low particle-load	H-PTFE	PTFE
High particle-load, prefiltration required	GF/PTFE	GF
Organic, nonpolar, hydrophob		
Low particle-load	PTFE	PET
High particle-load, prefiltration required	GF/PTFE	GF/PET, GF/PVDF
Aqueous, for ion chromatography determinations	IC	



MACHEREY-NAGEL

CHROMAFIL Finder · easy switching to first-class filters

It is that simple

1. Choose previously used manufacturer
2. Choose previously used part number
3. Start searching
4. Suitable CHROMAFIL® syringe filter will be suggested

Use our CHROMAFIL Finder online at
www.mn-net.com/chromafilfinder





Polyamide (Nylon) with glass fiber prefilter (GF/PA)



★ Key features

- Moderately hydrophilic membrane
- For aqueous and organic/aqueous medium polar liquids
- Recommended for solutions with a high load of particulate matter or for highly viscous samples. Glass fiber exhibits a high protein-binding capacity.

Type	Pore size [µm]	Effective membrane diameter [mm]		Standard pack Filters/Pack	REF
Xtra GF/PA-20/25	1.0/0.20	22	labeled	100	729260
Xtra GF/PA-45/25	1.0/0.45	22	labeled	100	729261

Polytetrafluoroethylene with glass fiber prefilter (GF/PTFE)



★ Key features

- Hydrophobic membrane
- For nonpolar liquids and gases
- Very resistant to all kinds of solvents as well as acids and bases; flushing with alcohol, followed by water, makes the originally hydrophobic membrane more hydrophilic
- Recommended for solutions with a high load of particulate matter or for highly viscous aqueous solutions. Glass fiber exhibits a high protein-binding capacity.

Type	Pore size [µm]	Effective membrane diameter [mm]		Standard pack Filters/Pack	REF
Xtra GF/PTFE-20/25	1.0/0.20	22	labeled	100	729270
Xtra GF/PTFE-45/25	1.0/0.45	22	labeled	100	729271



Certificates of CHROMAFIL® syringe filters are online available

You can quickly and easily access the CoA of CHROMAFIL® syringe filters in two ways:

1. General website

Go to MN Chromatography homepage & Click on Chromatography service:

<https://www.mn-net.com/chromatography-service>

Choose Certificates of Analysis; type in the REF and LOT number; download PDF

2. Product website

Go to the individual product website, click on „Certificates of analysis“, enter the relevant LOT number and download PDF

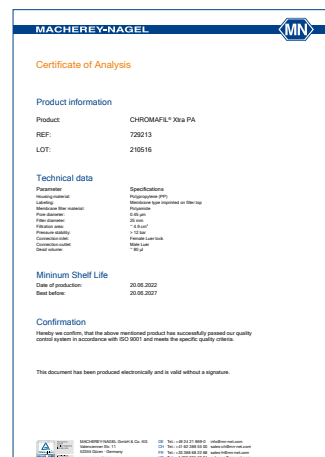

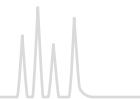

Polyester with glass fiber prefilter (GF/PET)



★ Key features

- Hydrophilic multipurpose membrane
- For polar as well as nonpolar samples
- The HPLC filter with glass fiber prefilter, especially suited for mixtures of water and organic solvents
- Recommended for solutions with a high load of particulate matter or for highly viscous samples. Glass fiber exhibits a high protein-binding capacity.

Type	Pore size [μm]	Effective membrane diameter [mm]	Color code		Standard pack		BIGbox	
			Top	Bottom	Filters/pack	REF	Filters/pack	REF
GF/PET-20/25	1.0/0.20	22	blue	orange	100	729032	400	729032.400
GF/PET-45/25	1.0/0.45	22	black	orange	100	729033	400	729033.400

Regenerated cellulose with glass fiber prefilter (GF/RC)



★ Key features

- Hydrophilic membrane
- For aqueous and organic-aqueous liquids, i. e. polar and medium polar sample solutions
- Recommended for solutions with a high load of particulate matter or for highly viscous aqueous solutions. Glass fiber exhibits a high protein-binding capacity.

Type	Pore size [μm]	Effective membrane diameter [mm]	Color code		Standard pack		BIGbox	
			Top	Bottom	Filters/pack	REF	Filters/pack	REF
GF/RC-20/25	1.0/0.20	22	blue	blue	100	729050	400	729050.400
GF/RC-45/25	1.0/0.45	22	black	blue	100	729051	400	729051.400

Polyvinylidene difluoride with glass fiber prefilter (GF/PVDF)



★ Key features

- Hydrophilic membrane
- Recommended for the filtration of biological samples with high particle loads. Glass fiber exhibits a high proteinbinding capacity.
- Also suited for the filtration of aqueous samples

Type	Pore size [μm]	Effective membrane diameter [mm]	Color code		Standard pack		BIGbox	
			Top	Bottom	Filters/pack	REF	Filters/pack	REF
GF/PVDF-45/25	1.0/0.45	22	black	white	100	729039	400	729039.400



Polyester (PET)



★ Key features

- Hydrophilic multipurpose membrane
- For polar as well as nonpolar solvents
- The HPLC filter, especially suited for mixtures of water and organic solvents
- For TOC/DOC determination
- Not cytotoxic, does not inhibit the growth of microorganisms and higher cells

CHROMAFIL® Xtra

Type	Pore size [µm]	Effective membrane diameter [mm]		Standard pack Filters/pack	REF	BIGbox Filters/pack	REF
PET-20/13	0.20	15.6	labeled	100	729222		
PET-45/13	0.45	15.6	labeled	100	729223		
PET-20/25	0.20	22	labeled	100	729221	400	729221.400
PET-45/25	0.45	22	labeled	100	729220	400	729220.400
PET-120/25	1.2	22	labeled	100	729229	400	729229.400

CHROMAFIL®

Type	Pore size [µm]	Effective membrane diameter [mm]	Color code Top	Bottom	Standard pack Filters/pack	REF	BIGbox Filters/pack	REF
PET-20/15 MS	0.20	15.6	yellow	orange	100	729022	800	729022.800
PET-45/15 MS	0.45	15.6	colorless	orange	100	729023	800	729023.800
PET-20/25	0.20	22	yellow	orange	100	729021	400	729021.400
PET-45/25	0.45	22	colorless	orange	100	729020	400	729020.400

MS = minispikes on filter exit

Regenerated cellulose (RC)



★ Key features

- Hydrophilic membrane with very low adsorption
- For aqueous and organic aqueous liquids, i. e. polar and medium polar sample solutions
- Binding capacity for proteins 84 µg per 25 mm filter

CHROMAFIL® Xtra

Type	Pore size [µm]	Effective membrane diameter [mm]		Standard pack Filters/pack	REF	BIGbox Filters/pack	REF
RC-20/13	0.20	15.6	labeled	100	729236		
RC-45/13	0.45	15.6	labeled	100	729237		
RC-20/25	0.20	22	labeled	100	729230	400	729230.400
RC-45/25	0.45	22	labeled	100	729231	400	729231.400

CHROMAFIL®

Type	Pore size [µm]	Effective membrane diameter [mm]	Color code Top	Bottom	Standard pack Filters/pack	REF	BIGbox Filters/pack	REF
RC-20/15 MS	0.20	15.6	yellow	blue	100	729036	800	729036.800
RC-45/15 MS	0.45	15.6	colorless	blue	100	729037	800	729037.800
RC-20/25	0.20	22	yellow	blue	100	729030	400	729030.400
RC-45/25	0.45	22	colorless	blue	100	729031	400	729031.400

MS = minispikes on filter exit

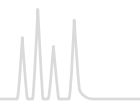

Polytetrafluoroethylene (PTFE)



★ Key features

- Hydrophobic membrane
- For nonpolar liquids and gases
- Very resistant towards all kinds of solvents as well as acids and bases
- Flushing with alcohol, followed by water, makes the originally hydrophobic membrane more hydrophilic

CHROMAFIL[®] Xtra

Type	Pore size [μm]	Effective membrane diameter [mm]		Standard pack Filters/pack	REF	BIGbox Filters/pack	REF
PTFE-20/13	0.20	15.6	labeled	100	729208		
PTFE-45/13	0.45	15.6	labeled	100	729209		
PTFE-20/25	0.20	22	labeled	100	729207	400	729207.400
PTFE-45/25	0.45	22	labeled	100	729205	400	729205.400
PTFE-100/25	1.0	22	labeled	100	729247		

CHROMAFIL[®]

Type	Pore size [μm]	Effective membrane diameter [mm]	Color code Top	Bottom	Standard pack Filters/pack	REF	BIGbox Filters/Pack	REF
PTFE-20/3	0.20	3	colorless	colorless	100	729014		
PTFE-45/3	0.45	3	colorless	colorless	100	729015		
PTFE-20/15 MS	0.20	15.6	yellow	colorless	100	729008	800	729008.800
PTFE-45/15 MS	0.45	15.6	colorless	colorless	100	729009	800	729009.800
PTFE-20/25	0.20	22	yellow	colorless	100	729007	400	729007.400

MS = minispikes on filter exit

Hydrophilized polytetrafluoroethylene (H-PTFE)



★ Key features

- Hydrophobic membrane with additional hydrophilic characteristic
- For polar and nonpolar solutions
- Resistant towards all kinds of solvents as well as acids and bases

CHROMAFIL[®] Xtra

Type	Pore size [μm]	Effective membrane diameter [mm]		Standard pack Filters/pack	REF	BIGbox Filters/pack	REF
H-PTFE-20/13	0.20	15.6	labeled	100	729256		
H-PTFE-45/13	0.45	15.6	labeled	100	729257		
H-PTFE-20/25	0.20	22	labeled	100	729245	400	729245.400
H-PTFE-45/25	0.45	22	labeled	100	729246	400	729246.400



Cellulose mixed esters (MV)



★ Key features

- Hydrophilic membrane with very low adsorption
- For aqueous or polar solutions

CHROMAFIL[®] Xtra

Type	Pore size [µm]	Effective membrane diameter [mm]		Standard pack Filters/pack	REF	BIGbox Filters/pack	REF
MV-20/25	0.20	22	labeled	100	729206		
MV-45/25	0.45	22	labeled	100	729204	400	729204.400

CHROMAFIL[®]

Type	Pore size [µm]	Effective membrane diameter [mm]	Color code Top	Bottom	Standard pack Filters/pack	REF	BIGbox Filters/Pack	REF
MV-20/25	0.20	22	yellow	yellow	100	729006	400	729006.400
MV-45/25	0.45	22	colorless	yellow	100	729004	400	729004.400

Cellulose acetate (CA)



★ Key features

- Hydrophilic membrane
- For the filtration of water-soluble oligomers and polymers, especially suited for biological macromolecules
- Very high shape stability in aqueous solutions
- Extremely low binding capacity for proteins (21 µg / 25 mm type filter)
- Also available in a sterile package (S) for filtration under sterile conditions (each filter individually sealed)

CHROMAFIL[®] Xtra

Type	Pore size [µm]	Effective membrane diameter [mm]		Standard pack Filters/pack	REF	BIGbox Filters/pack	REF
CA-20/13	0.20	15.6	labeled	100	729254		
CA-45/13	0.45	15.6	labeled	100	729255		
CA-20/25	0.20	22	labeled	100	729226	400	729226.400
CA-45/25	0.45	22	labeled	100	729227	400	729227.400

CHROMAFIL[®]

Type	Pore size [µm]	Effective membrane diameter [mm]	Color code Top	Bottom	Standard pack Filters/pack	REF	BIGbox Filters/Pack	REF
CA-20/25	0.20	22	yellow	red	100	729026	400	729026.400
CA-45/25	0.45	22	colorless	red	100	729027	400	729027.400
Sterile filters								
CA-20/25 (S)	0.20	22	yellow	red	50	729024		
CA-45/25 (S)	0.45	22	colorless	red	50	729025		

MS = minispikes on filter exit; S = sterile filters



CHROMAFIL[®] syringe filters



Polyamide (PA) = Nylon



★ Key features

- Moderately hydrophilic membrane
- For aqueous and organic aqueous medium polar liquids

CHROMAFIL[®] Xtra

Type	Pore size [μm]	Effective membrane diameter [mm]		Standard pack Filters/pack	REF	BIGbox Filters/pack	REF
PA-20/13	0.20	15.6	labeled	100	729248		
PA-45/13	0.45	15.6	labeled	100	729249		
PA-20/25	0.20	22	labeled	100	729212	400	729212.400
PA-45/25	0.45	22	labeled	100	729213	400	729213.400

CHROMAFIL[®]

Type	Pore size [μm]	Effective membrane diameter [mm]	Color code Top	Bottom	Standard pack Filters/pack	REF	BIGbox Filters/Pack	REF
PA-20/3	0.20	3	colorless	colorless	100	729010		
PA-45/3	0.45	3	colorless	colorless	100	729011		
PA-20/15 MS	0.20	15.6	yellow	green	100	729048	800	729048.800
PA-45/15 MS	0.45	15.6	colorless	green	100	729049	800	729049.800
PA-20/25	0.20	22	yellow	green	100	729012	400	729012.400
PA-45/25	0.45	22	colorless	green	100	729013	400	729013.400

MS = minispikes on filter exit

Polyethersulfone (PES)



★ Key features

- Hydrophilic membrane
- For aqueous liquids and aqueous liquids with low organic contents
- Very low adsorption of pharmaceuticals and proteins
- Good stability against acids and bases
- Binding capacity for proteins 29 μg per 25 mm type filter

CHROMAFIL[®] Xtra

Type	Pore size [μm]	Effective membrane diameter [mm]		Standard pack Filters/pack	REF	BIGbox Filters/pack	REF
PES-20/25	0.20	22	labeled	100	729240	400	729240.400
PES-45/25	0.45	22	labeled	100	729241	400	729241.400
PES-500/25	5.0	22	labeled	100	729242		



Polyvinylidene difluoride (PVDF)



★ Key features

- Hydrophilic membrane
- For 100 % aqueous samples, water-soluble oligomers and polymers like proteins
- Binding capacity for proteins 20 µg per 25 mm filter type

CHROMAFIL® Xtra

Type	Pore size [µm]	Effective membrane diameter [mm]		Standard pack Filters/pack	REF	BIGbox Filters/pack	REF
PVDF-20/13	0.20	15.6	labeled	100	729243		
PVDF-45/13	0.45	15.6	labeled	100	729244		
PVDF-20/25	0.20	22	labeled	100	729218	400	729218.400
PVDF-45/25	0.45	22	labeled	100	729219	400	729219.400

CHROMAFIL®

Type	Pore size [µm]	Effective membrane diameter [mm]	Color code Top	Bottom	Standard pack Filters/pack	REF
PVDF-20/15 MS	0.20	15.6	yellow	white	100	729043
PVDF-45/15 MS	0.45	15.6	colorless	white	100	729044

MS = minispikes on filter exit

Glass fiber (GF)



★ Key features

- Inert filter, nominal pore size 1 µm, allows higher flow rates than small pore filters
- For solutions with high loads of particulate matter or for highly viscous solutions (e. g., soil samples, fermentation broths). Glass fiber exhibits a high protein-binding capacity.
- As prefilters for other CHROMAFIL® filters, they prevent plugging of the membrane

CHROMAFIL® Xtra

Type	Pore size [µm]	Effective membrane diameter [mm]		Standard pack Filters/pack	REF	BIGbox Filters/pack	REF
GF-100/13	nominal 1.0	15.6	labeled	100	729234		
GF-100/25	nominal 1.0	22	labeled	100	729228	400	729228.400

CHROMAFIL®

Type	Pore size [µm]	Effective membrane diameter [mm]	Color code Top	Bottom	Standard pack Filters/pack	REF	BIGbox Filters/Pack	REF
GF-100/15 MS	nominal 1.0	15.6	blue	colorless	100	729034		
GF-100/25	nominal 1.0	22	yellow	black	100	729028	400	729028.400

MS = minispikes on filter exit

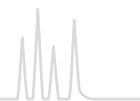

Special filter for ion chromatography (IC)



★ Key features

- For the filtration of aqueous liquids
- For optimal results with blind values < 5 ppb we recommend to prewash the filter with deionized water

CHROMAFIL[®] Xtra

Type	Pore size [µm]	Effective membrane diameter [mm]		Standard pack Filters/Pack	REF
IC-45/25	0.45	22	labeled	100	729258

Hints for using CHROMAFIL[®] syringe filters

For optimum filtration results we recommend to keep the following in mind:

- Either discard the first mL or rinse the filter unit with 1 mL of the solvent prior to filtration
- Before filling the syringe, draw about 1 mL air into the syringe in order to minimize the liquid remaining in the filter
- Start filtration with a slight pressure; this will optimize the throughput of the filter. As soon as particles accumulate on the filter, filtration will become more difficult and the pressure on the filter will increase.
- Change the filter whenever the resistance becomes too large in order to prevent rupture of the housing
- Do not apply CHROMAFIL[®] syringe filters on humans; they are only intended for lab use!
- Always use syringes ≥ 10 mL; smaller syringes can easily cause pressures above the 6 bar limit of the filters
- The temperature should not exceed 55 °C
- Do not re-use the filters

Disposable syringes with Luer tip



★ Key features

- Body and piston made from polypropylene (non sterile)

Volume	Pack of	REF
2 mL	100	729100
5 mL	100	729101
10 mL	100	729102



Chemical compatibility of filter materials

The chemical compatibility depends on several parameters such as time, pressure, temperature and concentration. In most cases, CHROMAFIL® filters will have only short contact with a solvent. In these cases they may be used despite of limited compatibility.

For example, a PTFE filter with PP housing does not liberate any UV-detectable substances during filtration of 5 mL THF, although PP shows only limited resistance towards THF.

The following table lists the chemical compatibility of our CHROMAFIL® materials.

Solvent	Material												
	MV	CA	RC	PA	PTFE	H-PTFE	PVDF	PES	PET	GF	IC	PP	
Acetaldehyde	-	-	+	○	+	+	+		+	+		○	
Acetic acid, 100 %	-	-	-	-	+	+	+	+	+	+		+	
Acetone	-	-	+	+	+	+	-	-	+	+		+	
Acetonitrile	-	-	+	+	+	+	+	+	+	+		+	
Ammonia, 25 %	-	-	○	-	+	+	+	+	○	+	-	+	
Benzene	+	+	+	+	+	+	○	+	+	+		○	
n-Butanol	+	+	+	○	+	+	+	+	+	+		+	
Cyclohexane	+	+	+	○	+	+	+	+	+	+		+	
Dichloromethane	+	-	+	-	+	+	+	-	+	+		-	
Diethyl ether	○	○	+	+	+	+	+	+	+	+		○	
Dimethylformamide	-	-	○	+	+	+	-	-	+	+		+	
1,4-Dioxane	-	-	+	+	+	+	○	-	+	+		○	
Ethanol	-	+	+	+	+	+	+	+	+	+		+	
Ethyl acetate	-	-	+	+	+	+	+	+	+	+		○	
Ethylene glycol	○	○	+	+	+	+	+	+	+	+		+	
Formic acid, 100 %	+	-	○	-	+	+	+	+	○	+		+	
Hydrochloric acid, 30 %	-	-	-	-	+	+	+	+	-	+	-	+	
Methanol	-	-	+	+	+	+	+	+	+	+		+	
Nitric acid, 65 %	-	-	-	-	○	+	○		○	+	-	-	
Oxalic acid, 10 % aqueous	+	-	+	-	+	+	+		+	+		+	
Petroleum ether	+	+	+	+	+	+	+	+	+	+		+	
Phosphoric acid, 80 %	-	-	○	-	+	+	○		+	+	-	+	
Potassium hydroxide, 1 mol/L	-	-	○	+	+	+	○	○	○	+	+	+	
2-Propanol	+	+	+	+	+	+	+	+	+	+		+	
Sodium hydroxide, 1 mol/L	-	-	○	+	+	+	○	○	○	○	+	+	
Tetrachloromethane	+	-	+	+	+	+	○		+	+		○	
Tetrahydrofuran	-	-	+	○	+	+	+	-	+	+		○	
Toluene	+	-	+	+	+	+	+	+	+	+		○	
Trichloroethene	+	+	+	○	+	+	+	○	+	+		○	
Trichloromethane (chloroform)	+	-	+	-	+	+	+	-	+	+		-	
Urea	+	+	+	+	+	+	+		+	+		+	
Water	+	+	+	+	+	+	+	+	+	+	+	+	
Xylene	+	+	+	+	+		○	○	+	+		○	

Data not guaranteed.

+ resistant, - not resistant, ○ limited resistance

Material

Membranes

MV = cellulose mixed esters, CA = cellulose acetate, RC = regenerated cellulose, PA = polyamide, PTFE = polytetrafluoroethylene, H-PTFE = hydrophilized polytetrafluoroethylene, PVDF = polyvinylidene difluoride, PES = polyethersulfone, PET = polyester, GF = glass fiber, IC = special filter for ion chromatography

Housing material

PP = polypropylene

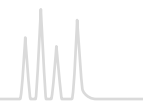

CHROMAFIL® filtration cartridges



★ Key features

- Filtration cartridges for sample clarification under vacuum (e.g., using the CHROMABOND 96-well plates vacuum manifold or SPE automation systems like Gilson ASPEC™, Rapidtrace®) or by gravity
- Cartridge sizes 3 mL and 6 mL
- Different membranes (PET, PTFE, GF) and pore sizes (0.2, 0.45 and 1.0 µm). Membrane materials correspond to the respective CHROMAFIL® syringe filters.

CHROMAFIL® filtration cartridges

Description	Pore size [µm]	Pack of [cartridges]	Column volume	
			3 mL	6 mL
Filtration cartridges PET (polyester)	0.20	100		730578.620
Filtration cartridges PET (polyester)	0.45	100		730578.645
Filtration cartridges PTFE (polytetrafluoroethylene)	0.20	100	730570.320	730570.620
Filtration cartridges PTFE (polytetrafluoroethylene)	0.45	100	730570.345	730570.645
Filtration cartridges GF (glass fiber)	nom. 1.0	100	730517.3100	730517.6100

CHROMAFIL® MULTI 96 filter plates



★ Key features

- 96-well polypropylene plates for the simultaneous filtration of 96 samples
- Advantages of this high-throughput system are:
- Economical by saving time and solvent
- The use of multi-channel pipettors facilitates liquid transfer steps
- Readily adaptable to all common automated and robotic handling systems
- Minimized dead volume (≤ 40 µL)
- Membrane materials correspond to the respective CHROMAFIL® syringe filters

CHROMAFIL® MULTI 96 Filter plates

Description	Pack of	REF
Filter plates with cellulose mixed ester filter elements (0.20 µm)	1	738770.M
Filter plates with cellulose mixed ester filter elements (0.45 µm)	1	738771.M
Filter plates with RC filter elements (regenerated cellulose 0.2 µm)	1	738656.M
Filter plates with RC filter elements (regenerated cellulose 0.45 µm)	1	738657.M
Filter plates with PTFE filter elements (0.2 µm)	1	738660.M
Filter plates with PTFE filter elements (0.45 µm)	1	738661.M
Filter plates with PTFE filter elements (3.0 µm)	1	738663.M
Filter plates with PE filter elements (40 – 100 µm)	1	738659.M
Filter plates with glass fiber filter elements (nominal 1 µm)	1	738655.2M
Filter plates with glass fiber filter elements (nominal 3 µm)	1	738658.M
CHROMABOND® MULTI 96 vacuum manifold for monoblocks, with reservoir tank, vacuum gauge and control valve, for filtration with 96-well filter plates	1	738630.M



MN Tip: High throughput (HTP) product solutions for solid phase extraction (SPE)

Solid phase extraction with
CHROMABOND[®] Multi 96 plates!



Find all CHROMABOND[®] Multi 96-well plates in our
Webshop!

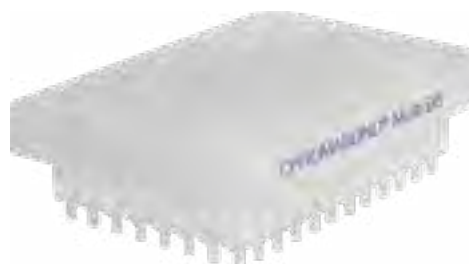



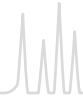

Contents

Basics.....	102
Crimp neck vials and caps N 8.....	106
Screw neck vials and caps N 8.....	107
Screw neck vials and caps N 9.....	109
Screw neck vials and caps N 10.....	113
Crimp neck vials and caps N 11.....	114
Snap ring vials and caps N 11.....	119
Crimp neck vials and caps N 13.....	123
Screw neck vials and caps N 13.....	124
Special vials and caps.....	125
Screw neck vials for storage of liquid samples.....	125
Snap cap vials for storage of powdery samples.....	128
Shell vials N 8.....	129
Screw neck vials / magnetic screw caps N 18.....	130
Crimp neck vials and caps N 20.....	132
Screw neck vials and caps N 24.....	137
Containers / Vial racks.....	139
Crimping tools.....	140

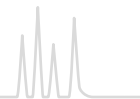

Technical data of vials

Except for the snap cap vials for storage of powdery samples and the blow-molded glass 70209.1, the vials of our program are made from 1st hydrolytic class glass. The dimensions stated in this catalog with respect to vial diameter and height are exact values. Please note that other suppliers often list rounded values (e.g., 12 × 32 mm instead of 11.6 × 32 mm), the actual dimensions are, however, identical due to the required fit in

Closure selection in GC/HPLC

The choice of the best closure depends on certain features of the instrument (needle type/design, transportation mechanism of the autosampler, etc.) as well as on the requirements of the application (temperature, sensitivity of the analysis, single/multiple injections, etc.) and thus is more complicated and more individual than selection of the correct vial type.

Basically the following recommendations can be made:

- Due to the relatively thick and blunt HPLC needles, only Silicone/PTFE closures, either with or without slit, should be used in combination with them.
- Screw closures N 9 are universally suitable on most autosamplers, convenient in handling and available in a broad selection of different cap colors and septa materials. They fulfill all requirements with regard to tightness and analytical purity for GC as well as for HPLC. Due to the relatively thin septa penetration is safe and easy. Crimp closures N 11 are also universally suitable with regard to autosampler compatibility, however, they are not as safe and convenient in their closing technique as the screw closures N 9.
- Snap ring closures N 11 should only be used in HPLC, as the punctual compacting pressure of the septum against the vial rim by the four pins in the cap does not achieve the same level of tightness as the evenly applied pressure through a circular thread or by crimping.
- For sensitive analyses only high purity Silicone/PTFE closures can be used; if additionally there is a need for minimal coring during penetration, a PTFE/Silicone/PTFE septum (sandwich septum) is recommendable.

the instrument. Our data concerning the volume are defined realistically usable volumes, not calculated values. For reasons of safety we state rather low values. Here, too, deviations of data of other suppliers may occur, which either use the calculated volume (e.g., 2 mL instead of 1.5 mL) or a defined, realistically usable volume in the upper range (e.g., 1.8 mL instead of 1.5 mL).

- Cap colors may be used for marking (sample marking/lab marking/shift marking). However, please consider that some autosamplers working with photocells may not be able to recognize transparent caps.
- For sample storage closed top screw closures (without center hole) should be used. Generally, these also need an elastomeric liner for sealing vials with liquid samples tightly.
- Due to their artificially reduced cap height screw caps N 9 don't have a standardized thread design. Therefore, it is recommendable only to use vials and closures from one source of supply, in order to ensure a harmonious and tight matching of both components.
- Replacement septa are partially available, however, in case of manual assembly you have the risk of contamination with skin fat/sweat and of a possible wrong side orientation. Therefore we highly recommend only to use ready assembled closures, where the liner perfectly matches the cap and has been automatically inserted under strict hygienic conditions.
- Normally ready assembled closures should be suitable for all types of needles, provided the proper type of septum has been selected. Nevertheless, there might be cases where usage of bonded closures (cap and liner form an inseparable unit) can be recommendable. Example: blunt HPLC needle, however, due to the risk of sample loss/concentration changes no septa with slit can be used. In order to avoid that the unslit septum is pushed into the vial by the needle, you use a bonded closure with unslit septum.
- The following table shows the different physical and chemical properties of the various elastomeric septa materials:



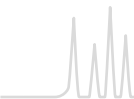

Septa Guide					
Septa material	Temperature resistance from / to	Analytical purity	Fragmentation due to hardness and molecular structure (coring)	Hardness (needle penetration)	Resealability (in case of multiple injections)
PTFE virginal	-200 °C / +260 °C	very high		very hard (but very thin material)	no resealability
Natural rubber / PTFE	-40 °C / +120 °C	low	high, big particles	very hard	high
Red Rubber / TEF (FEP)	-40 °C / +110 °C	medium	medium	medium hard	medium
Butyl	-40 °C / +120 °C	medium	medium	medium hard	medium
Butyl / PTFE	-40 °C / +120 °C	medium	medium	medium hard	medium
Silicone / PTFE	-60 °C / +200 °C	high	low to medium	soft	low to medium
PTFE / Silicone / PTFE	-60 °C / +200 °C	high	very low	soft	very low

Certificates

Upon request we can issue (batch related) certificates of conformity for all vials, inserts and closures, if this is required for your own ISO documentation.

Samples

Sample packs of all vials and closures can be requested at any time. The sample packs contain 5 pieces of the respective product. These can be requested cost-free with the REF number of the respective product plus the addition ".MUSTER" (e.g., 1 x 70201HP.MUSTER = 1 sample pack with five vials of 70201HP).



Example for a sample pack with five vials



Example for a sample pack with five screw closures

Packaging



Vials: normally packed with 100 pieces in a PP box, bottom part being shrink-wrapped



Closures: normally packed with 100 pieces in a resealable PE zip lock bag

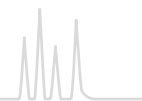

Literature

The following literature, which contains vials and caps, can be requested free of charge under the indicated KAT no.

Brochure vials and caps (English): KATEN200010

Link to the PDF download under: <https://www.mn-net.com/chromatography-downloads>



Chromatography catalog (English): KATEN200001

Link to the PDF download under: <https://www.mn-net.com/chromatography-downloads>



Brochure crimping tools (English): KATEN200100,
no longer available as hardcopy; only as a PDF download

Link to the PDF download under: <https://www.mn-net.com/chromatography-downloads>



Poster "Optimal crimping" (German/English): KATDE/EN200153

Link to the PDF download under: <https://www.mn-net.com/chromatography-downloads>



Translation tool for cross-references: the VialFinder at www.mn-net.com/vialfinder

The VialFinder is a database-driven translation tool for cross-references of instrument manufacturers and suppliers of consumables worldwide. The VialFinder immediately shows all options available from MACHEREY-NAGEL for the product of interest. The Finder shows 1:1 matches (in bold type) as well as possible alternative products (in normal type) that – in spite of technical differences to the indicated product – are suitable for the application. The corresponding link on the MN REF will lead you to the appropriate product page on our website that will give information on technical product features as well as possible illustrations of the product. In case you cannot find your part number via the VialFinder, please send your inquiry by e-mail to vials@mn-net.com providing us with all product information you may have. We will then check, if we can offer an equivalent product.

Website

The new website offers you support in many ways when searching for the optimal product for your application. Use the digital tools described below of our website in your daily laboratory work!

1. Search by product features:

Open the filter bar and select required individual product features from the drop-down menus. Applicable results are displayed to you in tile view.

2. Translation of cross-references:

Follow the link www.mn-net.com/vialfinder.

With the VialFinder part numbers of more than 60 consumables suppliers can be translated.

3. Product information:

Every product on the website has an extensive product detail page with technical data, some even with an additional "Learn more" tab with valuable background information. There is also a download area with relevant product literature.



4. Additional recommendations:

A selection of products with similar product characteristics, such as closures with the same septum, however, with different cap colors, is displayed on the product detail pages under the "Related Products" tab.

In contrast to that, the "Accessories" tab shows products that can be used in conjunction with the product you are looking for, such as vials that can be used in combination with a closure.

5. MN Information center at www.mn-net.com/chroma-news:

Stay up to date on product launches and interesting topics related to chromatography. Please kindly do so by studying the Chroma News, which provide exciting information. Tags make it easier to choose a topic.

6. Supporting videos under

<https://www.mn-net.com/e-training-chromatography>:

In the e-training section you will find videos that demonstrate practical and theoretical content in an illustrative way. For example, the principle of sample preparation using the so-called SPE is explained there or you can actively follow how to use electronic crimping tools.

7. Featured analytical topics:

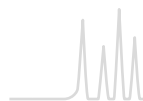

Under “Chromatography Service” you will find in the subsection “Featured topics” specific analytical applications, that are reported on in detail. There you also have access to our application database.

And finally: purchase our products fast and conveniently in our webshop – your exclusive shopping center.

Miscellaneous

Should you need more information concerning this product range, you can ask for our separate brochure “Vials and caps” (KATEN200010), which – among others – features 1:1 drawings of all glass products.

Except where explicitly mentioned, septa are assembled ready to use. Septa beneath or beside a cap are shown for illustration purposes only, and they are pictured upside down.

All drawings in this chapter are scale 1:2.

If you want to see how to use our website in an optimal way, watch the video by following this link:



General remarks

All information is subject to technical changes. All product data are subject to the currently valid specifications.

Contacts

Aside from your known contacts of our sales team you can also contact product management for technical questions at: vials@mn-net.com





Crimp neck vials and caps N 8

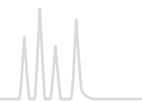

Crimp neck vials and caps N 8



★ Key features

- 0.2 – 0.3 mL usable volume
- Adapter required for use in an autosampler
- Available with round or conical bottom
- Economic closure version: Two-layer septum Red Rubber / FEP
- For more demanding analyses: high purity Silicone / PTFE septa

Crimp neck vials N 8

Illustrations scale 1:2

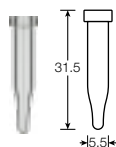

70286

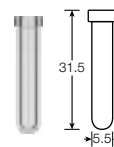

70282

Type of vial	Usable volume	OD × height	Pack of	REF
Clear, conical	0.2 mL	5.5 × 31.5 mm	100	70286
Clear, round bottom	0.3 mL	5.5 × 31.5 mm	100	70282

Ready assembled crimp closures N 8 and plain crimp caps N 8



702025



70289



702878



702800

Cap description	Septa description	Thickness	Pack of	REF
N 8 aluminum crimp cap, silver, center hole	Red Rubber / FEP colorless	1.0 mm	100	702025
N 8 aluminum crimp cap, silver, center hole	Silicone white / PTFE red	1.0 mm	100	70289
N 8 aluminum crimp cap, silver, center hole	PTFE red / Silicone white / PTFE red	1.0 mm	100	702878
N 8 aluminum crimp cap, silver, center hole	no liner	–	100	702800

Crimping tools N 8

Description	Pack of	REF
Manual crimper (standard) for 8 mm aluminum crimp caps	1	735126
Manual decapper (standard) for 8 mm aluminum crimp caps	1	735408
Manual ergonomic crimper for 8 mm aluminum crimp caps	1	735208



Manual crimper (standard)



Manual ergonomic crimper



Screw neck vials and caps N 8



★ Key features

- Are among the oldest vial types for HPLC and GC (besides crimp neck vials N 11)
- More and more replaced by screw neck vials N 9, which are easier to fill due to the wide opening compared to screw neck vials N 8 with small opening
- Due to the cap design not universally usable on all autosamplers in GC and HPLC – however, often used on instruments of VWR (Merck®) / Hitachi, Varian®, Knauer, Gilson®, Shimadzu® and others
- In combination with closed top screw closures also used for sample storage (see page 125)

Screw neck vials N 8, small opening (8-425 thread), and compatible inserts

Illustrations scale 1:2

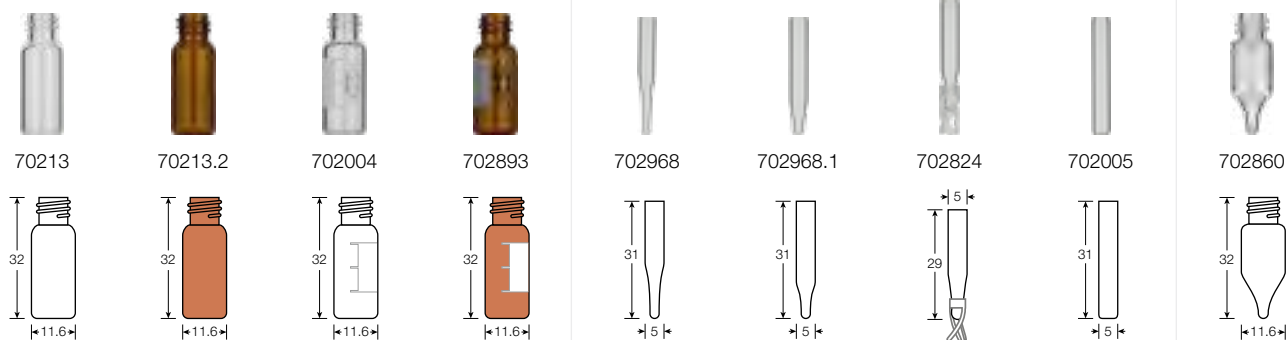

Type of vial	Usable volume	OD x height	Pack of	REF
Clear, flat bottom	1.5 mL	11.6 x 32 mm	100	70213
Amber, flat bottom	1.5 mL	11.6 x 32 mm	100	70213.2
Clear, flat bottom, label and scale	1.5 mL	11.6 x 32 mm	100	702004
Amber, flat bottom, label and scale	1.5 mL	11.6 x 32 mm	100	702893
Insert for small opening vials, clear, conical, 15 mm tip	0.1 mL	5 x 31 mm	100	702968
Insert for small opening vials, clear, conical, 9 mm tip	0.15 mL	5 x 31 mm	100	702968.1
Insert for small opening vials, clear, with plastic spring	0.1 mL	5 x 29 mm	100	702824
Insert for small opening vials, clear, flat bottom	0.25 mL	5 x 31 mm	100	702005
Micro-vial, clear, conical	1.1 mL	11.6 x 32 mm	100	702860



Screw neck vials and caps N 8

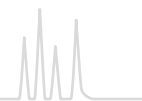

Ready assembled screw closures N 8 and plain screw caps N 8



702067



702068



70245



702066



702437



702069



70249



70250

Cap description	Septa description	Thickness	Pack of	REF
N 8 PP screw cap, black, center hole	Red Rubber / FEP colorless	1.3 mm	100	702067
as above, but with closed top	Red Rubber / FEP colorless	1.3 mm	100	702068
N 8 PP screw cap, black, center hole	Silicone white / PTFE red	1.3 mm	100	70245
as above, but with closed top	Silicone white / PTFE red	1.3 mm	100	702066
N 8 PP screw cap, black, center hole	Silicone white / PTFE blue, slit	1.0 mm	100	702437
N 8 PP screw cap, black, center hole	PTFE red / Silicone white / PTFE red	1.0 mm	100	702069
N 8 PP screw cap, black, center hole	no liner	–	100	70249
as above, but with closed top	no liner	–	100	70250

N 8 Septa for screw caps N 8

Material	Illustration	Thickness	Pack of	REF
Septum N 8, PTFE virginial, white		0.25 mm	100	70261
Septum N 8, Red Rubber / FEP colorless		1.3 mm	100	702070
Septum N 8, Silicone white / PTFE red		1.3 mm	100	70248
Septum N 8, Silicone white / PTFE blue, slit		1.0 mm	100	702481



Finding instead of searching:

Translation of cross-references with the VialFinder

Are you in need to change your current vials and caps supplier due to quality, price or delivery issues? Make an easy changeover to vials and caps from MACHEREY-NAGEL by using our VialFinder – a database driven tool on our website that can help you with the translation of cross-references of vials and caps products from suppliers from all over the world. This powerful and easy-to-use tool has been updated, so that you now find cross-references from almost 60 suppliers worldwide (instrument companies and consumables suppliers).



www.mn-net.com/vialfinder



Screw neck vials and caps N 9



★ Key features

- Can be used on almost all HPLC and GC autosamplers
- Large range of vials and closures
- Also available as bonded closures (advantage: thick (blunt) HPLC needles cannot push the septum into the vial)
- Also available as pre-sealed vial-closure combinations
- 1.5 mL polypropylene vials N 9 for special applications (e.g., IC, CE, PFAS, etc.)

Screw neck vials N 9, wide opening (short thread), and compatible inserts

Illustrations scale 1:2

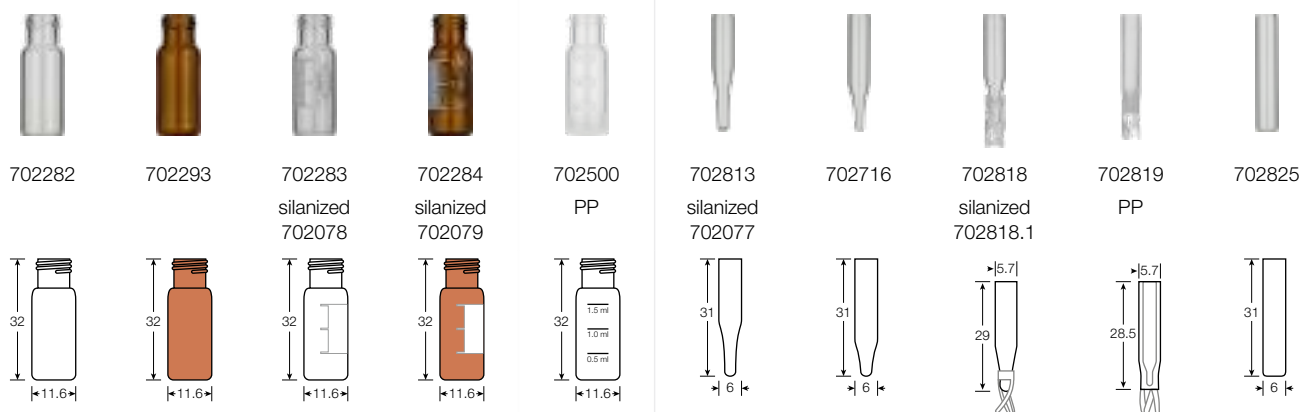

Type of vial	Usable volume	OD × height	Pack of	REF
Clear, flat bottom	1.5 mL	11.6 × 32 mm	100	702282
Amber, flat bottom	1.5 mL	11.6 × 32 mm	100	702293
Clear, flat bottom, label and scale	1.5 mL	11.6 × 32 mm	100	702283
as above, silanized	1.5 mL	11.6 × 32 mm	100	702078
Amber, flat bottom, label and scale	1.5 mL	11.6 × 32 mm	100	702284
as above, silanized	1.5 mL	11.6 × 32 mm	100	702079
Polypropylene, transparent, with filling lines	1.5 mL	11.6 × 32 mm	100	702500
Insert for wide opening vials, clear, conical, 15 mm tip	0.2 mL	6 × 31 mm	100	702813
as above, silanized	0.2 mL	6 × 31 mm	100	702077
Insert for wide opening vials, clear, conical, 12 mm tip	0.25 mL	6 × 31 mm	100	702716
Insert for wide opening vials, clear, with plastic spring	0.1 mL	5.7 × 29 mm	100	702818
as above, silanized	0.1 mL	5.7 × 29 mm	100	702818.1
PP Insert for wide opening vials, transparent, with integrated spring	0.1 mL	5.7 × 29 mm	100	702819
Insert for wide opening vials, clear, flat bottom	0.3 mL	6 × 31 mm	100	702825



Screw neck vials and caps N 9

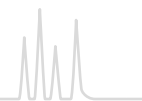

Screw neck micro-vials N 9, wide opening (short thread)

Illustrations scale 1:2



Type of vial	Usable volume	OD x height	Pack of	REF
Micro-vial, clear, 15 µL funnel in solid glass bottom	1.1 mL	11.6 x 32 mm	100	702006
Micro-vial, clear, conical, with round pedestal glass plate	1.1 mL	11.6 x 32 mm	100	702088
Micro-vial, clear, with integrated 0.2 mL insert	0.2 mL	11.6 x 32 mm	100	702007
Micro-vial, amber, with integrated 0.2 mL insert	0.2 mL	11.6 x 32 mm	100	702008
Micro-vial, polypropylene, transparent, with integrated 0.2 mL glass insert, conical	0.2 mL	11.6 x 32 mm	100	702135*
Micro-vial, polypropylene, amber, with integrated 0.2 mL glass insert, conical	0.2 mL	11.6 x 32 mm	100	702335*
Micro-vial, polypropylene, transparent, with inner cone	0.3 mL	11.6 x 32 mm	100	702009
Micro-vial, polypropylene, amber, with inner cone	0.3 mL	11.6 x 32 mm	100	702172
Micro-vial, polypropylene, transparent, with round bottom insert	0.7 mL	11.6 x 32 mm	100	702010

* upon request also available with an integrated silanized glass insert

Pre-assembled vial-insert combinations with screw neck N 9

Vial description	Insert description	Pack of	REF
Vial 702282: 1.5 mL, clear, flat bottom	with pre-assembled micro-insert 702813: 0.2 mL, conical, 15 mm tip	100	702177
Vial 702283: 1.5 mL, clear, flat bottom, label and scale	with pre-assembled micro-insert 702813: 0.2 mL, conical, 15 mm tip	100	702178
Vial 702284: 1.5 mL, amber, flat bottom, label and scale	with pre-assembled micro-insert 702813: 0.2 mL, conical, 15 mm tip	100	702179

Further pre-assembled vial-insert combinations on request

Bonded screw closures N 9 (septum firmly connected with the cap; cannot be removed)



Cap description	Septa description	Thickness	Pack of	REF
N 9 PP bonded screw cap, blue, center hole	Red Rubber / TEF colorless	1.0 mm	100	702028
N 9 PP bonded screw cap, blue, center hole	Silicone beige / PTFE white	1.3 mm	100	702026
N 9 PP bonded screw cap, blue, center hole	Silicone beige / PTFE white, slit	1.3 mm	100	702027

Screw neck vials and caps N 9



Ready assembled screw closures N 9



Cap description	Septa description	Thickness	Pack of	REF
N 9 PP screw cap, transparent, center hole	PTFE virginal, white	0.25 mm	100	702029
N 9 PP screw cap, blue, center hole	PTFE virginal, white	0.25 mm	100	702031
N 9 PP screw cap blue, closed top	PTFE virginal, white	0.25 mm	100	702032



Cap description	Septa description	Thickness	Pack of	REF
N 9 PP screw cap, transparent, center hole	Red Rubber / FEP colorless	1.0 mm	100	702030
N 9 PP screw cap, blue, center hole	Red Rubber / FEP colorless	1.0 mm	100	702732
N 9 PP screw cap, black, center hole	Red Rubber / FEP colorless	1.0 mm	100	702080
N 9 PP screw cap, red, center hole	Red Rubber / FEP colorless	1.0 mm	100	702081
N 9 PP screw cap, green, center hole	Red Rubber / FEP colorless	1.0 mm	100	702082
N 9 PP screw cap, yellow, center hole	Red Rubber / FEP colorless	1.0 mm	100	702147
N 9 PP screw cap blue, closed top	Red Rubber / FEP colorless	1.0 mm	100	702033



Cap description	Septa description	Thickness	Pack of	REF
N 9 PP screw cap, transparent, center hole	Silicone white / PTFE red	1.0 mm	100	702287
N 9 PP screw cap, blue, center hole	Silicone white / PTFE red	1.0 mm	100	702287.1
N 9 PP screw cap, black, center hole	Silicone white / PTFE red	1.0 mm	100	702036
N 9 PP screw cap, red, center hole	Silicone white / PTFE red	1.0 mm	100	702037
N 9 PP screw cap, green, center hole	Silicone white / PTFE red	1.0 mm	100	702038
N 9 PP screw cap, yellow, center hole	Silicone white / PTFE red	1.0 mm	100	702107
N 9 magnetic screw cap, silver, center hole	Silicone white / PTFE red	1.0 mm	100	702155
N 9 PP screw cap, blue, center hole	Silicone white / Polyimide orange, fluorine-free	1.0 mm	100	702402
N 9 PP screw cap blue, closed top	Silicone white / PTFE red	1.0 mm	100	702034

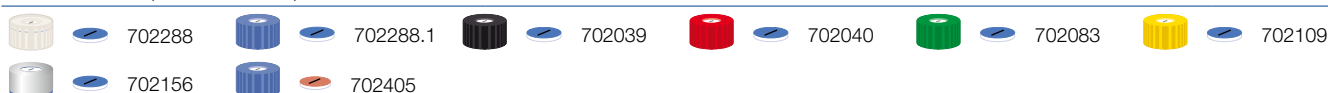

Cap description	Septa description	Thickness	Pack of	REF
N 9 PP screw cap, transparent, center hole	Silicone white / PTFE blue, slit	1.0 mm	100	702288
N 9 PP screw cap, blue, center hole	Silicone white / PTFE blue, slit	1.0 mm	100	702288.1
N 9 PP screw cap, black, center hole	Silicone white / PTFE blue, slit	1.0 mm	100	702039
N 9 PP screw cap, red, center hole	Silicone white / PTFE blue, slit	1.0 mm	100	702040
N 9 PP screw cap, green, center hole	Silicone white / PTFE blue, slit	1.0 mm	100	702083
N 9 PP screw cap, yellow, center hole	Silicone white / PTFE blue, slit	1.0 mm	100	702109
N 9 magnetic screw cap, silver, center hole	Silicone white / PTFE blue, slit	1.0 mm	100	702156
N 9 PP screw cap, blue, center hole	Silicone white / Polyimide orange, slit, fluorine-free	1.0 mm	100	702405



Screw neck vials and caps N 9

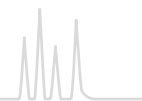

Ready assembled screw closures N 9

Cap description	Septa description	Thickness	Pack of	REF	
702286	702035	702158	702084	702085	702159
N 9 PP screw cap, transparent, center hole	PTFE red / Silicone white / PTFE red	1.0 mm	100	702286	
N 9 PP screw cap, blue, center hole	PTFE red / Silicone white / PTFE red	1.0 mm	100	702035	
N 9 PP screw cap, black, center hole	PTFE red / Silicone white / PTFE red	1.0 mm	100	702158	
N 9 PP screw cap, red, center hole	PTFE red / Silicone white / PTFE red	1.0 mm	100	702084	
N 9 PP screw cap, green, center hole	PTFE red / Silicone white / PTFE red	1.0 mm	100	702085	
N 9 PP screw cap, yellow, center hole	PTFE red / Silicone white / PTFE red	1.0 mm	100	702159	
702160	702161	702162	702163	702164	702165
N 9 PP screw cap, transparent, center hole	no liner	–	100	702160	
N 9 PP screw cap, blue, center hole	no liner	–	100	702161	
N 9 PP screw cap, black, center hole	no liner	–	100	702162	
N 9 PP screw cap, red, center hole	no liner	–	100	702163	
N 9 PP screw cap, green, center hole	no liner	–	100	702164	
N 9 PP screw cap, yellow, center hole	no liner	–	100	702165	

N 9 septa for screw caps N 9

Material	Illustration	Thickness	Pack of	REF
PTFE virginal, white		0.25 mm	100	702043
Red Rubber / FEP colorless		1.0 mm	100	702041
Silicone white / PTFE red		1.0 mm	100	702042
Silicone white / PTFE blue, slit		1.0 mm	100	702148



Pre-sealed vial-closure combination

Pre-sealed vial-closure combinations with screw neck N 9

Vial description	Closure description	Pack of	REF
Pre-sealed vials 702282: 1.5 mL screw neck vial N 9, 11.6 × 32 mm, clear, flat bottom, wide opening	pre-screwed with 702732: N 9 PP screw cap, blue, center hole, Red Rubber/FEP colorless, 1.0 mm	100	702857
Pre-sealed vials 702283: 1.5 mL screw neck vial N 9, 11.6 × 32 mm, clear, flat bottom, wide opening, label and scale	pre-screwed with 702732: N 9 PP screw cap, blue, center hole, Red Rubber/FEP colorless, 1.0 mm	100	702858
Pre-sealed vials 702282: 1.5 mL screw neck vial N 9, 11.6 × 32 mm, clear, flat bottom, wide opening	pre-screwed with 702287.1: N 9 PP screw cap, blue, center hole, Silicone white/PTFE red, 1.0 mm	100	702874
Pre-sealed vials 702283: 1.5 mL screw neck vial N 9, 11.6 × 32 mm, clear, flat bottom, wide opening, label and scale	pre-screwed with 702288.1: N 9 PP screw cap, blue, center hole, Silicone white/PTFE blue, slit, 1.0 mm	100	702863
Pre-sealed vials 702284: 1.5 mL screw neck vial N 9, 11.6 × 32 mm, amber, flat bottom, wide opening, label and scale	pre-screwed with 702288.1: N 9 PP screw cap, blue, center hole, Silicone white/PTFE blue, slit, 1.0 mm	100	702873
Pre-sealed vials 702283: 1.5 mL screw neck vial N 9, 11.6 × 32 mm, clear, flat bottom, wide opening, label and scale	pre-screwed with 702026: N 9 PP bonded screw cap, blue, center hole, Silicone beige / PTFE white, 1.3 mm	100	702864

Other pre-sealed vial-closure combinations on request.

Screw neck vials and caps N 10



Screw neck vials and caps N 10



★ Key features

- Wide opening for easy filling
- Due to the cap height not universally suitable for all instruments
- Often used on Jasco, Shimadzu® and PerkinElmer® instruments
- Large range of bonded screw closures for a safe penetration (septa firmly connected with the cap; cannot be removed)

Screw neck vials N 10, wide opening (10-425 thread), and compatible inserts

Illustrations scale 1:2

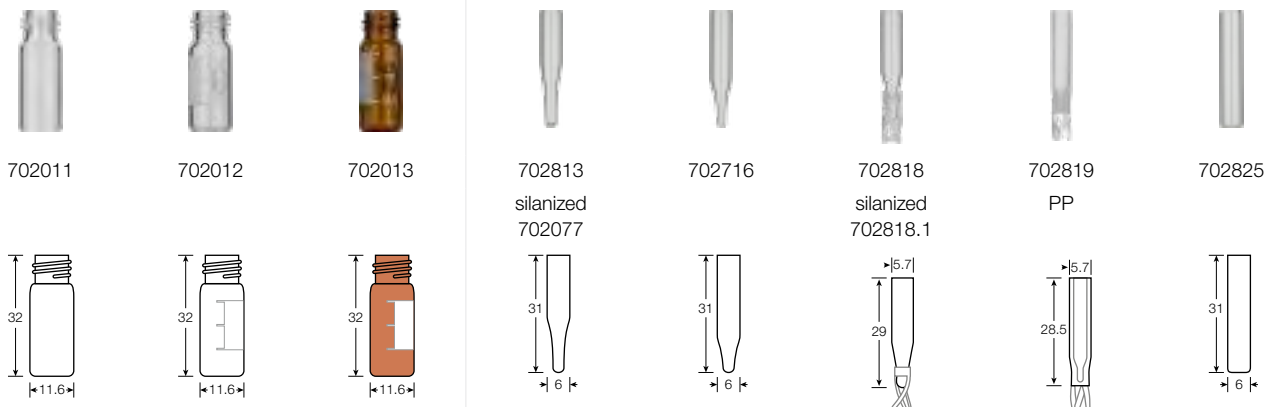

Type of vial	Usable volume	OD × height	Pack of	REF
Clear, flat bottom	1.5 mL	11.6 × 32 mm	100	702011
Clear, flat bottom, label and scale	1.5 mL	11.6 × 32 mm	100	702012
Amber, flat bottom, label and scale	1.5 mL	11.6 × 32 mm	100	702013
Insert for wide opening vials, clear, conical, 15 mm tip	0.2 mL	6 × 31 mm	100	702813
as above, silanized	0.2 mL	6 × 31 mm	100	702077
Insert for wide opening vials, clear, conical, 12 mm tip	0.25 mL	6 × 31 mm	100	702716
Insert for wide opening vials, clear, with plastic spring	0.1 mL	5.7 × 29 mm	100	702818
as above, silanized	0.1 mL	5.7 × 29 mm	100	702818.1
PP insert for wide opening vials, transparent, with integrated spring	0.1 mL	5.7 × 29 mm	100	702819
Insert for wide opening vials, clear, flat bottom	0.3 mL	6 × 31 mm	100	702825

Screw closures N 10 and plain screw caps N 10



Cap description	Septa description	Thickness	Pack of	REF
N 10 PP bonded screw cap*, black, center hole	Red Rubber / TEF colorless	1.0 mm	100	702044
N 10 PP bonded screw cap*, black, center hole	Silicone white / PTFE beige	1.5 mm	100	702045
N 10 PP bonded screw cap*, black, center hole	Silicone white / PTFE red	1.0 mm	100	702046
N 10 PP bonded screw cap*, black, center hole	Silicone white / PTFE blue, slit	1.5 mm	100	702047
N 10 PP screw cap, black, center hole	PTFE red / Silicone white / PTFE red	1.0 mm	100	702048
N 10 PP screw cap, black, center hole	no liner	–	100	702049

* Septum firmly connected with the cap, cannot be removed.



Crimp neck vials and caps N 11

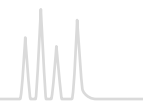

Crimp neck vials and caps N 11

★ Key features



- Broad variety of standard crimp neck vials (with small or wide opening), as well as crimp neck micro-vials for smaller sample volumes
- Economic closures: Natural rubber / TEF (2 layers), Natural rubber / Butyl / TEF (3 layers) and Red Rubber / FEP (2 layers)
- For more demanding analyses: analytically pure Silicone / PTFE septa with lower fragmentation
- Magnetic closure: REF 702879 for use on CTC GC PAL
- Manual and electronic crimping tools for vials N 11 can be found on pages 118 and 140 – 141.

Crimp neck vials N 11, small opening, and compatible inserts

Illustrations scale 1:2

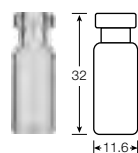

70201CG

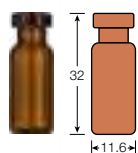

70214CG

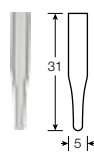

702968

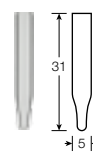

702968.1

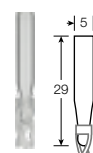

702824

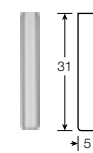

702005

Type of vial	Usable volume	OD × height	Pack of	REF
Clear, flat bottom, small opening	1.5 mL	11.6 × 32 mm	100	70201CG
Amber, flat bottom, small opening	1.5 mL	11.6 × 32 mm	100	70214CG
Insert for small opening vials, clear, conical, 15 mm tip	0.1 mL	5 × 31 mm	100	702968
Insert for small opening vials, clear, conical, 9 mm tip	0.15 mL	5 × 31 mm	100	702968.1
Insert for small opening vials, clear, with plastic spring	0.1 mL	5 × 29 mm	100	702824
Insert for small opening vials, clear, flat bottom	0.25 mL	5 × 31 mm	100	702005



Vials and caps for PFAS analysis

Per- and polyfluoroalkyl substances (PFAS) are used for many daily applications, e.g. food packaging and textile coating, because of their non-sticky properties. However, most PFAS are dangerous substances that need to be monitored globally. Due to their increasing appearance in the environment, new product solutions for their analysis are of great demand.

When you are doing PFAS analysis, it is crucial to select the right vials and closures for this application. Adsorption effects of glass as well as possible contaminations of the sample by particles from the septa, especially from the PTFE lamination, may put your analysis results at risk.

Polypropylene vials are best suited for PFAS analysis, since the adsorption effects are the lowest and the signal strength of the analytes is therefore the highest. Fluorine-free septa, i. e. septa with a polyimide coating rather than a PTFE coating, are recommended to eliminate any migration of fluorine into the sample.





Crimp neck vials N 11, wide opening, and compatible inserts

Illustrations scale 1:2

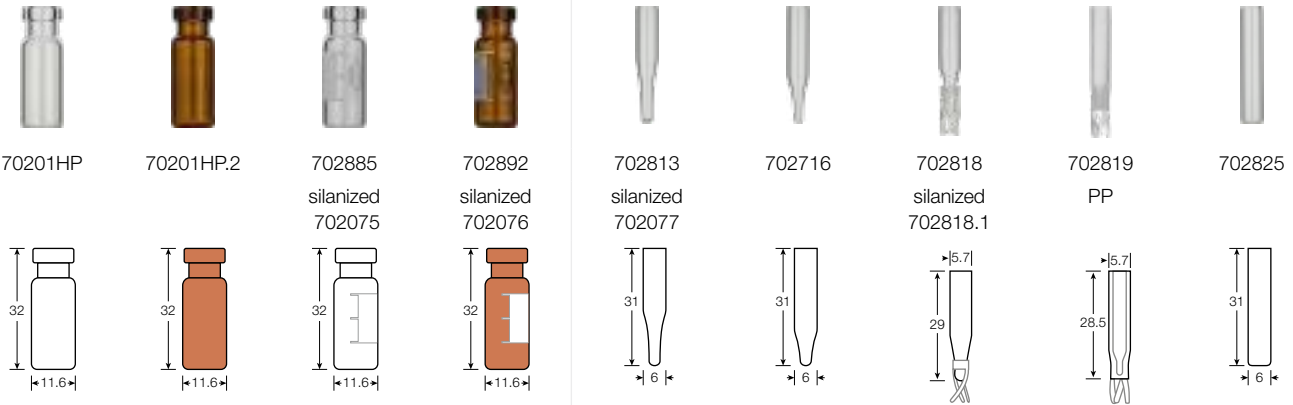

Type of vial	Usable volume	OD × height	Pack of	REF
Clear, flat bottom, wide opening	1.5 mL	11.6 × 32 mm	100	70201HP
Amber, flat bottom, wide opening	1.5 mL	11.6 × 32 mm	100	70201HP.2
Clear, flat bottom, wide opening, label and scale	1.5 mL	11.6 × 32 mm	100	702885
as above, silanized	1.5 mL	11.6 × 32 mm	100	702075
Amber, flat bottom, wide opening, label and scale	1.5 mL	11.6 × 32 mm	100	702892
as above, silanized	1.5 mL	11.6 × 32 mm	100	702076
Insert for wide opening vials, clear, conical, 15 mm tip	0.2 mL	6 × 31 mm	100	702813
as above, silanized	0.2 mL	6 × 31 mm	100	702077
Insert for wide opening vials, clear, conical, 12 mm tip	0.25 mL	6 × 31 mm	100	702716
Insert for wide opening vials, clear, with plastic spring	0.1 mL	5.7 × 29 mm	100	702818
as above, silanized	0.1 mL	5.7 × 29 mm	100	702818.1
PP Insert for wide opening vials, transparent, with integrated spring	0.1 mL	5.7 × 29 mm	100	702819
Insert for wide opening vials, clear, flat bottom	0.3 mL	6 × 31 mm	100	702825



Optimal crimping

For an optimal crimp result the crimping tool needs to be adjusted to:

- Type and height of the vial's crimp neck
- Thickness and hardness of the septa
- Properties of the cap (type, material)

For doing so, please refer to the instruction manual of the individual tool.

Permanent control of the crimp result and thus of the crimping tool settings is necessary.

Incorrect crimping can be recognized by the following features:



Cap deformation



Pulled up edge of the center hole



Strong formation of wrinkles



Convex looking liner



Cap can be turned with only low expenditure of power



Crimp neck vials and caps N 11

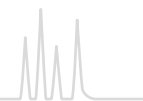

Crimp neck micro-vials N 11

Illustrations scale 1:2

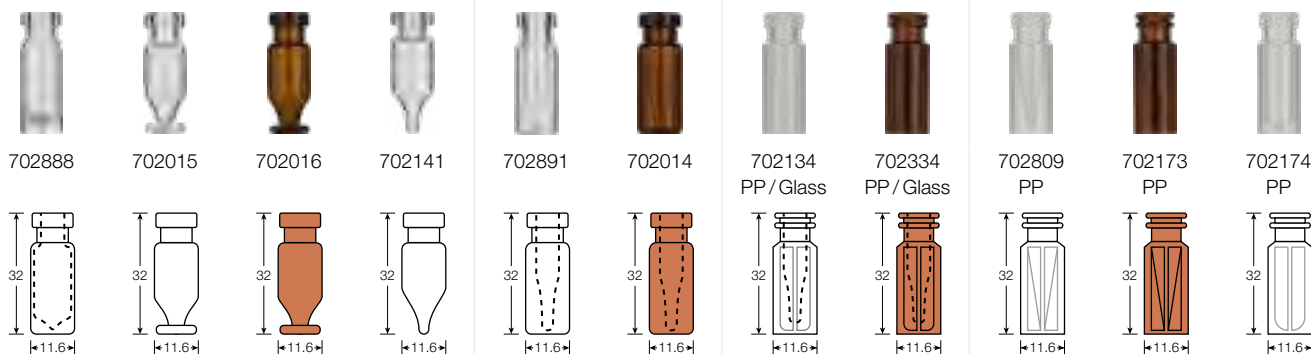

Type of vial	Usable volume	OD × height	Pack of	REF
Micro-vial, clear, flat bottom 15 µL funnel in solid glass bottom	1.1 mL	11.6 × 32 mm	100	702888
Micro-vial, clear, conical, with round pedestal glass plate	1.1 mL	11.6 × 32 mm	100	702015
Micro-vial, amber, conical, with round pedestal glass plate	1.1 mL	11.6 × 32 mm	100	702016
Micro-vial, clear, conical	1.1 mL	11.6 × 32 mm	100	702141
Micro-vial, clear, with integrated 0.2 mL insert	0.2 mL	11.6 × 32 mm	100	702891
Micro-vial, amber, with integrated 0.2 mL insert	0.2 mL	11.6 × 32 mm	100	702014
Micro-vial, polypropylene, transparent, with integrated 0.2 mL glass insert, conical	0.2 mL	11.6 × 32 mm	100	702134*
Micro-vial, polypropylene, amber, with integrated 0.2 mL glass insert, conical	0.2 mL	11.6 × 32 mm	100	702334*
Micro-vial, polypropylene, transparent, with inner cone	0.3 mL	11.6 × 32 mm	100	702809
Micro-vial, polypropylene, amber, with inner cone	0.3 mL	11.6 × 32 mm	100	702173
Micro-vial, polypropylene, transparent, with round bottom insert	0.7 mL	11.6 × 32 mm	100	702174

* upon request also available with an integrated silanized glass insert

Ready assembled aluminum crimp closures N 11

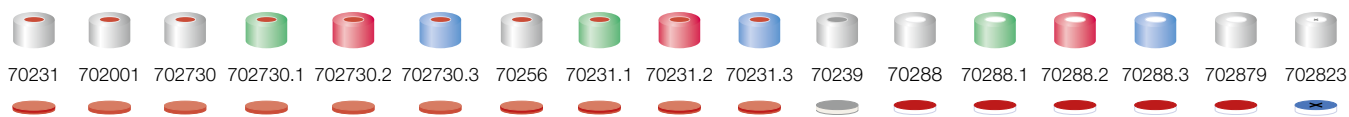

Cap description	Septa description	Thickness	Pack of	REF
N 11 aluminum crimp cap, silver, center hole	Natural rubber / Butyl red-orange / TEF colorless	1.3 mm	100	70231
N 11 aluminum crimp cap, silver, center hole	Natural rubber red-orange / TEF colorless	1.0 mm	100	702001
N 11 aluminum crimp cap, silver, center hole	Red Rubber / FEP colorless	1.0 mm	100	702730
N 11 aluminum crimp cap, green, center hole	as above	1.0 mm	100	702730.1
N 11 aluminum crimp cap, red, center hole	as above	1.0 mm	100	702730.2
N 11 aluminum crimp cap, blue, center hole	as above	1.0 mm	100	702730.3
N 11 aluminum crimp cap, silver, center hole	Natural rubber / Butyl red-orange / TEF colorless	1.0 mm	100	70256
N 11 aluminum crimp cap, green, center hole	as above	1.0 mm	100	70231.1
N 11 aluminum crimp cap, red, center hole	as above	1.0 mm	100	70231.2
N 11 aluminium crimp cap, blue, center hole	as above	1.0 mm	100	70231.3
N 11 aluminum crimp cap, silver, center hole	PTFE gray / Butyl beige / PTFE gray	1.3 mm	100	70239
N 11 aluminum crimp cap, silver, center hole	Silicone white / PTFE red	1.3 mm	100	70288
N 11 aluminum crimp cap, green, center hole	as above	1.3 mm	100	70288.1
N 11 aluminum crimp cap, red, center hole	as above	1.3 mm	100	70288.2
N 11 aluminum crimp cap, blue, center hole	as above	1.3 mm	100	70288.3
N 11 magnetic crimp cap, silver, center hole	Silicone white / PTFE red	1.0 mm	100	702879
N 11 aluminum crimp cap, silver, center hole	Silicone white / PTFE blue, cross-slit	1.5 mm	100	702823*
N 11 PE cap, transparent, closed top, with thin piercing area			100	702401

* upon request also available with a green, red or a blue crimp cap

Crimp neck vials and caps N 11



Ready assembled crimp closures N 11



Cap description	Septa description	Thickness	Pack of	REF
N 11 aluminum crimp cap, silver, center hole	PTFE red / Silicone white / PTFE red	1.0 mm	100	702995
N 11 aluminum crimp cap, green, center hole	as above	1.0 mm	100	702995.1
N 11 aluminum crimp cap, red, center hole	as above	1.0 mm	100	702995.2
N 11 aluminum crimp cap, blue, center hole	as above	1.0 mm	100	702995.3
N 11 aluminum crimp cap, silver, center hole	PTFE virginal, white	0.25 mm	100	70284
N 11 aluminum crimp cap, silver, roll groove, center hole	O-ring + aluminium septa, TPF (Total Phthalate Free)	0.1 mm	100	702175
N 11 aluminum crimp cap, silver, center hole	no liner	-	100	702801

Pre-sealed vial-closure combinations with crimp neck N 11

Vial description	Closure description	Pack of	REF
Pre-sealed vials 70201HP: 1.5 mL crimp neck vial N 11, 11.6 × 32 mm, clear, flat bottom, wide opening	crimped with 70256: N 11 aluminum crimp cap, silver, center hole, Natural rubber / Butyl red-orange / TEF colorless, 1.0 mm	100	702101HP
Pre-sealed vials 702892: 1.5 mL crimp neck vial N 11, 11.6 × 32 mm, amber, flat bottom, wide opening, label and scale	crimped with 70256: N 11 aluminum crimp cap, silver, center hole, Natural rubber / Butyl red-orange / TEF colorless, 1.0 mm	100	702859
Pre-sealed vials 70201HP: 1.5 mL crimp neck vial N 11, 11.6 × 32 mm, clear, flat bottom, wide opening	crimped with 702995: N 11 aluminum crimp cap, silver, center hole, PTFE red / Silicone white / PTFE red, 1.0 mm	100	702867
Pre-sealed vials 70201CG: 1.5 mL crimp neck vial N 11, 11.6 × 32 mm, clear, flat bottom, small opening	crimped with 70231: N 11 aluminum crimp cap, silver, center hole, Natural rubber / Butyl red-orange / TEF colorless, 1.3 mm	100	702882
Pre-sealed vials 70201HP: 1.5 mL crimp neck vial N 11, 11.6 × 32 mm, clear, flat bottom, wide opening	crimped with 702823: N 11 aluminum crimp cap, silver, center hole, Silicone white / PTFE blue, cross-slit, 1.5 mm	100	702887
Pre-sealed vials 702892: 1.5 mL crimp neck vial N 11, 11.6 × 32 mm, amber, flat bottom, wide opening, label +scale	crimped with 702823: N 11 aluminum crimp cap, silver, center hole, Silicone white / PTFE blue, cross-slit, 1.5 mm	100	702895

Other pre-sealed vial-closure combinations on request

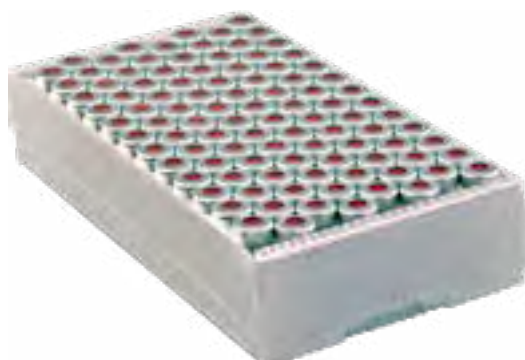

Pre-sealed vial-closure combination



Crimp neck vials and caps N 11

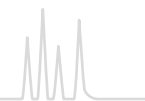

Crimping tools N 11

Description	Pack of	REF
Manual crimper (standard), height adjustable, for 11 mm aluminum crimp caps	1	735111
Manual decapper (standard) for 11 mm aluminum crimp caps	1	735911
Manual ergonomic crimper for 11 mm aluminum crimp caps	1	735211
Manual ergonomic decapper for 11 mm aluminum crimp caps	1	735311
Electronic crimper for 11 mm aluminum crimp caps (battery-powered)	1	735511
Electronic decapper for 11 mm aluminum crimp caps (battery-powered)	1	735611
Electronic high power crimping tool with power supply	1	735700
Crimping head for 11 mm crimp caps (aluminum, magnetic)	1	735711
Decapping head for 11 mm crimp caps (aluminum, magnetic)	1	735811
Stand for electronic crimping tools	1	735501
Replacement battery 6.6 V, 8.6 Wh for 735511, 735611	1	735500
Rack for two crimping tools either type ergonomic (manual) or electronic, blue, 240 x 95 x 65 mm	1	735509



Manual crimper
Standard



Manual crimper
Ergonomic



Electronic crimper
Battery-powered

To see the electronic, battery-powered tool in operation, watch the video under the following link:



Useful tips for optimal crimping

can be found on our website under www.mn-net.com/media/pdf/Poster-Optimal-Crimping-EN.pdf .

As a decision-making aid when choosing the most suitable crimping tool for your personal needs, use our specialized brochure "Crimping tools", which you can find in the chromatography download area at www.mn-net.com/chromatography-downloads on our website.

To find out about the different operation modes of the various crimping tool types, please click on the tab "Learn more" on the product detail page of each crimping tool on our website.





Snap ring vials and caps N 11



Snap ring vials and caps N 11



★ Key features

- Quick, convenient sealing method which, however, should only be used in HPLC
- Can be used on all common HPLC autosamplers
- Alternatively crimp closures N 11 can be used (see preceding pages).
- 0.3 and 0.7 mL PP snap ring vials for special applications, e.g., for ion chromatography
- Most common closure: with cross-slit Silicone / PTFE septum, which supports easy penetration with the relatively thick, blunt HPLC needles
- Besides hard caps also more easy to handle soft caps in light blue are available

Snap ring vials N 11, wide opening, and compatible inserts

Illustrations scale 1:2

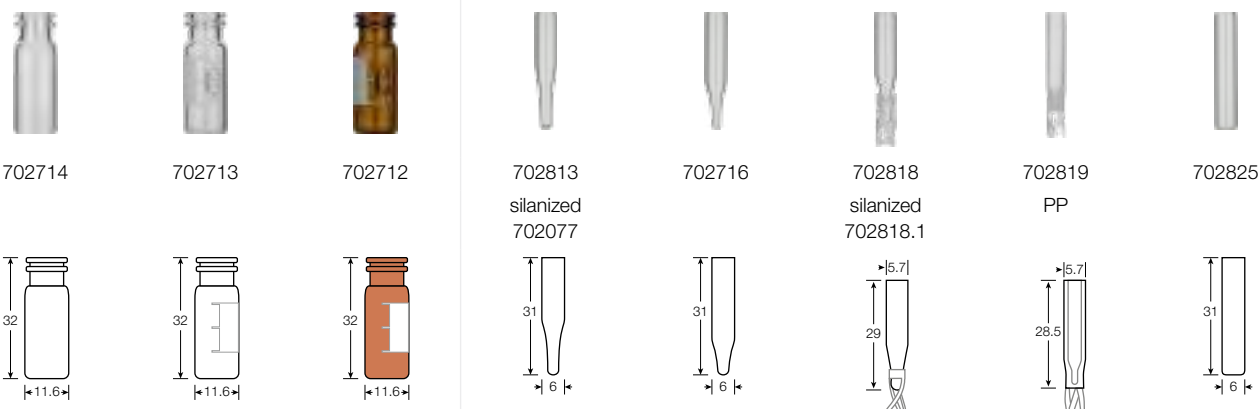

Type of vial	Usable volume	OD × height	Pack of	REF
Clear, flat bottom	1.5 mL	11.6 × 32 mm	100	702714
Clear, flat bottom, label and scale	1.5 mL	11.6 × 32 mm	100	702713
Amber, flat bottom, label and scale	1.5 mL	11.6 × 32 mm	100	702712
Insert for wide opening vials, clear, conical, 15 mm tip	0.2 mL	6 × 31 mm	100	702813
as above, silanized	0.2 mL	6 × 31 mm	100	702077
Insert for wide opening vials, clear, conical, 12 mm tip	0.25 mL	6 × 31 mm	100	702716
Insert for wide opening vials, clear, with plastic spring	0.1 mL	5.7 × 29 mm	100	702818
as above, silanized	0.1 mL	5.7 × 29 mm	100	702818.1
PP Insert for wide opening vials, transparent, with integrated spring	0.1 mL	5.7 × 29 mm	100	702819
Insert for wide opening vials, clear, flat bottom	0.3 mL	6 × 31 mm	100	702825



Snap ring vials and caps N 11

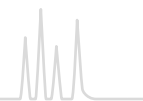

Snap ring micro-vials N 11, wide opening

Illustrations scale 1:2

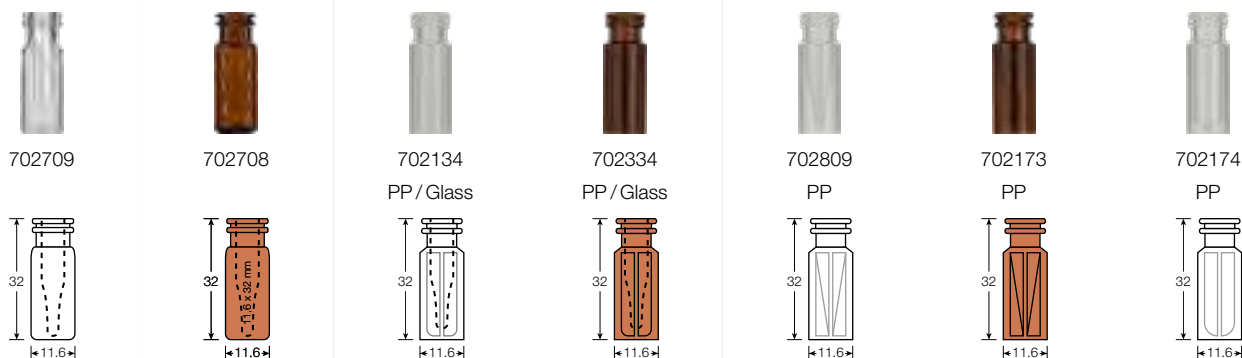

Type of vial	Usable volume	OD x height	Pack of	REF
Micro-vial, clear, with integrated 0.2 mL insert	0.2 mL	11.6 x 32 mm	100	702709
Micro-vial, amber, with integrated 0.2 mL insert	0.2 mL	11.6 x 32 mm	100	702708
Micro-vial, polypropylene, transparent, with integrated 0.2 mL glass-insert, conical	0.2 mL	11.6 x 32 mm	100	702134*
Micro-vial, polypropylene, amber, with integrated 0.2 mL glass-insert, conical	0.2 mL	11.6 x 32 mm	100	702334*
Micro-vial, polypropylene, transparent, with inner cone	0.3 mL	11.6 x 32 mm	100	702809
Micro-vial, polypropylene, amber, with inner cone	0.3 mL	11.6 x 32 mm	100	702173
Micro-vial, polypropylene, transparent, with round bottom insert	0.7 mL	11.6 x 32 mm	100	702174

* upon request also available with an integrated silanized glass insert

Pre-assembled vial-insert combinations with snap ring N 11

Vial description	Insert description	Pack of	REF
Vial 702714: 1.5 mL, clear, flat bottom	with pre-assembled micro-insert 702813: 0.2 mL, conical, 15 mm tip	100	702170
Vial 702713: 1.5 mL, clear, flat bottom, label and scale	with pre-assembled micro-insert 702813: 0.2 mL, conical, 15 mm tip	100	702176

Further pre-assembled vial-insert combinations on request.



MACHEREY-NAGEL

CHROMAFIL Finder · easy switching to first-class filters

It is that simple

1. Choose previously used manufacturer
2. Choose previously used part number
3. Start searching
4. Suitable CHROMAFIL® syringe filter will be suggested

Use our CHROMAFIL Finder online at
www.mn-net.com/chromafilfinder



Snap ring vials and caps N 11



Ready assembled snap ring closures N 11 (hard cap)



Cap description	Septa description	Thickness	Pack of	REF
N 11 PE snap ring cap, hard, transparent, center hole	Red Rubber / FEP colorless	1.0 mm	100	702731
N 11 PE snap ring cap, hard, blue, center hole	Red Rubber / FEP colorless	1.0 mm	100	702063
N 11 PE snap ring cap, hard, red, center hole	Red Rubber / FEP colorless	1.0 mm	100	702295



Cap description	Septa description	Thickness	Pack of	REF
N 11 PE snap ring cap, hard, transparent, center hole	Silicone white / PTFE red	1.0 mm	100	702710
N 11 PE snap ring cap, hard, blue, center hole	Silicone white / PTFE red	1.0 mm	100	702710.1
N 11 PE snap ring cap, hard, red, center hole	Silicone white / PTFE red	1.0 mm	100	702095
N 11 PE snap ring cap, hard, green, center hole	Silicone white / PTFE red	1.0 mm	100	702142
N 11 PE snap ring cap, hard, yellow, center hole	Silicone white / PTFE red	1.0 mm	100	702108



Cap description	Septa description	Thickness	Pack of	REF
N 11 PE snap ring cap, hard, transparent, center hole	Silicone white / PTFE blue, cross-slit	1.0 mm	100	702064
N 11 PE snap ring cap, hard, blue, center hole	Silicone white / PTFE blue, cross-slit	1.0 mm	100	702717.2
N 11 PE snap ring cap, hard, red, center hole	Silicone white / PTFE blue, cross-slit	1.0 mm	100	702143
N 11 PE snap ring cap, hard, green, center hole	Silicone white / PTFE blue, cross-slit	1.0 mm	100	702150
N 11 PE snap ring cap, hard, yellow, center hole	Silicone white / PTFE blue, cross-slit	1.0 mm	100	702151



Cap description	Septa description	Thickness	Pack of	REF
N 11 PE snap ring cap, hard, transparent, center hole	PTFE red / Silicone white / PTFE red	1.0 mm	100	702718
N 11 PE snap ring cap, hard, blue, center hole	PTFE red / Silicone white / PTFE red	1.0 mm	100	702718.1



Cap description	Septa description	Thickness	Pack of	REF
N 11 PE cap, transparent, closed top, thin piercing area	-	-	100	702401

Ready assembled snap ring closures N 11 (soft cap)

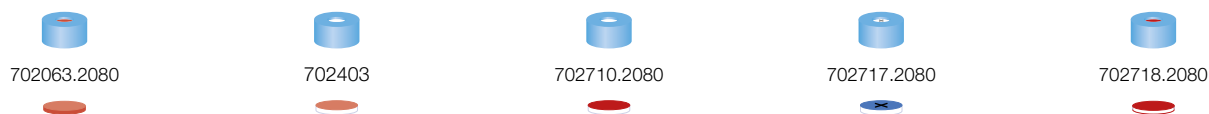

Cap description	Septa description	Thickness	Pack of	REF
N 11 PE snap ring cap, soft, light blue, center hole	Red Rubber / FEP colorless	1.0 mm	100	702063.2080
N 11 PE snap ring cap, soft, light blue, center hole	Silicone white / Polyimide orange (fluorine-free)	1.0 mm	100	702403
N 11 PE snap ring cap, soft, light blue, center hole	Silicone white / PTFE red	1.0 mm	100	702710.2080
N 11 PE snap ring cap, soft, light blue, center hole	Silicone white / PTFE blue, cross-slit	1.0 mm	100	702717.2080
N 11 PE snap ring cap, soft, light blue, center hole	PTFE red / Silicone white / PTFE red	1.0 mm	100	702718.2080



Snap ring vials and caps N 11

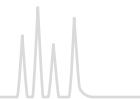

Vial rack for screw neck vials N 8, N 9, N 10 and crimp neck as well as snap ring vials N 11

Description	Pack of	REF
50 position polypropylene vial rack blue, for all vials 11.6 × 32 mm with flat bottom Dimensions: 190 × 100 × 22 mm, stackable	1	702502



Container for screw neck vials N 8, N 9, N 10 and crimp neck as well as snap ring vials N 11

Description	Pack of	REF
81 position container blue, with firmly integrated divider for vials 11.6 × 32 mm, 130 × 130 × 45 mm, coded, with transparent lid (suitable for freezers)	1	702514



Storage of samples in the fridge or in the freezer

Useful tips for sample handling

Generally sample vials should be stored in a vial container when being placed in the fridge or in the freezer, in order to avoid any condensations on the cap/septa surface that may go along with contaminations in the penetration area of the septa in the center hole. When filling the vial you have to consider the expansion rate of your sample to prevent breakage of the vial. Furthermore it is important to defreeze the sample at a later point in time very slowly (no sudden defreezing with hot water for example). With screw closures you may have to check, if restoring forces have been activated during the defreezing process and if you may have to tighten the screw closure. The choice of the correct closure (septum) depends on the storage temperature.





Crimp neck vials and caps N 13



★ Key features

- Usage of these vials and closures is more in the packaging area
- Height adjustable crimpers for aluminum crimp caps as well as for Flip Top / Flip Off crimp caps
- Butyl / PTFE septa with only central PTFE lamination, typically called Pharma-Fix septa, stand out due to their excellent sealing on the glass rims.

Crimp neck vials N 13

Illustrations scale 1:2

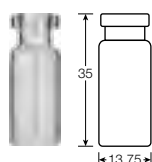

70203

Type of vial	Usable volume	OD × height	Pack of	REF
Clear, flat bottom	2 mL	13.75 × 35 mm	100	70203

Ready assembled crimp closures N 13 and plain crimp caps N 13



70257

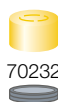

70232



702802

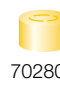

702803

Cap description	Septa description	Thickness	Pack of	REF
N 13 aluminum crimp cap, silver, center hole	Butyl dark gray / PTFE gray*	2 mm	100	70257
N 13 aluminum center tear off cap, gold	Butyl dark gray / PTFE gray*	2 mm	100	70232
N 13 aluminum crimp cap, silver, center hole	no liner	–	100	702802
N 13 aluminum center tear off cap, gold	no liner	–	100	702803

* only centrally laminated with PTFE, typically called Pharma-Fix

Crimping tools N 13

Description	Pack of	REF
Manual crimper (standard), height adjustable, for 13 mm aluminum crimp caps	1 / box	735113
Manual crimper (standard), height adjustable, for 13 mm Flip Top / Flip Off caps	1 / box	735133
Manual decapper (standard) for 13 mm aluminum crimp caps	1 / box	735913
Electronic crimper for 13 mm aluminum crimp caps (battery-powered)	1 / box	735513
Electronic crimper for 13 mm Flip Top / Flip Off caps (battery-powered)	1 / box	735533
Electronic decapper for 13 mm aluminum crimp caps (battery-powered)	1 / box	735613
Electronic high power crimping tool with power supply	1 / box	735700
Crimping head for 13 mm crimp caps	1 / box	735713
Crimping head for 13 mm Flip Top / Flip Off caps	1 / box	735733
Decapping head for 13 mm crimp caps	1 / box	735813

Container for crimp and screw neck vials N 13

Description	Pack of	REF
49 position container blue, with firmly integrated divider, for crimp and screw neck vials N 13, 130 × 130 × 50 mm, with transparent lid (suitable for freezers)	1	702515

Vial rack for crimp and screw neck vials N 13

Description	Pack of	REF
50 position polypropylene vial rack blue, for all vials with a diameter of 15 mm max. and flat bottom Dimensions: 240 × 120 × 28 mm, stackable	1	702504



Screw neck vials and caps N 13

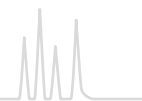

Screw neck vials and caps N 13



★ Key features

- Generally used for large sample volumes in HPLC
- In combination with closed top screw closures suitable for sample storage (see pages 126)
- Compatible insert requires metal spring for central alignment
- Range of ready assembled closures and plain caps with center hole or with closed top as well as separate septa (PTFE virginal, Red Rubber / FEP and Silicone / PTFE) are available.

Screw neck vials N 13 (13-425 thread) and compatible insert

Illustrations scale 1:2

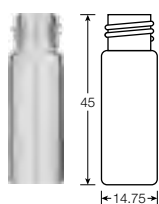

702962

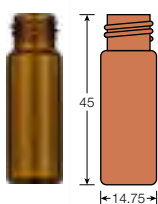

702973

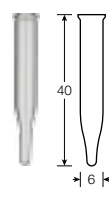

702972



702974

Type of vial	Usable volume	OD × height	Pack of	REF
Clear, flat bottom	4 mL	14.75 × 45 mm	100	702962
Amber, flat bottom	4 mL	14.75 × 45 mm	100	702973
Insert, clear, conical, metal spring required	0.3 mL	6 × 40 mm	100	702972
Metal spring for 702972	–	–	100	702974

Ready assembled screw closures and plain screw caps N 13



702113



702050



702051



702926



702052



702925



702963



702966

Cap description	Septa description	Thickness	Pack of	REF
N 13 PP bonded screw cap, white, closed top	Silicone white/PTFE blue	1.3 mm	100	702113
N 13 PP screw cap, black, center hole	Red Rubber / FEP colorless	1.5 mm	100	702050
as above, but with closed top	Red Rubber / FEP colorless	1.5 mm	100	702051
N 13 PP screw cap, black, center hole	Silicone white / PTFE red	1.3 mm	100	702926
as above, but with closed top	Silicone white / PTFE red	1.3 mm	100	702052
N 13 PP screw cap, black, center hole	Silicone white/PTFE blue, cross-slit	1.5 mm	100	702925
N 13 PP screw cap, black, center hole	no liner	–	100	702963
as above, but with closed top	no liner	–	100	702966

N 12 septa for screw caps N 13

Material	Illustration	Thickness	Pack of	REF
PTFE virginal, white		0.25 mm	100	70260
Red Rubber / FEP colorless		1.5 mm	100	702053
Silicone white / PTFE red		1.3 mm	100	702292



Container for crimp and screw neck vials N 13



Vial rack for crimp and screw neck vials N 13



Screw neck vials for storage of liquid samples



★ Key features

- Usable volumes of 1.5 up to 24 mL
- Available neck sizes N 8, N 9, N 13, N 15, N 18 and N 20
- Corresponding closed top screw closures with different septa materials

Screw neck vials N 8, small opening (8-425 thread)

Illustrations scale 1:2

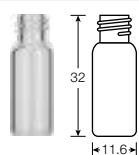

70213



70213.2

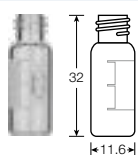

702004



702893



702068



702066

Type of vial	Usable volume	OD × height	Pack of	REF
Clear, flat bottom	1.5 mL	11.6 × 32 mm	100	70213
Amber, flat bottom	1.5 mL	11.6 × 32 mm	100	70213.2
Clear, flat bottom, label and scale	1.5 mL	11.6 × 32 mm	100	702004
Amber, flat bottom, label and scale	1.5 mL	11.6 × 32 mm	100	702893

Closed top screw closures N 8

Cap description	Septa description	Thickness	Pack of	REF
N 8 PP screw cap, black, closed top	Red Rubber / FEP colorless	1.3 mm	100	702068
N 8 PP screw cap, black, closed top	Silicone white / PTFE red	1.3 mm	100	702066

Screw neck vials N 9, wide opening (short thread)

Illustrations scale 1:2

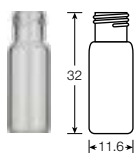

702282



702293

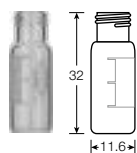

702283



702284



702032



702033



702034

Type of vial	Usable volume	OD × height	Pack of	REF
Clear, flat bottom	1.5 mL	11.6 × 32 mm	100	702282
Amber, flat bottom	1.5 mL	11.6 × 32 mm	100	702293
Clear, flat bottom, label and scale	1.5 mL	11.6 × 32 mm	100	702283
as above, silanized	1.5 mL	11.6 × 32 mm	100	702078
Amber, flat bottom, label and scale	1.5 mL	11.6 × 32 mm	100	702284
as above, silanized	1.5 mL	11.6 × 32 mm	100	702079

Closed top screw closures N 9

Cap description	Septa description	Thickness	Pack of	REF
N 9 PP screw cap blue, closed top	PTFE virginal, white	0.25 mm	100	702032
N 9 PP screw cap blue, closed top	Red Rubber / FEP colorless	1.0 mm	100	702033
N 9 PP screw cap blue, closed top	Silicone white / PTFE red	1.0 mm	100	702034



Special vials and caps

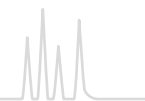

Screw neck vials N 13 (13-425 thread)

Illustrations scale 1:2

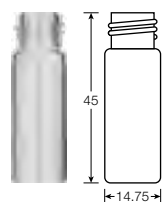

702962

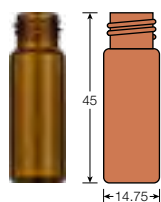

702973



702113



702051



702052

Type of vial	Usable volume	OD × height	Pack of	REF
Clear, flat bottom	4 mL	14.75 × 45 mm	100	702962
Amber, flat bottom	4 mL	14.75 × 45 mm	100	702973

Closed top screw closures N 13

Cap description	Septa description	Thickness	Pack of	REF
N 13 PP bonded screw cap, white, closed top	Silicone white/PTFE blue	1.3 mm	100	702113
N 13 PP screw cap, black, closed top	Red Rubber / FEP colorless	1.5 mm	100	702051
N 13 PP screw cap, black, closed top	Silicone white / PTFE red	1.3 mm	100	702052

Screw neck vials N 15 (15-425 thread)

Illustrations scale 1:2

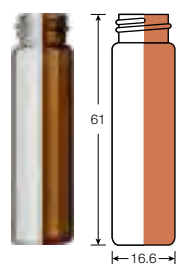

702096 / 702311

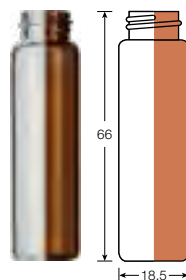

70285 / 702097



702114



702180

Type of vial	Usable volume	OD × height	Pack of	REF
Screw neck vial N 15, clear, flat bottom	8 mL	16.6 × 61 mm	100	702096
Screw neck vial N 15, amber, flat bottom	8 mL	16.6 × 61 mm	100	702311
Screw neck vial N 15, clear, flat bottom	12 mL	18.5 × 66 mm	100	70285
Screw neck vial N 15, amber, flat bottom	12 mL	18.5 × 66 mm	100	702097

Screw closures N 15

Cap description	Septa description	Thickness	Pack of	REF
N 15 PP bonded screw cap, white, closed top	Silicone white/PTFE blue	1.3 mm	100	702114
N 15 PP bonded screw cap, black, center hole	Silicone white / PTFE beige	1.5 mm	100	702180

Container for screw neck vials N 15

Description	Pack of	REF
36 position container blue, with removable divider, for screw neck vials N 15 (sample storage: 702096, 702311, 70285, 702097) 130 × 130 × 80 mm, with transparent lid (suitable for freezers)	1	702518





Screw neck vial N 18 (18-400 thread)

Illustrations scale 1:2

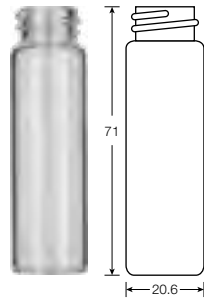

702098



702115

Type of vial	Usable volume	OD × height	Pack of	REF
Screw neck vial N 18, clear, flat bottom	16 mL	20.6 × 71 mm	100	702098

Screw closures N 18

Cap description	Septa description	Thickness	Pack of	REF
N 18 PP bonded screw cap, white, closed top	Silicone white/PTFE blue	1.3 mm	100	702115

Screw neck vials N 20 (20-400 thread)

Illustrations scale 1:2

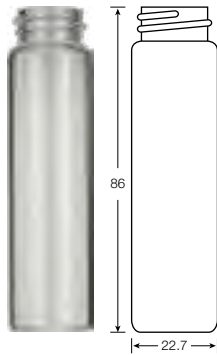

702099



702116



702181

Type of vial	Usable volume	OD × height	Pack of	REF
Screw neck vial N 20, clear, flat bottom	24 mL	22.7 × 86 mm	100	702099

Screw closures N 20

Cap description	Septa description	Thickness	Pack of	REF
N 20 PP bonded screw cap, white, closed top	Silicone white/PTFE blue	1.3 mm	100	702116
N 20 PP bonded screw cap, white, center hole	Silicone white/PTFE beige	1.5 mm	100	702181

For screw neck vials with even larger volumes please see page 137.

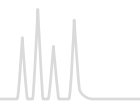

Snap cap vials for storage of powdery samples



★ Key features

- Available sizes N 18 and N 22
- Usable volumes from 5 up to 25 mL
- Glass of 3rd hydrolytic class

Snap cap vials N 18

Illustrations scale 1:2

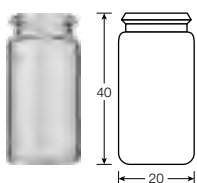

70271

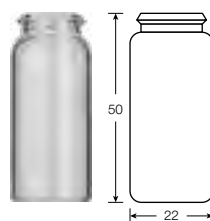

70272



70274

Type of vial	Usable volume	OD × height	Pack of	REF
N 18, clear, flat bottom	5 mL	20 × 40 mm	100	70271
N 18, clear, flat bottom	10 mL	22 × 50 mm	100	70272

PE snap caps N 18

Description	Pack of	REF
N 18 PE snap cap, transparent, for 70271 and 70272	100	70274

Snap cap vials N 22

Illustrations scale 1:2

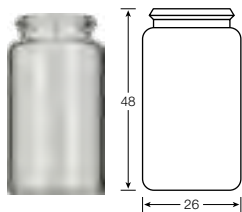

702019

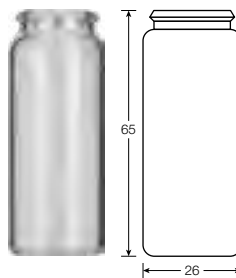

70273



70275

Type of vial	Usable volume	OD × height	Pack of	REF
N 22, clear, flat bottom	15 mL	26 × 48 mm	100	702019
N 22, clear, flat bottom	25 mL	26 × 65 mm	100	70273

PE snap caps N 22

Description	Pack of	REF
N 22 PE snap cap, transparent, for 702019 and 70273	100	70275



Shell vials N 8

★ Key features

- Economic combination of vials and closures for uncritical HPLC application
- Often used on Waters® and Shimadzu® instruments

Shell vials N 8 with PE plug

Illustrations scale 1:2

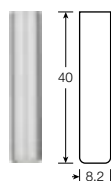

70202.1



702807

Type of vial	Usable volume	OD × height	Pack of	REF
N 8, clear, flat bottom	1 mL	8.2 × 40 mm	100	70202.1

PE plug N 8

Description	Pack of	REF
N 8 PE plug, transparent, for 70202.1	100	702807



Special vials for special applications

Silanized glass vials / Plastic vials / Plastic vials with glass insert

- **Silanized glass vials**
Silanized glass vials have a deactivated inner glass surface, in order to reduce adsorption of polar substances. Therefore they are often used for the analysis of proteins, phenols and amino acids, which would – without any silanization of the glass surface – react with the OH-groups of the glass and thus would stick to the normally polar glass surface. It is also recommendable to use silanized vials respectively inserts for pH-sensitive and aqueous samples.
- **Plastic vials**
For some applications glass vials are not suitable due their composition and their chemical properties. Amongst these are heavy metal analysis, water and protein analysis, atomic absorption, capillary electrophoresis (CE) and ion chromatography (IC). For all these cases high purity polypropylene vials with 0.3 mL, 0.7 mL and 1.5 ml in transparent and amber are available.
- **Plastic vials with glass insert**
In comparison to the glass-in-glass products, glass-in-plastic systems are very robust, as the glass insert is well protected by the polypropylene outer shell. The tip of the micro-insert is centered by 100 per cent in an outlet at the bottom. The insert sits firmly in the protective PP round bottom shell and thus can easily be filled. Another advantage of these systems is their excellent tightness, as the glass insert always constantly exceeds the rim of the plastic outer vial by 0.1 mm granting a firm sealing of the sample in the insert. Upon request also a silanized insert can be integrated into the plastic shell. The high transparent polypropylene enables a good view on the filling level.





Screw neck vials / magnetic screw caps N 18

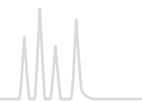

Screw neck vials and magnetic screw caps N 18



★ Key features

- Headspace vials for convenient, safe and consistent handling
- High tightness and better reproducibility of the sealing process (as compared to crimping)
- Thinner septum (1.5 mm instead of 3 mm septum thickness in crimp caps), thus safe penetration of the needle and less fragmentation (especially important for SPME applications)
- Improved run in autosamplers with magnets (CTC Combi PAL and equivalent instruments), since a flat surface for the magnet is ensured, thus avoiding that the filled vial can drop from the magnet

Headspace screw neck vials N 18

Illustrations scale 1:2

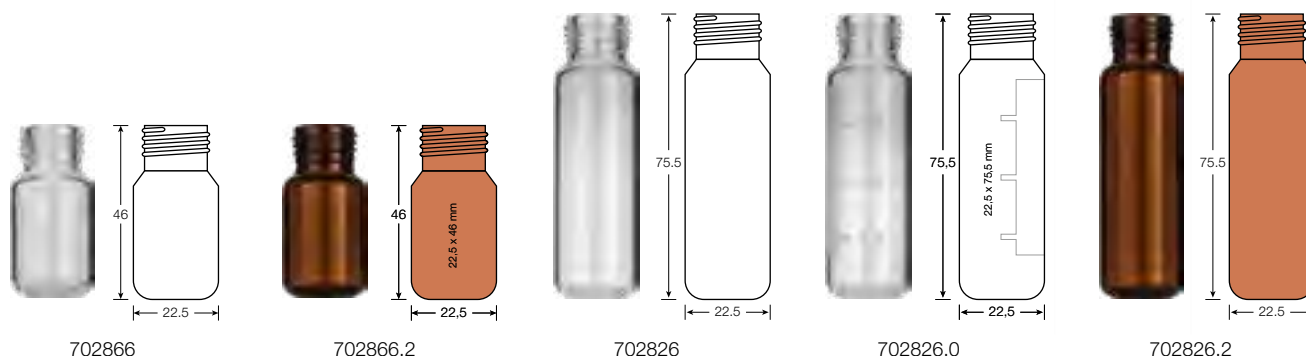

Type of vial	Usable volume	OD × height	Pack of	REF
Clear, rounded bottom	10 mL	22.5 × 46.0 mm	100	702866
Amber, rounded bottom	10 mL	22.5 × 46.0 mm	100	702866.2
Clear, rounded bottom	20 mL	22.5 × 75.5 mm	100	702826
Clear, rounded bottom, label	20 mL	22.5 × 75.5 mm	100	702826.0
Amber, rounded bottom	20 mL	22.5 × 75.5 mm	100	702826.2

Container for screw neck vials N 18 and crimp neck vials N 20

Description	Pack of	REF
25 position container blue, with removable divider, for headspace screw neck vials N 18 and crimp neck vials N 20; 130 × 130 × 80 mm, with transparent lid (suitable for freezers)	1	702516

Vial rack for screw neck vials N 18 and crimp neck vials N 20

Description	Pack of	REF
36 position polypropylene vial rack blue, coded, for vials with a diameter of 23.1 mm max. Dimensions: 323 × 91 × 30 mm, stackable	5	702503



Screw neck vials / magnetic screw caps N 18



Ready assembled, magnetic screw closures N 18

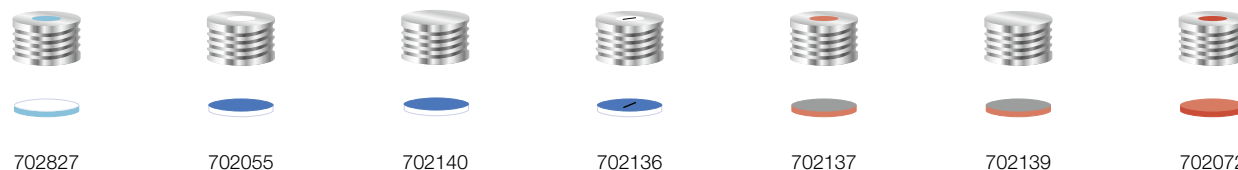

Cap description	Septa description	Thickness	Pack of	REF
N 18 magnetic screw cap, silver, center hole	Silicone blue transparent / PTFE white	1.5 mm	100	702827
N 18 magnetic screw cap, silver, center hole	Silicone white / PTFE blue	1.5 mm	100	702055
N 18 magnetic screw cap, silver, closed top	Silicone white / PTFE blue	1.5 mm	100	702140
N 18 magnetic screw cap, silver, center hole	Silicone white / PTFE blue, slit	1.5 mm	100	702136
N 18 magnetic screw cap, silver, center hole	Butyl red / PTFE gray	1.5 mm	100	702137
N 18 magnetic screw cap, silver, closed top	Butyl red / PTFE gray	1.5 mm	100	702139
N 18 magnetic screw cap, silver, center hole	Red Rubber / TEF colorless	1.5 mm	100	702072

N 17 septa for magnetic screw caps N 18

Material	Illustration	Thickness	Pack of	REF
Silicone blue transparent / PTFE white		1.5 mm	100	702981
Silicone white / PTFE blue		1.5 mm	100	702110
Butyl red / PTFE gray		1.5 mm	100	702138



Safe handling of samples in headspace analysis

10 mL and 20 mL screw neck vials N 18 from MACHEREY-NAGEL with magnetic screw caps are designed for use on headspace autosamplers such as the CTC Combi PAL®.

They offer a more convenient, consistent and secure sealing process than crimping (better reproducibility). Due to the thinner septum (1.5 mm instead of 3 mm), needle penetration is easier and associated with less fragmentation (especially important for SPME applications). The screw caps provide a flat surface for the magnet; thus the filled vial cannot drop down from the magnet, which can be the case with overcrimped vials due to the convexity of the cap going along with it.

The closures are offered with a variety of different septa materials, with silicone/PTFE being recommended for its excellent analytical purity, high temperature resistance and outstanding penetration properties. Closed top closure variants are also available for sample storage / transport.





Crimp neck vials and caps N 20

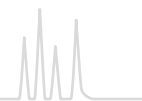

Crimp neck vials and caps N 20

★ Key features

- Large range of Headspace crimp neck vials with different volumes and diameters
- Flat DIN crimp neck with stable bearing surface for the septum (especially suited for high vial pressures) as well as beveled HS crimp neck for instruments of certain manufacturers (PerkinElmer®).
- Assignment to respective instrument manufacturers in parentheses
- Different types of crimp closures depending on instrument and application
- Please consider our various crimping tools on pages 140 – 141.



Crimp neck vials N 20 (volume 5 – 10 mL)

Illustrations scale 1:2



70204.36



70215.36



702917



702020



70205.36



70216.36



702918



702924

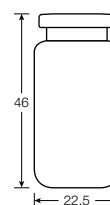
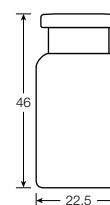
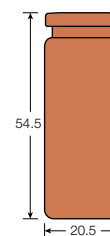
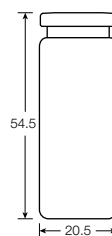
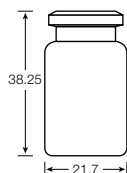
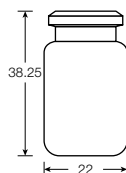
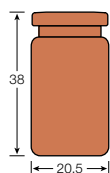
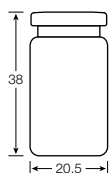

Type of vial	Usable volume	OD x height	Pack of	REF
Clear, flat bottom, flat DIN crimp neck (Varian®)	5 mL	20.5 x 38.0 mm	100	70204.36
Amber, flat bottom, flat DIN crimp neck (Varian®)	5 mL	20.5 x 38.0 mm	100	70215.36
Clear, rounded bottom, beveled HS crimp neck (PerkinElmer®)	6 mL	22.0 x 38.25 mm	100	702917
Clear, flat bottom, beveled HS crimp neck (Metrohm®, Karl-Fischer titration)	5 mL	21.7 x 38.25 mm	100	702020
Clear, flat bottom, flat DIN crimp neck (Varian®)	10 mL	20.5 x 54.5 mm	100	70205.36
Amber, flat bottom, flat DIN crimp neck (Varian®)	10 mL	20.5 x 54.5 mm	100	70216.36
Clear, flat bottom, flat DIN crimp neck (Dani, Agilent®)	10 mL	22.5 x 46.0 mm	100	702918
Clear, rounded bottom, flat DIN crimp neck (CTC)	10 mL	22.5 x 46.0 mm	100	702924



Optimal closure for Headspace analysis:

Silicone/PTFE Pharma-Fix crimp closures 702340 and 702341

- Outstanding sealing properties due to only centrally applied PTFE (Pharma-Fix)
- High analytical purity and high temperature resistance (-60 °C up to 200 °C)
- Safe piercing for the needle due to the softness of Silicone/PTFE
- Lamellar designed side edges for good compressing during crimping
- Additions to our Butyl/PTFE Pharma-Fix closures 70234 / 70234.10





Crimp neck vials N 20 (volume 20 mL)

Illustrations scale 1:2

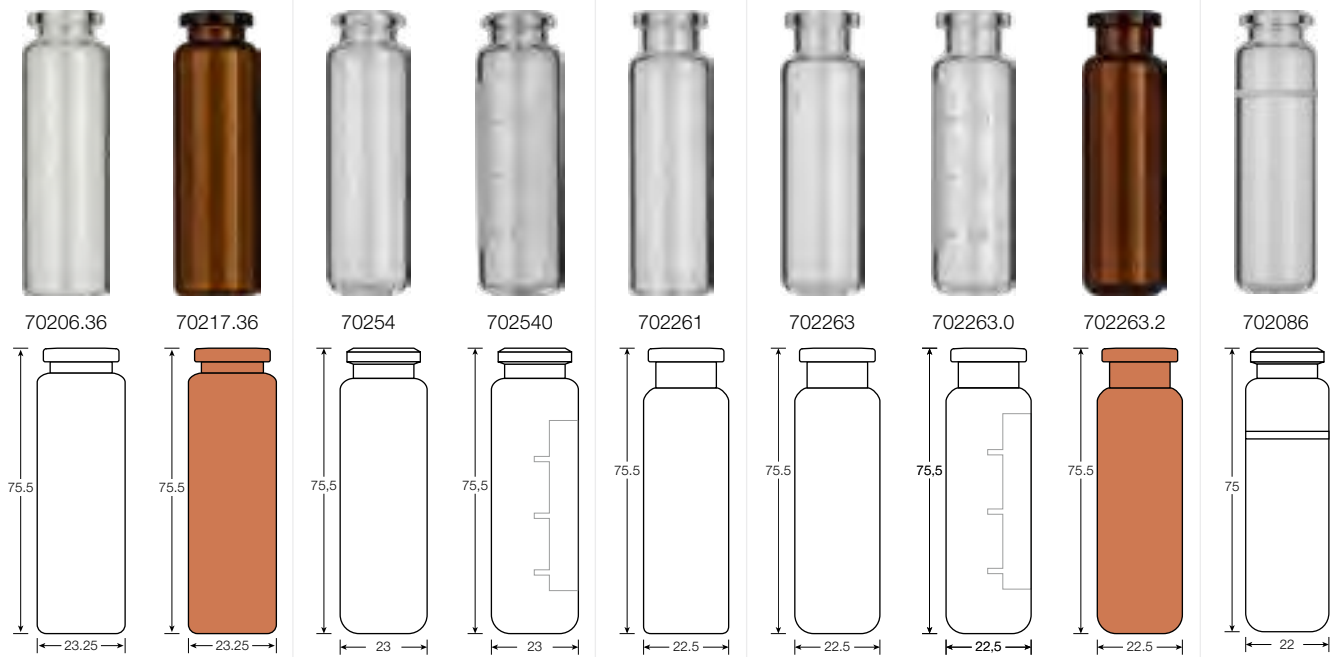

Type of vial	Usable volume	OD x height	Pack of	REF
Clear, flat bottom, flat DIN crimp neck	20 mL	23.25 x 75.5 mm	100	70206.36
Amber, flat bottom, flat DIN crimp neck	20 mL	23.25 x 75.5 mm	100	70217.36
Clear, rounded bottom, beveled HS crimp neck (PerkinElmer®)	20 mL	23.0 x 75.5 mm	100	70254
Clear, rounded bottom, beveled HS crimp neck, label (PerkinElmer®)	20 mL	23.0 x 75.5 mm	100	702540
Clear, flat bottom, flat DIN crimp neck (Dani, Agilent®)	20 mL	22.5 x 75.5 mm	100	702261
Clear, rounded bottom, flat DIN crimp neck (CTC)	20 mL	22.5 x 75.5 mm	100	702263
Clear, rounded bottom, flat DIN crimp neck, label (CTC)	20 mL	22.5 x 75.5 mm	100	702263.0
Amber, rounded bottom, flat DIN crimp neck (CTC)	20 mL	22.5 x 75.5 mm	100	702263.2
Clear, rounded bottom, beveled HS crimp neck, graduation at 15 mL	20 mL	22.0 x 75.0 mm	100	702086

Container for screw neck vials N 18 and crimp neck vials N 20

Description	Pack of	REF
25 position container blue, with removable divider, for headspace screw neck vials N 18 and crimp neck vials N 20; 130 x 130 x 80 mm, with transparent lid (suitable for freezers)	1	702516

Vial rack for screw neck vials N 18 and crimp neck vials N 20

Description	Pack of	REF
36 position polypropylene vial rack blue, coded, for vials with a diameter of 23.1 mm max. Dimensions: 323 x 91 x 30 mm, stackable	5	702503





Crimp neck vials and caps N 20

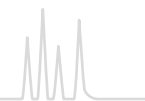

Crimp neck vials N 20 (volume > 20 mL)

Illustrations scale 1:2



Type of vial	Usable volume	OD x height	Pack of	REF
Clear, flat bottom, flat DIN crimp neck	25 mL	30 x 65 mm	100	70210.36
Clear, flat bottom, flat DIN crimp neck	50 mL	31 x 101 mm	100	70208.36
Clear, flat bottom, flat DIN crimp neck (3 rd hydrolytic class)	100 mL	51.6 x 94.5 mm	88	70209.1

Crimping tools N 20

Description		Pack of	REF
Manual crimper (standard), height adjustable, for 20 mm aluminum crimp caps		1	735120
Manual crimper (standard), height adjustable, for 20 mm Flip Top / Flip Off caps		1	735132
Manual decapper (standard) for 20 mm aluminum crimp caps		1	735920
Manual ergonomic crimper for 20 mm aluminum crimp caps		1	735220
Manual ergonomic decapper for 20 mm aluminum crimp caps		1	735320
Electronic crimper for 20 mm aluminum crimp caps (battery-powered)		1	735520
Electronic crimper for 20 mm Flip Top / Flip Off caps (battery-powered)		1	735532
Electronic decapper for 20 mm aluminum crimp caps (battery-powered)		1	735620
Electronic high power crimping tool with power supply		1	735700
Crimping head for 20 mm crimp caps (aluminum, magnetic, bi-metal)		1	735720
Crimping head for 20 mm Flip Top / Flip Off caps		1	735732
Decapping head for 20 mm crimp caps (aluminum, magnetic, bi-metal)		1	735820
Stand for electronic crimping tools		1	735501
Replacement battery 6.6 V, 8.6 Wh for 735520, 735532, 735620		1	735500
Rack for two crimping tools either type ergonomic (manual) or electronic, blue, 240 x 95 x 65 mm		1	735509



Crimp neck vials and caps N 20



Ready assembled crimp closures N 20

Center hole caps

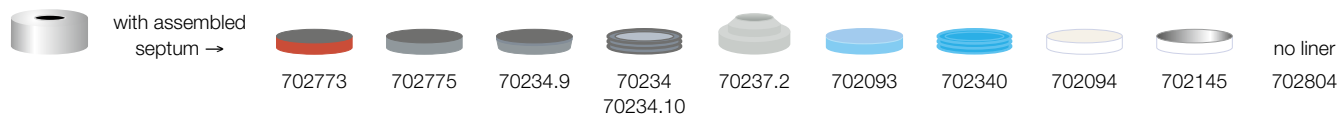

Cap description	Septa description	Thickness	Pack of	REF
N 20 aluminum crimp cap, silver, center hole	Butyl red / PTFE gray	3 mm	100	702773
N 20 aluminum crimp cap, silver, center hole	Butyl light gray / PTFE dark gray	3 mm	100	702775
N 20 aluminum crimp cap, silver, center hole	Molded septum Butyl / PTFE gray	3 mm	100	70234.9
N 20 aluminum crimp cap, silver, center hole	Butyl dark gray / PTFE gray*	3 mm	100	70234
N 20 aluminum crimp cap, silver, center hole	Butyl dark gray / PTFE gray*, high purity	3 mm	100	70234.10
N 20 aluminum crimp cap, silver, center hole	Bromobutyl stopper gray, unassembled (separate parts)	-	100 each	70237.2
N 20 aluminum crimp cap, silver, center hole	Silicone blue transp. / PTFE colorless	3 mm	100	702093
N 20 aluminum crimp cap, silver, center hole	Silicone blue transparent / central PTFE lamination colorless*	3 mm	100	702340
N 20 aluminum crimp cap, silver, center hole	Silicone white / PTFE beige	3 mm	100	702094
N 20 aluminum crimp cap, silver, center hole	Silicone white / FEP- / aluminum foil silver	3.2 mm	100	702145
N 20 aluminum crimp cap, silver, center hole	no liner	-	100	702804
N 20 aluminum crimp cap, gold, center hole	no liner	-	100	702112

Pressure release caps

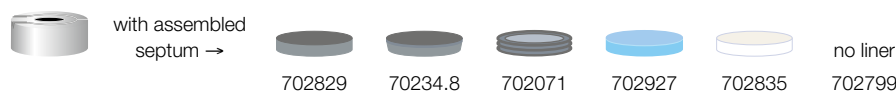

Cap description	Septa description	Thickness	Pack of	REF
N 20 aluminum pressure release cap, silver, center hole	Butyl light gray / PTFE dark gray	3 mm	100	702829
N 20 aluminum pressure release cap, silver, center hole	Molded septum Butyl / PTFE gray	3 mm	100	70234.8
N 20 aluminum pressure release cap, silver, center hole	Butyl dark gray / PTFE gray*	3 mm	100	702071
N 20 aluminum pressure release cap, silver, center hole	Silicone blue transp. / PTFE colorless	3 mm	100	702927
N 20 aluminum pressure release cap, silver, center hole	Silicone white / PTFE beige	3 mm	100	702835
N 20 aluminum pressure release cap, silver, center hole	no liner	-	100	702799

Bi-metal crimp caps

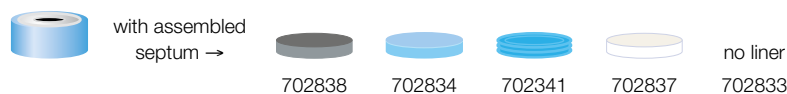

Cap description	Septa description	Thickness	Pack of	REF
N 20 Bi-metal crimp cap, blue / silver, center hole	Butyl light gray / PTFE dark gray	3 mm	100	702838
N 20 Bi-metal crimp cap, blue / silver, center hole	Silicone blue transp. / PTFE colorless	3 mm	100	702834
N 20 Bi-metal crimp cap, blue/silver, center hole	Silicone blue transparent / central PTFE lamination colorless*	3 mm	100	702341
N 20 Bi-metal crimp cap, blue / silver, center hole	Silicone white / PTFE beige	3 mm	100	702837
N 20 Bi-metal crimp cap, blue / silver, center hole	no liner	-	100	702833

Magnetic crimp caps

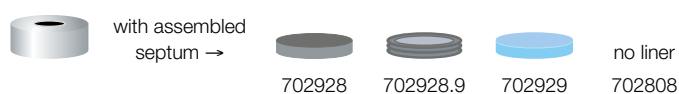

Cap description	Septa description	Thickness	Pack of	REF
N 20 magnetic crimp cap, silver, 8 mm center hole	Butyl light gray / PTFE dark gray	3 mm	100	702928
N 20 magnetic crimp cap, silver, 8 mm center hole	Butyl dark gray / PTFE gray*	3 mm	100	702928.9
N 20 magnetic crimp cap, silver, 8 mm center hole	Silicone blue transp. / PTFE colorless	3 mm	100	702929
N 20 magnetic crimp cap, silver, 8 mm center hole	no liner	-	100	702808

* only centrally laminated with PTFE, typically called Pharma-Fix



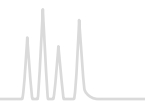

Crimp neck vials and caps N 20







Ready assembled crimp closures N 20







Center tear off caps

		70233		no liner	70236.1
Cap description	Septa description	Thickness	Pack of	REF	
N 20 aluminum center tear off cap, gold	Butyl dark gray / PTFE gray*	3 mm	100	70233	
N 20 aluminum center tear off cap, silver	no liner	–	100	70236.1	

Complete tear off caps



		70235			702839		no liner	702805
Cap description	Septa description	Thickness	Pack of	REF				
N 20 aluminum complete tear off cap, silver	Butyl dark gray / PTFE gray*	3 mm	100	70235				
N 20 aluminum complete tear off cap, silver	Silicone white/PTFE beige	3 mm	100	702839				
N 20 aluminum complete tear off cap, silver	no liner	–	100	702805				

N 20 septa for crimp caps N 20





Material	Illustration	Thickness	Pack of	REF
Butyl red / PTFE gray		3 mm	100	70277
Butyl light gray / PTFE dark gray		3 mm	100	702057
Molded septum Butyl / PTFE gray		3 mm	100	702101
Butyl dark gray / PTFE gray*		3 mm	100	702D20TB
Silicone blue transparent / PTFE colorless		3 mm	100	702780
Silicone white / PTFE beige		3 mm	100	70278

* only centrally laminated with PTFE, typically called Pharma-Fix



Stoppers N 20

Material	Illustration	Pack of	REF
Bromobutyl gray		100	702931.3
Bromobutyl red		100	702931.1

PE caps N 20

height 8.4 mm		70266		702128	height 9.1 mm		70267		702129
Description	Pack of	REF							
N 20 PE cap, transparent, for beveled HS crimp neck N 20, 4.3 mm center hole (no liner)	100	70266							
as above, but with septum Butyl beige / PTFE gray, unassembled, 1.3 mm	100	70242							
as above, but with assembled septum Natural rubber red-orange / TEF colorless, 1.3 mm	100	702128							
N 20 PE cap, transparent, for flat DIN crimp neck N 20, 4.3 mm center hole (no liner)	100	70267							
as above, but with septum Butyl beige / PTFE gray, unassembled, 1.3 mm	100	70240							
as above, but with assembled septum Natural rubber red-orange / TEF colorless, 1.3 mm	100	702129							

N 19 septa for PE caps N 20

Description	Illustration	Thickness	Pack of	REF
Butyl beige / PTFE gray		1.3 mm	100	70269
Natural rubber red-orange / TEF colorless		1.3 mm	100	702904
Silicone blue transparent / PTFE white		1.3 mm	100	702144

Screw neck vials and caps N 24



Screw neck vials and caps N 24 (EPA)



★ Key features

- Recommended for VOC and TOC analyses
- Closed top screw closures for sample storage
- Most frequently used: 40 mL clear glass
- Often called EPA vials, since they are defined in the regulations of the US Environmental Protection Agency
- Due to their size mainly used as bonded closure for a firm fit of the septum
- Recommended for environmental analysis: screw closure with center hole and Silicone / PTFE septum
- Universal screw closure 702168 with removable protection lid for sample storage and analysis

Screw neck vials N 24 (EPA)

Illustrations scale 1:2

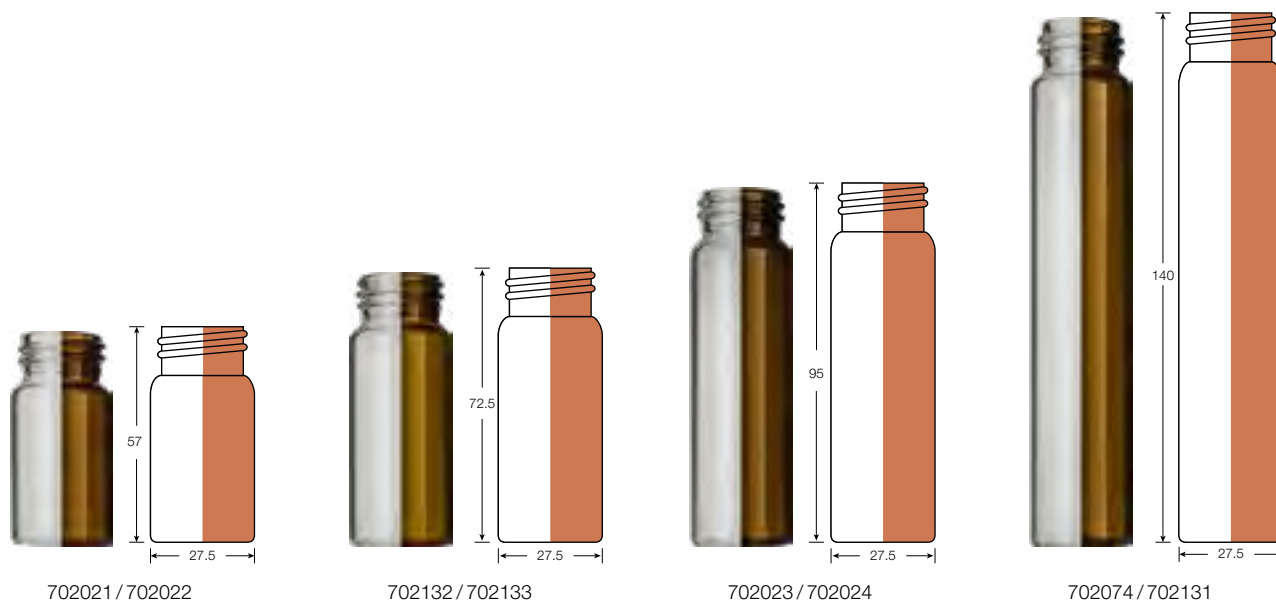

Type of vial	Usable volume	OD x height	Pack of	REF
Clear, flat bottom	20 mL	27.5 x 57.0 mm	100	702021
Amber, flat bottom	20 mL	27.5 x 57.0 mm	100	702022
Clear, flat bottom	30 mL	27.5 x 72.5 mm	100	702132
Amber, flat bottom	30 mL	27.5 x 72.5 mm	100	702133
Clear, flat bottom	40 mL	27.5 x 95.0 mm	100	702023
Amber, flat bottom	40 mL	27.5 x 95.0 mm	100	702024
Clear, flat bottom	60 mL	27.5 x 140 mm	100	702074
Amber, flat bottom	60 mL	27.5 x 140 mm	100	702131

Container for screw neck vials N 24

Description	Pack of	REF
16 position container blue, with removable divider, for screw neck vials N 24 (20 mL, 30 mL, 40 mL); 130 x 130 x 102 mm, with transparent lid (suitable for freezers)	1	702517



Screw neck vials and caps N 24

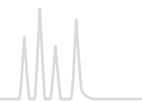

Screw closures N 24 and plain screw caps N 24

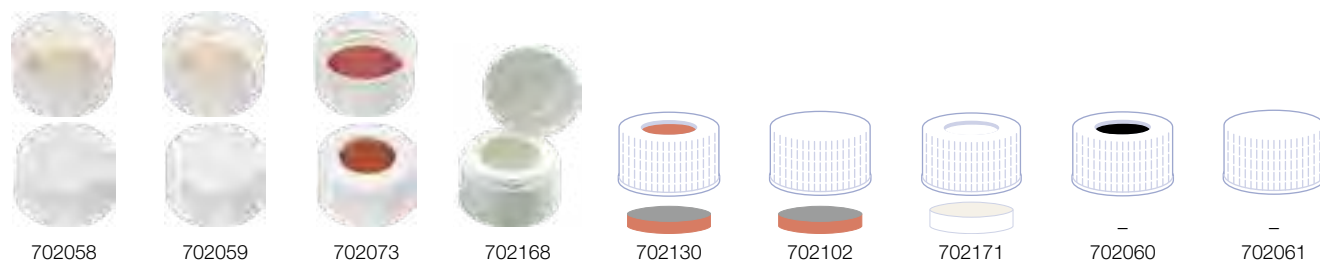

Cap description	Septa description	Thickness	Pack of	REF
N 24 PP bonded* screw cap, white, center hole	Silicone white / PTFE beige	3.2 mm	100	702058
as above, but with closed top	Silicone white / PTFE beige	3.2 mm	100	702059
N 24 PP bonded* screw cap, white, center hole	Red Rubber / TEF colorless	2.5 mm	100	702073
N 24 PP bonded* screw cap, white, center hole, with removable protection lid	Silicone natural / PTFE colorless	3.2 mm	100	702168
N 24 PP screw cap, white, center hole	Butyl red / PTFE gray	2.4 mm	100	702130
as above, but with closed top	Butyl red / PTFE gray	2.4 mm	100	702102
N 24 PP screw cap, white, center hole	Silicone white / PTFE beige	3.2 mm	100	702171
N 24 PP screw cap, white, center hole	no liner		100	702060
as above, but with closed top	no liner		100	702061

* septum firmly connected with the cap, cannot be removed

Septa N 22 for screw caps N 24

Material	Illustration	Thickness	Pack of	REF
Silicone natural / PTFE colorless		3.2 mm	100	702062
Butyl red / PTFE gray		2.4 mm	100	702791

Pre-sealed vial-closure combinations with screw neck N 24

Vial description	Closure description	Pack of	REF
Pre-sealed vials 702021: 20 mL screw neck vial N 24, 27.5 × 57 mm, clear, flat bottom	pre-screwed with 702073: N 24 PP screw cap (bonded), white, center hole, Red Rubber / TEF colorless, 2.5 mm	100	702865
Pre-sealed vials 702021: 20 mL screw neck vial N 24, 27.5 × 57 mm, clear, flat bottom	pre-screwed with 702058: N 24 PP screw cap (bonded), white, center hole, Silicone white / PTFE beige, 3.2 mm	100	702894
Pre-sealed vials 702021: 20 mL screw neck vial N 24, 27.5 × 57 mm, clear, flat bottom	pre-screwed with 702059: N 24 PP screw cap (bonded), white, closed top, Silicone white / PTFE beige, 3.2 mm	100	702884
Pre-sealed vials 702132: 30 mL screw neck vial N 24, 27.5 × 72.5 mm, clear, flat bottom	pre-screwed with 702058: N 24 PP screw cap (bonded), white, center hole, Silicone white / PTFE beige, 3.2 mm	100	702831
Pre-sealed vials 702023: 40 mL screw neck vial N 24, 27.5 × 95 mm, clear, flat bottom	pre-screwed with 702058: N 24 PP screw cap (bonded), white, center hole, Silicone white / PTFE beige, 3.2 mm	100	702877
Pre-sealed vials 702023: 40 mL screw neck vial N 24, 27.5 × 95 mm, clear, flat bottom	pre-screwed with 702168: N 24 PP screw cap (bonded), white, 15 mm center hole, with removable protection lid, Silicone natural / PTFE colorless, 3.2 mm	100	702872
Pre-sealed vials 702131: 60 mL screw neck vial N 24, 27.5 × 140 mm, amber, flat bottom	pre-screwed with 702058: N 24 PP screw cap (bonded), white, center hole, Silicone white / PTFE beige, 3.2 mm	100	702886

Other pre-sealed vial-closure combinations on request



Containers / Vial racks



★ Key features

- Containers allow a secure transportation of sample vials
- Safe standing position in dividers designed for the respective diameter
- Ideal for space-saving storage in fridges, since the transparent lid prevents condensations on the closures and thus avoids a possible contamination in the cooling unit
- Available for all 1.5 mL vials (standard volume), for crimp and screw neck vials N 13, for storage screw neck vials N 15 and for headspace vials with screw neck N 18 or crimp neck N 20, respectively as well as for EPA screw neck vials N 24

Containers

Description	Pack of	REF
81 position container blue, with integrated divider for all vials 11.6 × 32 mm 130 × 130 × 45 mm, coded, with transparent lid (suitable for freezers)	1	702514
49 position container blue, with integrated divider for crimp and screw neck vials N 13; 130 × 130 × 50 mm, with transparent lid (suitable for freezers)	1	702515
25 position container blue, with removable divider for headspace screw neck vials N 18 and crimp neck vials N 20; 130 × 130 × 80 mm, with transparent lid (suitable for freezers)	1	702516
36 position container blue, with removable divider, for screw neck vials N 15 (sample storage: 702096, 702311, 70285, 702097) 130 × 130 × 80 mm, with transparent lid (suitable for freezers)	1	702518
16 position container blue, with removable divider for screw neck vials N 24 (20 mL, 30 mL, 40 mL); 130 × 130 × 102 mm, with transparent lid (suitable for freezers)	1	702517

Vial racks

Description	Pack of	REF
50 position polypropylene vial rack blue, for all vials 11.6 × 32 mm with flat bottom Dimensions: 190 × 100 × 22 mm, stackable	1	702502
50 position polypropylene vial rack blue, for all vials with a diameter of 15 mm max. and flat bottom Dimensions: 240 × 120 × 28 mm, stackable	1	702504
36 position polypropylene vial rack blue, for all vials with a diameter of 23.1 mm max. and flat bottom Dimensions: 323 × 91 × 30 mm, stackable	5	702503





Crimping tools

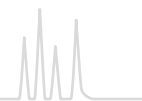

Manual crimping tools

Advanced ergonomic version



Crimper available for 8 mm, 11 mm and 20 mm crimp caps

- More lightweight than complete steel crimpers
- Ergonomically designed handles
- Adjustment by a knob on the crimping head that is easily accessible and visible
- Activated by bottom handle motion only which allows a steadier and safer hold of the tool during crimping
- Due to design and alignment of the crimping head better vertical clearance over the vial

Advanced ergonomic decappers allow safe removal of caps; no adjustment required (for 11 and 20 mm crimp caps available)

Standard version



Crimper available for 8, 11, 13 and 20 mm crimp caps

- Adjustable crimping height via hexagon key, which allows to move the inner part of the crimping head up and down (not possible for manual crimpers N 8)
- Crimping pressure adjustable via screw in the handle
- Manual crimpers for N 13 and N 20 Flip Top / Flip Off caps (pharmaceutical closures) available
- Long life time and convenient handling

Manual decappers (standard version) allow safe removal of caps; no adjustment required

Description	Pack of	REF
Manual crimpers (ergonomic)		
<u>Crimping pressure adjustable by knob on the crimping head</u>		
Manual ergonomic crimper for 8 mm crimp caps	1	735208
Manual ergonomic crimper for 11 mm crimp caps	1	735211
Manual ergonomic crimper for 20 mm crimp caps	1	735220
Manual decappers (ergonomic)		
Manual ergonomic decapper for 11 mm crimp caps	1	735311
Manual ergonomic decapper for 20 mm crimp caps	1	735320
Manual crimpers (standard)		
<u>Crimping height: adjustable by a hexagon key in the crimping head</u>		
<u>Crimping pressure: adjustable by a screw in the handle</u>		
Manual crimper for 8 mm crimp caps	1	735126
Manual crimper, height adjustable, for 11 mm crimp caps	1	735111
Manual crimper, height adjustable, for 13 mm crimp caps	1	735113
Manual crimper, height adjustable, for 13 mm Flip Top / Flip Off crimp caps	1	735133
Manual crimper, height adjustable, for 20 mm crimp caps	1	735120
Manual crimper, height adjustable, for 20 mm Flip Top / Flip Off crimp caps	1	735132
Manual decappers (standard)		
Manual decapper for 8 mm crimp caps	1	735408
Manual decapper for 11 mm crimp caps	1	735911
Manual decapper for 13 mm crimp caps	1	735913
Manual decapper for 20 mm crimp caps	1	735920



Electronic crimping tools

Battery-powered electronic crimping tools



Available for 11 mm and 20 mm aluminum crimp caps (not suitable for magnetic/bi-metal crimp caps). Mobile tools for consistent and reproducible crimping results

- Crimping pressure adjustable by pushing the up and down buttons of the control unit on top of the tool
- Long lasting lithium ion cell batteries (full battery charge for several hundred vials, life time of battery > 1500 charges)
- CE certificate of conformity along with one year warranty
- One tool each necessary for crimping and for decapping
- For more convenient handling a stand is optionally available

Electronic high power crimping tool



Available for 11 mm, 13 mm and 20 mm crimp caps (also suitable for magnetic/bi-metal crimp caps). Due to a more powerful motor also suitable for magnetic and bi-metal crimp caps

- Fixed power supply
- Exchangeable crimping / decapping heads
- Settings mode with language selection, change of jaw set, statistics, log data and different reset options
- CE certificate of conformity along with one year warranty
- For more convenient handling a stand is optionally available

Description	Pack of	REF
Electronic crimpers (battery-powered)		
Electronic crimper for 11 mm aluminum crimp caps (not suitable for magnetic crimp caps)	1	735511
Electronic crimper for 13 mm aluminum crimp caps	1	735513
Electronic crimper for 13 mm Flip Top/Flip Off caps	1	735533
Electronic crimper for 20 mm aluminum crimp caps (not suitable for magnetic /bi-metal crimp caps)	1	735520
Electronic crimper for 20 mm Flip Top/Flip Off caps	1	735532
Electronic decappers (battery-powered)		
Electronic decapper for 11 mm aluminum crimp caps	1	735611
Electronic decapper for 13 mm aluminum crimp caps	1	735613
Electronic decapper for 20 mm aluminum crimp caps (not suitable for magnetic /bi-metal crimp caps)	1	735620
Accessories for battery-powered electronic crimping / decapping tools		
Replacement battery 6.6 Volt, 8.6 Wh	1	735500
Stand for electronic crimping tools	1	735501
Rack for two crimping tools either type ergonomic (manual) or electronic, blue, 240 × 95 × 65 mm	1	735509
Electronic high power crimping tool		
Electronic high power crimping tool with power supply (please order exchangeable crimping / decapping heads separately)	1	735700
Accessories for 735700		
Crimping head for 11 mm crimp caps (for electronic high power crimping tool 735700)	1	735711
Crimping head for 13 mm crimp caps (for electronic high power crimping tool 735700)	1	735713
Crimping head for 13 mm Flip Top/Flip Off caps (for electronic high power crimping tool 735700)	1	735733
Crimping head for 20 mm crimp caps (for electronic high power crimping tool 735700)	1	735720
Crimping head for 20 mm Flip Top/Flip Off caps (for electronic high power crimping tool 735700)	1	735732
Decapping head for 11 mm crimp caps (for electronic high power crimping tool 735700)	1	735811
Decapping head for 13 mm crimp caps (for electronic high power crimping tool 735700)	1	735813
Decapping head for 20 mm crimp caps (for electronic high power crimping tool 735700)	1	735820
Stand for electronic crimping tools	1	735501

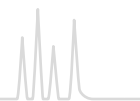

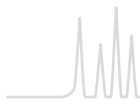

Contents

Basics.....	144
USP listing.....	148
NUCLEODUR® high purity silica for HPLC.....	150
NUCLEODUR® for UHPLC.....	151
NUCLEODUR® phase overview.....	152
NUCLEODUR® columns.....	158
NUCLEOSHELL® core-shell silica for HPLC.....	192
NUCLEOSHELL® phase overview.....	198
NUCLEOSHELL® columns.....	200
NUCLEOSIL® standard silica for HPLC.....	217
NUCLEOSIL® phase overview.....	218
NUCLEOSIL® columns.....	220
Phase overview for special separations.....	231
HPLC columns for environmental analyses.....	232
HPLC columns for enantiomer separations.....	238
HPLC columns for biochemical separations.....	244
HPLC columns for sugar analyses.....	253
Columns for gel permeation chromatography.....	257
MN column systems.....	258
Accessories.....	262
Packings for preparative applications:	
NUCLEODUR® high purity silica for HPLC.....	264
POLYGOSIL® irregular silica for HPLC.....	265
POLYGOPREP irregular silica for HPLC.....	266
Adsorbents for column chromatography.....	268

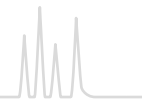

High performance liquid chromatography (HPLC) is part of liquid chromatographic separating processes of substance mixtures and their analysis. At the beginning the technique was also called high pressure liquid chromatography due to the high back pressure of the column. HPLC offers qualitative (identification of substances) and quantitative (concentration determination) analysis by comparison with standard substances. The term HPLC was introduced in the 1970s for the delineation of the high-performance method to the in the 1930s developed column liquid chromatography (column chromatography). At the beginning of the 21st century HPLC was complemented by the even more efficient UHPLC (ultra high performance liquid chromatography). Hereby, even higher pressures (> 400 bar) result in shorter analysis time and enhanced efficiency enabling a higher sample throughput with smaller sample volumes.

Application

HPLC/UHPLC is used additionally to gas chromatography (GC) for separation and determination of complex substance mixtures composed of low-volatile, polar and ionic, high-molecular or thermal instable substances. Therefore, a sufficient solubility of the sample in a solvent or a solvent mixture is required. HPLC/UHPLC is used for purity control of chemicals and industrial products, determination of active agents for drug development, production and testing, environmental analytics, quality and purity control of foods, analysis of ingredients in cosmetics as well as for the isolation of biopolymers.

Basic principle

In liquid column chromatography a mobile phase (eluent) flows through a particle filled tube (stationary phase, separation column). In classic column chromatography this tube is a glass column with an inner diameter of several centimeters and a length up to 450 mm or even bigger. The filling material typically consists of coarse-grained particles like silica gel 60. The eluent is transported through the separation column either by hydrostatic pressure or a low-pressure pump with 1.5–2 bar.

In contrast HPLC columns consist of stainless steel with an inner diameter of 2–4.6 mm and a length of 20–300 mm. The column packing, mostly modified porous silica, has generally a particle size of 3, 5, 7 or 10 μm and a pore size of 50, 100, 120 (for low-molecular analytes) or 300–4000 \AA (for high-molecular analytes). In UHPLC shorter columns in the range of 20–150 mm length with highly efficient particles of 1.8 μm size (sub-2 μm) are utilized. A guard column of a few millimeters length can be utilized and installed with a specific Column Protection System to increase the column lifetime. HPLC/UHPLC uses a high-pressure pump to transport the eluent from a storage vessel into the system with a column back pressure of up to 600/1200 bar.

Instrument

HPLC as well as UHPLC instruments have different building blocks. The storage vessel (eluent reservoir, 1) usually contains a deaerator unit (3) for the solvents. Followed by a gradient valve (4) with mixing chamber (5) in flow direction, which allows the usage of isocratic as well as gradient methods. A high-pressure pump (6) transports the sample into the system. The sample is injected via an injection valve (7). Usually this is operated automatically with a syringe by an autosampler. With the eluent flow the sample is transported to the guard and the separation column (8). For better reproducibility of the separation tempering with a column oven (2) should be performed. The separated substances are determined with a detector (9). In the resulting chromatogram each detector signal of a substance (peak), is related to the retention time of the column. With the data evaluation (10) these peaks can be identified and their concentration can be determined.

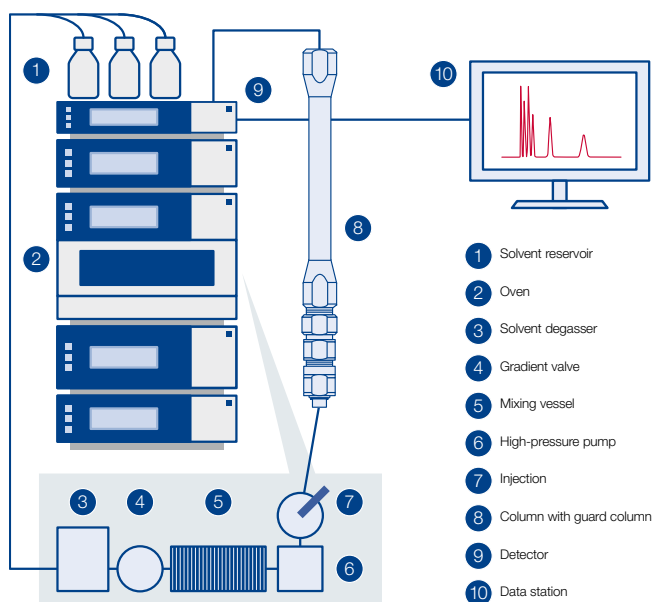



Separation mechanism

While flowing through the column each component of the solved mixture interacts differently with the stationary phase. According to the characteristics of the substance (hydrophobic, polar, ionic, aromatic, sterically hindered etc.) the strength of the interactions vary and thus, the compounds are retained by the stationary phase in different ways. Essentially a distinction is drawn between normal phase (NP), reversed phase (RP) and ion exchange chromatography. Depending on the structure of the stationary phase diverse interactions e. g., van der Waals forces or π - π -stacking can occur and different polar mobile phases are required. For polar stationary normal phases (e. g., SiOH, CN, OH, NH₂) non-polar eluents like *n*-heptane, hexane, dichloromethane or 2-propanol are applicable. While for reversed phases (e. g., C₁₈, C₈, C₄, C₂, C₆H₅) typically polar RP eluents (e. g., acetonitrile or methanol with ultrapure water or buffer) and for ion exchange (e. g., SA, SB) aqueous buffers (e. g., phosphate, acetate, citric buffer) come to use.

Selectivity

The characteristic separation behavior of phases under certain conditions is also called selectivity. This is dependent on different parameters like structure and modifications of the base silica gel, nature of the chemical binding or the type of endcapping. In recent decades several methods have been developed to compare and distinguish the selectivity of various silica gels and their modifications. In this connection defined substances or substance classes are analyzed and the chromatographic parameters are graphically presented. A frequently applied model in specialist literature is e. g., the TANAKA plot, which allows a quick comparison of different HPLC phases. [4]

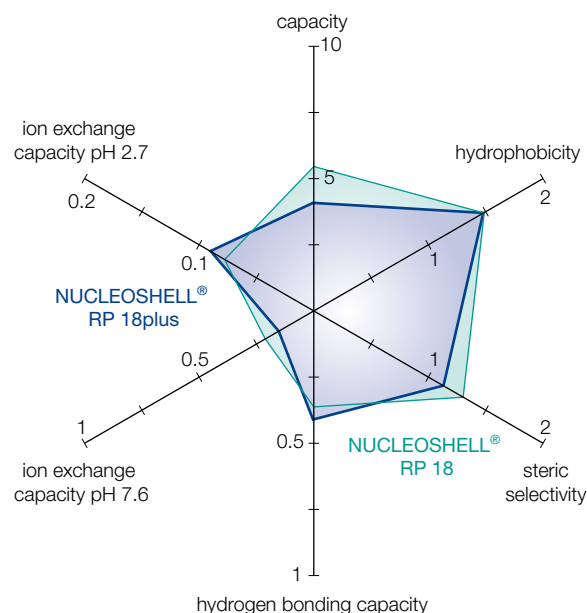

Parameter of the Tanaka diagram:

Capacity = k' (pentylbenzene)

Hydrophobicity = α (pentylbenzene, butylbenzene)

Steric selectivity = α (triphenyl, *o*-terphenyl)

Hydrogen bonding capacity (capacity of silanol) = α (caffeine, phenol)

Ion exchange capacity at pH 2.7 = α (benzylamine, phenol)

Ion exchange capacity at pH 7.6 = α (benzylamine, phenol)

The comparison of NUCLEOSHELL® RP 18 and NUCLEOSHELL® RP 18plus for example shows a lower ion exchange capacity at pH 7.6 for the monomeric NUCLEOSHELL® RP 18plus. The radar chart also reflects a more pronounced steric selectivity of NUCLEOSHELL® RP 18 due to a higher density of modifications with C₁₈ chains.

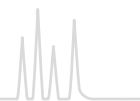

Characteristic parameters

The success of a chromatographic separation depends apart from the stationary and mobile phase also on other characteristics like the quality of the separating column or the linear flow rate. The following schematic chromatogram illustrates the most important parameters which characterize a separation.

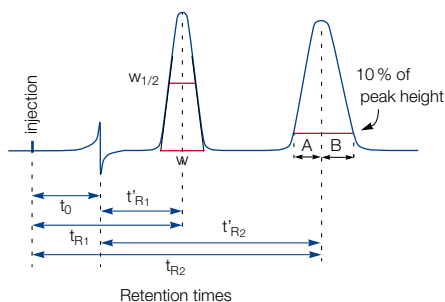

Schematic chromatogram

Peak width:

- $w_{1/2}$ peak width at half height
- w peak width of the peak (intersection point of the inflectional tangents with the zero line)

Peak symmetry:

- A peak front to peak maximum at 10 % of peak height
- B peak maximum to peak end at 10 % of peak height

Retention time:

- t_0 dead time of a column = retention time of a non-retarded substance
- t_{R1}, t_{R2} retention times of components 1 and 2
- t'_{R1}, t'_{R2} net retention times of components 1 and 2

In a chromatographic system the substances differ from each other in their retention time in or on the stationary phase. The time, which is needed by a sample component to migrate from column inlet (sample injection) to the column end (detector) is the retention time t_{R1} or t_{R2} . The dead time t_0 is the time required by an inert compound to migrate from column inlet to column end without any retardation by the stationary phase. Consequently, the dead time is identical with the retention time of the sample component remaining in the stationary phase. The difference of total retention time and dead time yields the net retention time t'_{R1} or t'_{R2} , which is the time a sample component remains in the stationary phase.

$$t'_{R1} = t_{R1} - t_0 \text{ bzw. } t'_{R2} = t_{R2} - t_0$$

To compare chromatograms that are recorded with columns of different lengths and internal diameters, as well as different flow rates, the retention time is converted into a dimensionless capacity factor k' .

$$k'_1 = \frac{t_{R1} - t_0}{t_0} \text{ bzw. } k'_2 = \frac{t_{R2} - t_0}{t_0}$$

The relative retention α , also known as the separation factor, describes the ability of a chromatographic system (stationary and mobile phase) to distinguish between two compounds. This

is calculated from the rate of the capacity factors of the substances, where the figure in the denominator is the reference compound.

$$\alpha = \frac{k'_2}{k'_1}$$

The resolution R is a measure for the efficiency of the column to separate two substances. Besides the retention time t_R the peak width at half height $w_{1/2}$ is also included.

$$R = 1.18 \cdot \frac{t_{R2} - t_{R1}}{(w_{1/2})_2 + (w_{1/2})_1}$$

For practical reasons the peak symmetry is calculated at 10 % of peak height. Ideally symmetry should be 1, i. e. $A = B$. Values > 1 indicate peak tailing, while values < 1 indicate peak fronting.

$$\text{Peak symmetry} = \frac{B}{A}$$

Instead of the mobile phase volumetric flow rate [mL/min], which is controlled at the HPLC instrument, it is advantageous to use the linear velocity u [cm/sec]. The linear velocity is independent of the column cross section and proportional to the pressure drop in the column. The linear velocity can be calculated by means of the dead time, where L is the column length in cm and t_0 the dead time in sec.

$$u = \frac{L}{t_0}$$

The quality of a column packing is determined through the number of theoretical plates N . High N values indicate a high capability to separate complex sample mixtures.

$$N = 5.54 \cdot \left(\frac{t_{R1}}{w_{1/2}} \right)^2$$

The value of the height equivalent to a theoretical plate HEPT is a criterion for the quality of a column. HEPT, is the length, in which the chromatographic equilibrium between mobile and stationary phase has been adjusted once. Its value depends on the particle size, the flow velocity, the mobile phase viscosity and especially on the packing quality. Small HEPT values, meaning a large number of theoretical plates N , facilitate the column to separate complex sample mixtures.

$$H = \frac{L}{N}$$

The Van Deemter equation shows the dependence of the HEPT on the velocity u .

$$H = A + \frac{B}{u} + C \cdot u$$

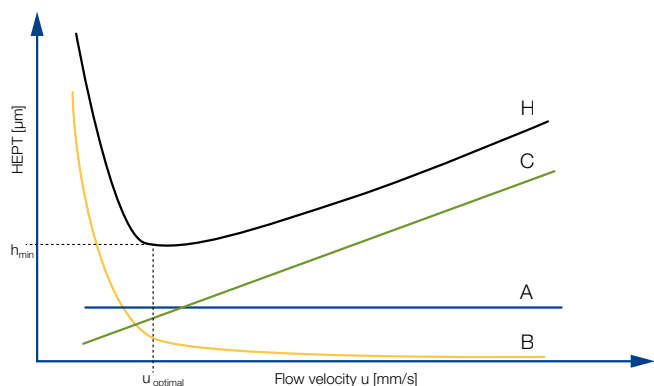
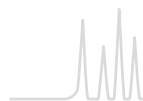

A term = eddy-diffusion, B term = longitudinal diffusion coefficient, C term = mass transfer coefficient, H = HEPT = height equivalent to a theoretical plate

The A term, also called eddy-diffusion, is a function of the particle size, the B term a function of the diffusion coefficient of the substance in the mobile phase and the C term the retardation

of a substance by the interface between stationary and mobile phase. In the point of intersection of h_{min} and u_{opt} the optimal separation efficiency for a column with high peak symmetry for the separated substances is obtained.

Column quality

Each HPLC/UHPLC column of MACHEREY-NAGEL is individually tested according to the most important characteristic parameters in quality control and the results are documented in a certificate of analysis.

Detailed information of the particular properties of the high-purity silica phases NUCLEODUR®, of the established standard silica NUCLEOSIL® and the modern Core-Shell material NUCLEOSHELL® as well as phases for special separations and the equivalent HPLC- and UHPLC-columns can be found on the following pages.

Strict quality specifications Outstanding reliability

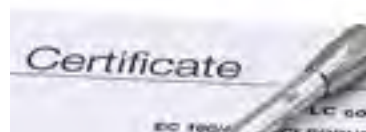

Highest production standard

- Our facilities are ISO 9001 certified
- Perfect reproducibility from batch-to-batch and within each lot
- Individually tested columns, supplied with test chromatogram and conditions



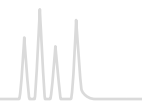

USP specification of MN HPLC phases

Code	Specification	MN HPLC Phases	Page
USP L1	octadecyl silane chemically bonded to porous silica particles 1.5 to 10 µm diameter, or monolithic silica gel	NUCLEODUR® C ₁₈ ec	181
		NUCLEODUR® C ₁₈ Gravity	158
		NUCLEODUR® C ₁₈ Gravity-SB	162
		NUCLEODUR® C ₁₈ HTec	178
		NUCLEODUR® C ₁₈ Isis	164
		NUCLEODUR® C ₁₈ Pyramid	166
		NUCLEODUR® PolarTec	168
		NUCLEODUR® Sphinx RP	176
		NUCLEOSHELL® RP 18	200
		NUCLEOSHELL® RP 18plus	202
		NUCLEOSIL® C ₁₈	220
		NUCLEOSIL® C ₁₈ AB	220
		NUCLEOSIL® C ₁₈ HD	220
		NUCLEOSIL® Nautilus	221
NUCLEOSIL® C ₁₈ MPN	250		
NUCLEOSIL® C ₁₈ PPN	251		
USP L3	porous silica particles, 1.5 to 10 µm diameter, or monolithic silica gel	NUCLEODUR® SiOH	190
		NUCLEOSIL® SiOH	230
USP L7	octyl silane chemically bonded to totally porous silica particles, 1.8 to 10 µm diameter	NUCLEODUR® C ₈ ec	181
		NUCLEODUR® C ₈ Gravity	158
		NUCLEOSIL® C ₈	224
		NUCLEOSIL® C ₈ HD	224
USP L8	an essentially monomolecular layer of aminopropyl silane chemically bonded to totally porous silica gel support, 1.5 to 10 µm diameter	NUCLEODUR® NH ₂ /NH ₂ -RP	188
		NUCLEOSIL® Carbohydrate	254
		NUCLEOSIL® NH ₂ /NH ₂ -RP	227
USP L9	irregular or spherical, totally porous silica gel having a chemically bonded, strongly acidic cation-exchange coating, 3 to 10 µm diameter	NUCLEOSIL® SA	229
USP L10	nitrile groups chemically bonded to porous silica particles, 1.5 to 10 µm diameter	NUCLEODUR® CN / CN-RP NUCLEOSIL® CN / CN-RP	186 228
USP L11	phenyl groups chemically bonded to porous silica particles, 1.5 to 10 µm diameter	NUCLEODUR® Phenyl-Hexyl	170
		NUCLEODUR® π ²	172
		NUCLEOSHELL® Phenyl-Hexyl	207
		NUCLEODUR® Sphinx RP	176
		NUCLEOSIL® C ₆ H ₅	226
USP L14	silica gel having a chemically bonded, strongly basic quaternary ammonium anion-exchange coating, 5 to 10 µm diameter	NUCLEOSIL® SB	229
USP L16	dimethylsilane chemically bonded to porous silica particles, 5 to 10 µm diameter	NUCLEOSIL® C ₂	225
USP L17	strong cation-exchange resin consisting of sulfonated cross-linked PS/DVB copolymer in the H form, 6 to 12 µm diameter	NUCLEOGEL® ION 300 OA	256
		NUCLEOGEL® SUGAR 810 H	255
USP L19	strong cation-exchange resin consisting of sulfonated cross-linked PS/DVB copolymer in the Ca form, 5 to 15 µm particle size	NUCLEOGEL® SUGAR 810 Ca	255
		NUCLEOGEL® SUGAR Ca	256
USP L20	dihydroxypropane groups chemically bonded to porous silica particles, 5 to 10 µm diameter	NUCLEOSIL® OH (Diol)	226
USP L21	a rigid, spherical styrene-divinylbenzene copolymer, 5 to 10 µm diameter	NUCLEOGEL® RP	252
USP L22	a cation-exchange resin made of porous polystyrene gel with sulfonic acid groups, about 10 µm in size	NUCLEOGEL® SCX	247
USP L23	an anion-exchange resin made of porous polymethacrylate or polyacrylate gel with quaternary ammonium groups, about 10 µm in size	NUCLEOGEL® SAX	247
USP L26	butyl silane chemically bonded to totally porous silica particles, 5 to 10 µm diameter	NUCLEODUR® C ₄ ec	248
		NUCLEOSIL® C ₄	225
		NUCLEOSIL® C ₄ MPN	250
USP L32	a chiral ligand-exchange resin packing · L-proline copper complex covalently bonded to irregular shaped silica particles, 5 to 10 µm diameter	NUCLEOSIL® CHIRAL-1	242
USP L34	strong cation-exchange resin consisting of sulfonated cross-linked PS-DVB copolymer in the Pb form, 5 to 7 µm particle size	NUCLEOGEL® SUGAR Pb	256
USP L36	a 3,5-dinitrobenzoyl derivative of L-phenylglycine covalently bonded to 5 µm aminopropyl silica	NUCLEOSIL® CHIRAL-3	243
USP L40	cellulose tris-(3,5-dimethylphenylcarbamate) coated porous silica particles, 5 to 20 µm diameter	NUCLEOCEL DELTA	240



USP specification of MN HPLC phases

Code	Specification	MN HPLC Phases	Page
USP L43	pentafluorophenyl groups chemically bonded to silica particles by a propyl spacer, 1.5 to 10 µm diameter	NUCLEODUR® PFP	174
		NUCLEOSHELL® PFP	212
USP L45	beta-cyclodextrin bonded to porous silica particles, R,S-hydroxypropyl ether derivative, 3 to 10 µm diameter	NUCLEODEX β-OH, β-PM	238
USP L58	strong cation-exchange resin consisting of sulfonated cross-linked PS/DVB copolymer in the Na form, 6 to 30 µm diameter	NUCLEOGEL® SUGAR Na	256
USP L60	spherical porous silica gel, particle size of 10 µm diameter or smaller, the surface of which has been covalently modified with alkyl amide groups and endcapped	NUCLEODUR® PolarTec	168
		NUCLEOSIL® C ₁₈ Nautilus	220
USP L75	A chiral-recognition protein, bovine serum albumin (BSA), chemically bonded to silica particles, about 7 µm in diameter, with a pore size of 300 Angstrom	RESOLVOSIL BSA-7	241
USP L118	Aqueous polymerized C ₁₈ groups on silica particles, 1.2 to 5 µm in diameter	NUCLEODUR® C ₁₈ PAH	234
		NUCLEOSIL® C ₁₈ PAH	236

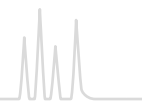

NUCLEODUR[®] is a fully synthetic type B silica (silica of 3rd generation) offering highly advanced physical properties like totally spherical particle shape, outstanding surface micro-structure, high pressure stability and low metal content.

NUCLEODUR[®] as a state-of-the-art silica is the ideal base material for modern HPLC phases. It is the result of MACHEREY-NAGEL's pioneering research in chromatography for more than 40 years.

In RP liquid chromatography the efficiency of the packing is strongly affected by the quality of the base silica itself. Shortcomings in the surface geometry of the particles or metal contaminants are the main reasons for inadequate coverage with the covalently bonded alkylsilanes in the subsequent derivatization steps. It is well known, that poor surface coverage and, in consequence, high activity of residual free silanols often results in peak tailing or adsorption, particularly with basic compounds.

Particle shape and surface symmetry

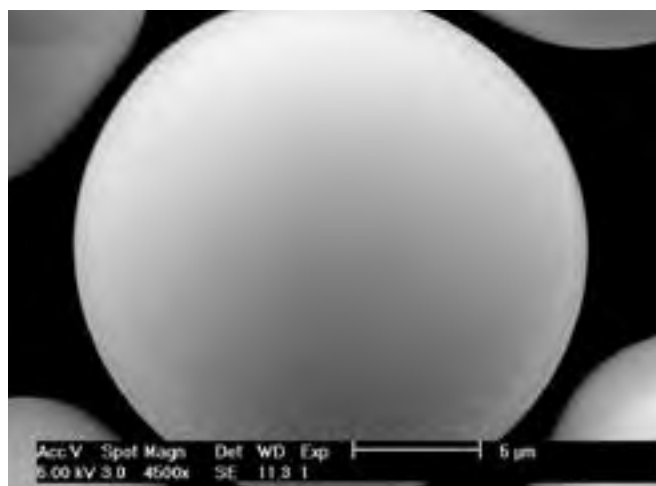

NUCLEODUR[®] silicas are synthesized in a unique and carefully controlled manufacturing process which provides silica particles, which are totally spherical. The picture shows the outstanding smoothness of the NUCLEODUR[®] surface.

Purity

As already mentioned above, a highly pure silica is required for achieving symmetric peak shapes and maximum resolution. Inclusions of e.g., iron or alkaline earth metal ions on the silica surface are largely responsible for the unwanted interactions with ionizable analytes e.g., amines or phenolic compounds.

NUCLEODUR[®] is virtually free of metal impurities and low acidic surface silanols. Elemental analysis data of NUCLEODUR[®] 5 µm measured by AAS are listed below.

Elementary analysis (metal ions) of NUCLEODUR[®] 100 - 5

Aluminum	< 5	ppm
Iron	< 5	ppm
Sodium	< 5	ppm
Calcium	< 10	ppm
Titanium	< 1	ppm
Zirconium	< 1	ppm
Arsenic	< 0.5	ppm
Mercury	< 0.05	ppm

Pressure stability

The totally spherical and 100 % synthetic silica gel exhibits an outstanding mechanical stability, even at high pressures and elevated eluent flow rates. In addition, after several cycles of repeated packing, no significant drop in pressure can be observed. The latter is of prime importance for preparative and process-scale applications.

NUCLEODUR[®] silica is available with two pore sizes – 110 Å pore size as standard material and as 300 Å widepore material for the separation of biomolecules, like peptides and proteins.

Physical data of NUCLEODUR[®]

	Standard	Widepore
Pore size	110 Å	300 Å
Surface area (BET)	340 m ² /g	100 m ² /g
Pore volume	0.9 mL/g	0.9 mL/g
Density	0.47 g/mL	0.47 g/mL

NUCLEODUR[®] modifications

Several different surface modifications based on NUCLEODUR[®] silica have been developed over the last years providing a full range of specified HPLC phases and an ideal tool for every separation.

For a summary of important properties of our NUCLEODUR[®] phases please see page 152.



1.8 µm particles for increased separation efficiency

Key features

- Decrease of analysis time (ultra fast HPLC)
- Shorter columns with high separation efficiency and significant improvement of resolution and detection sensitivity
- Suitable for LC/MS due to low bleeding characteristics

Fractionation

- NUCLEODUR® 1.8 µm particles are fractionated to limit the increase in back pressure.

Advantages of 1.8 µm particle size

Miniaturization started in the early stage of HPLC with the reduction of particle size from 10 µm via 7 µm to standard 5 µm – still the most used particle diameter in analytical HPLC – to 3 µm spherical particles. With the introduction of 1.8 µm NUCLEODUR® particles researchers have turned over a new leaf in HPLC column technology, featuring extraordinary improvements in terms of plate numbers, column efficiency and resolution compared with 3 µm particles.

Increased separation efficiency by higher number of theoretical plates (N):

- 50 × 4.6 mm NUCLEODUR® C₁₈ Gravity
- 3 µm: N ≥ 100 000 plates/m (h-value ≤ 10)
- 1.8 µm: N ≥ 166 667 plates/m (h-value ≤ 6)

Increase of the plate number by ~ 67 % offers the possibility of using shorter columns with equal plate number resulting in a decrease of analysis time.

Significant improvement in resolution

$$R_s = \frac{\sqrt{N}}{4} \left(\frac{\alpha - 1}{\alpha} \right) \left(\frac{k'_i}{k'_i + 1} \right)$$

R_s = resolution, α = selectivity (separation factor), k'_i = retention
N = plate number with N ∝ 1/d_p, d_p = particle diameter

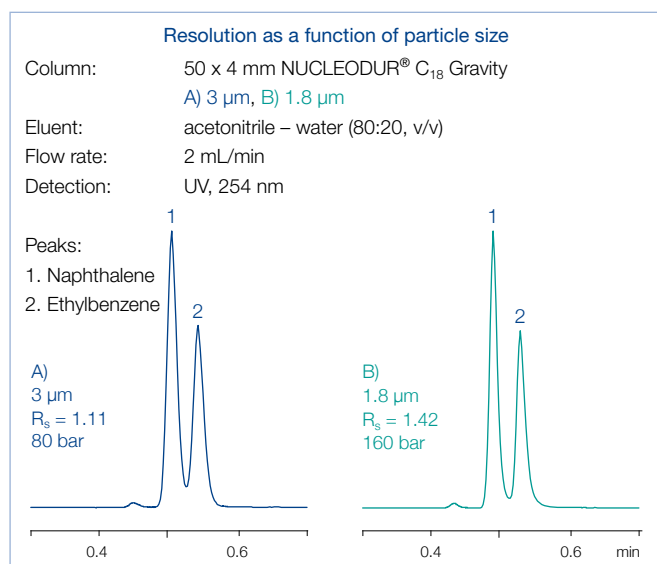

Availability

- The following NUCLEODUR® phases are available in 1.8 µm:
C₁₈ Gravity, C₈ Gravity, C₁₈ Gravity-SB, C₁₈ Isis,
C₁₈ Pyramid, PolarTec, Phenyl-Hexyl, PFP, Sphinx RP,
C₁₈ HTec and HILIC

Use of 1.8 µm instead of 3 µm particles leads to an increase of resolution by a factor of 1.29 (29 %) since the resolution is inversely proportional to the square root of the particle size.

Column back pressure

Due to the smaller particles the back pressure will increase according to

$$\Delta p = \frac{\Phi \cdot L_c \cdot \eta \cdot u}{d_p^2}$$

Δp = pressure drop, Φ = flow resistance (non-dimensional), L_c = column length, η = viscosity, u = linear velocity, d_p = particle diameter

The high sphericity of the NUCLEODUR® particles and the very narrow particle size distribution allow to keep the back pressure on a moderate level.

Comparison of back pressures

Eluent 100 % methanol, flow rate 1.5 mL/min
temperature 22 °C, column dimensions 50 × 4.6 mm

	NUCLEODUR® C ₁₈ Gravity	Competitor
3 µm	70 bar	–
1.8 µm	130 bar	170 bar

Higher flow rates and shorter run times

The optimal flow rate for 1.8 µm particles is higher than for 3 and 5 µm particles (see figure – the flow rate should be at the van Deemter minimum).

Van Deemter curves

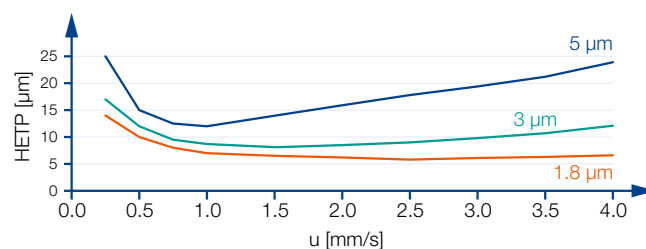

Technical requirements







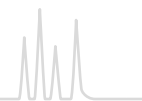



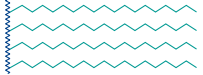

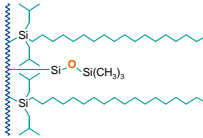

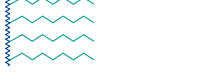
To gain best results with 1.8 µm particles certain technical demands must be met including pumps for flow rates of 2–3 mL with pressures of 250–1000 bar, minimized dead volume, and fast data recording.

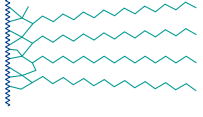

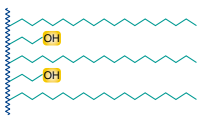
NUCLEODUR[®] phase overview

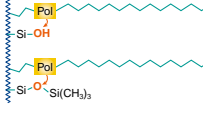

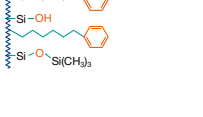
Overview of NUCLEODUR[®] HPLC phases

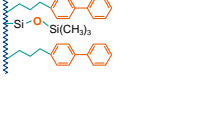
Phase	Specification	Page	Characteristic*	Stability	Structure
 C ₁₈ Gravity	octadecyl, high density coating, multi-endcapping 18 % C · USP L1	158	A ●●●●● B ●●●●● C ●●●●●	pH 1 – 11, suitable for LC/MS	NUCLEODUR [®] (Si-O) _n 
 C ₁₈ Gravity-SB	octadecyl (monomeric), extensive endcapping 13 % C · USP L1	162	A ●●●●● B ●●●●● C -	pH 1 – 9, suitable for LC/MS	NUCLEODUR [®] (Si-O) _n 
 C ₈ Gravity	octyl, high density coating, multi-endcapping 11 % C · USP L7	158	A ●●●●● B ●●●●● C ●●●●●	pH 1 – 11, suitable for LC/MS	NUCLEODUR [®] (Si-O) _n 
 C ₁₈ Isis	octadecyl phase with specially crosslinked surface modification endcapping 20 % C · USP L1	164	A ●●●●● B ●●●●● C ●●●●●	pH 1 – 10, suitable for LC/MS	NUCLEODUR [®] (Si-O) _n 
 C ₁₈ Pyramid	octadecyl with polar endcapping 14 % C · USP L1	166	A ●●●●● B ●●●●● C ●●●●●	stable in 100 % aqueous eluent, pH 1 – 9, suitable for LC/MS	NUCLEODUR [®] (Si-O) _n 
 PolarTec	octadecyl with embedded polar group 17 % C · USP L1 and L60	168	A ●●●●● B ●●●●● C ●●●●●	stable in 100 % aqueous eluent, pH 1 – 9, suitable for LC/MS	NUCLEODUR [®] (Si-O) _n 
 Phenyl-Hexyl	phenylhexyl, multi-endcapping 10 % C · USP L11	170	A ●●●●● B ●●●●● C ●●●●●	pH 1 – 10, suitable for LC/MS	NUCLEODUR [®] (Si-O) _n 
 π ²	biphenylpropyl, multi-endcapping 17 % C · USP L11	172	A ●●●●● B ●●●●● C ●●●●●	pH 3 – 10	NUCLEODUR [®] (Si-O) _n 

* A = ● hydrophobic selectivity, B = ● polar / ionic selectivity, C = ● steric selectivity

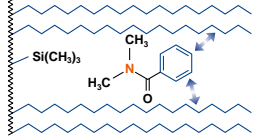
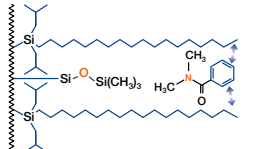
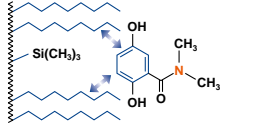
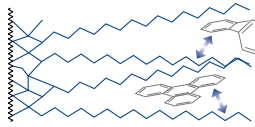
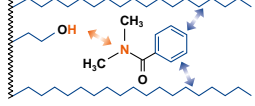
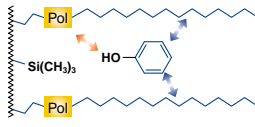
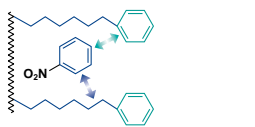
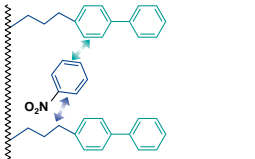

Application	Similar phases**	Interactions · retention mechanism
in general compounds with ionizable functional groups such as basic pharmaceuticals and pesticides	NUCLEOSIL [®] C ₁₈ HD Xterra [®] RP18 / MS C18; Luna [®] C18(2), Gemini [®] , Synergi [®] Max RP; Zorbax [®] Extend-C18; Inertsil [®] ODS III; Purospher [®] STAR RP-18; Hypersil [™] BDS	hydrophobic (van der Waals interactions) 
overall sophisticated analytical separations, especially for polar compounds, e. g., antibiotics, water-soluble vitamins, organic acids	–	hydrophobic (van der Waals interactions) with additional polar interactions 
like C ₁₈ Gravity, however, generally shorter retention times for nonpolar compounds	NUCLEOSIL [®] C ₈ HD Xterra [®] RP8 / MS C8; Luna [®] C8; Zorbax [®] Eclipse XDB-C8	hydrophobic (van der Waals interactions) 
high steric selectivity, thus suited for separation of positional and structural isomers, planar / nonplanar molecules	NUCLEOSIL [®] C ₁₈ AB Inertsil [®] ODS-P; Pro C18 RS	steric and hydrophobic 
basic pharmaceuticals, very polar compounds, organic acids	Aqua, Synergi [®] Hydro-RP; AQ; Atlantis [®] dC18; Polaris [®] C18-A	hydrophobic and polar (H bonds) 
basic pharmaceuticals, organic acids, pesticides, amino acids, water-soluble vitamins	NUCLEOSIL [®] C ₁₈ Nautilus ProntoSIL [®] C18 AQ, Zorbax [®] Bonus-RP, Polaris [®] Amide-C18; Ascentis [®] RP Amide, SymmetryShield [™] RP18; SUPELCOSIL [™] LC-ABZ ⁺ ; HyPURITY [™] ADVANCE; ACCLAIM Polar AD.II	hydrophobic and polar (H bonds) 
aromatic and unsaturated compounds, polar compounds like pharmaceuticals, antibiotics	Luna [®] Phenyl-Hexyl; Zorbax [®] Eclipse Plus Phenyl-Hexyl; Kromasil [®] Phenyl-Hexyl	π-π and hydrophobic 
aromatic and unsaturated compounds, polar compounds like pharmaceuticals, antibiotics	Pinnacle [®] DB Biphenyl; Ultra Biphenyl	π-π and hydrophobic 







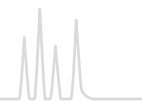





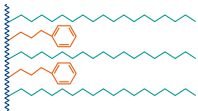

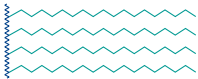
** phases which provide a similar selectivity based on chemical and physical properties

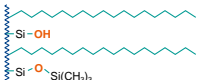

NUCLEODUR® phase overview

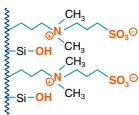

Overview of NUCLEODUR® HPLC phases

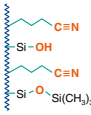
Phase	Specification	Page	Characteristic*	Stability	Structure
 PFP	pentafluorophenylpropyl, multi-endcapping 8% C · USP L43	174	A ●● B ●●●● C ●●●●	pH 1–9, suitable for LC/MS	NUCLEODUR® (Si-O) _{2/n} 
 Sphinx RP	bifunctional, balanced ratio of propylphenyl and octadecyl, endcapping 15% C · USP L1 and L11	176	A ●●● B ●●●● C ●	pH 1–10, suitable for LC/MS	NUCLEODUR® (Si-O) _{2/n} 
 C ₁₈ HTec	octadecyl, high density coating, high capacity, multi-endcapping 18% C · USP L1	178	A ●●●●● B ●● C ●●●	pH 1–11, suitable for LC/MS	NUCLEODUR® (Si-O) _{2/n} 
 C ₁₈ ec	octadecyl, medium density, endcapping available in 110 Å and 300 Å pore size 17.5% / 4% C · USP L1	181	A ●●●●● B ●● C ●●●●	pH 1–9	NUCLEODUR® (Si-O) _{2/n} 
 C ₈ ec	octyl, medium density, endcapping 10.5% C · USP L7	181	A ●●● B ●●● C ●●●●	pH 1–9	NUCLEODUR® (Si-O) _{2/n} 
 C ₄ ec	butyl, medium density, endcapping, 300 Å pore size 2.5% C · USP L26	181	A ●● B ●●● C ●●●	pH 1–9	NUCLEODUR® (Si-O) _{2/n} 
 HILIC	zwitterionic ammonium – sulfonic acid phase 7% C	184	A ● B ●●●●● C -	pH 2–8.5	NUCLEODUR® (Si-O) _{2/n} 
 CN/CN-RP	cyano (nitrile) for NP and RP separations 7% C · USP L10	186	A ● B ●●●●● C -	pH 1–8, stable towards highly aqueous mobile phases	NUCLEODUR® (Si-O) _{2/n} 

* A = ● hydrophobic selectivity, B = ● polar / ionic selectivity, C = ● steric selectivity



NUCLEODUR[®] phase overview



Application	Similar phases**	Interactions · retention mechanism
aromatic and unsaturated compounds, halogen compounds, phenols, isomers, polar pharmaceuticals, antibiotics	ACQUITY [®] CSH Fluoro-Phenyl; Hypersil [™] GOLD PFP; Luna [®] PFP(2); Discovery [®] HS F5; Allure [®] PFP Propyl; Ultra II PFP Propyl	polar (H bond), dipole-dipole, π-π and hydrophobic
compounds with aromatic and multiple bond systems	no similar phases	π-π and hydrophobic
robust and well base deactivated C ₁₈ phase; all separation tasks with preparative potential	Xterra [®] RP18/MS C18/SunFire [™] C18; Luna [®] C18(2), Gemini [®] , Synergi [®] Max RP; Zorbax [®] Extend-C18; Inertsil [®] ODS III; Purospher [®] STAR RP-18; Hypersil [®] BDS	hydrophobic (van der Waals interactions)
robust C ₁₈ phase for routine analyses	NUCLEOSIL [®] C ₁₈ Spherisorb [®] ODS II; Symmetry [®] C18; Hypersil [®] ODS; Inertsil [®] ODS II; Kromasil [®] C18; LiChrospher [®] RP-18	hydrophobic (van der Waals interactions) some residual silanol interactions
robust C ₈ phase for routine analyses	NUCLEOSIL [®] C ₈ ec/C ₈ Spherisorb [®] C8; Symmetry [®] C8; Hypersil [®] MOS; Kromasil [®] C8; LiChrospher [®] RP-8	hydrophobic (van der Waals interactions) some residual silanol interactions
biological macromolecules like proteins or peptides	Jupiter [®] C4; ACE [®] C4	hydrophobic (van der Waals interactions) some residual silanol interactions
hydrophilic compounds such as polar organic acids and bases, polar natural compounds	Sequant [™] ZIC [®] -HILIC; Obelisc [™]	ionic / hydrophilic and electrostatic
polar organic compounds (basic drugs), molecules containing π-electron systems	NUCLEOSIL [®] CN / CN-RP	π-π and polar (H bond), hydrophobic



** phases which provide a similar selectivity based on chemical and physical properties

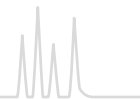

NUCLEODUR[®] phase overview

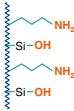

Overview of NUCLEODUR[®] HPLC phases

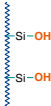
Phase	Specification	Page	Characteristic*	Stability	Structure
 NH ₂ /NH ₂ -RP	aminopropyl for NP and RP separations 2.5% C · USP L8	188	A ● B ●●●● C -	pH 2–8, stable towards highly aqueous mobile phases	NUCLEODUR [®] (Si-O) ₂ n 
 SiOH	unmodified high purity silica · USP L3	190	A - B - C -	pH 2–8	NUCLEODUR [®] (Si-O) ₂ n 

* A = ● hydrophobic selectivity, B = ● polar / ionic selectivity, C = ● steric selectivity



NUCLEODUR[®] phase overview



Application	Similar phases**	Interactions · retention mechanism
sugars, sugar alcohols and other hydroxy compounds, DNA bases, polar compounds in general	NUCLEOSIL [®] NH ₂ /NH ₂ -RP	polar / ionic and hydrophobic
polar compounds in general	NUCLEOSIL [®] SiOH	polar / ionic

** phases which provide a similar selectivity based on chemical and physical properties

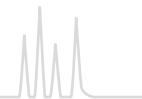

NUCLEODUR[®] C₁₈ Gravity · C₈ Gravity nonpolar high density phase · USP L1 (C₁₈) · USP L7 (C₈)

★ Key feature

- Suitable for LC/MS and HPLC at pH extremes (pH 1 – 11)
- Superior base deactivation
- Ideal for method development

🔧 Technical data

- Available as octadecyl (C₁₈) and octyl (C₈), multi-encapped
- Pore size 110 Å; particle sizes 1.8 µm, 3 µm and 5 µm for C₁₈, 1.8 and 5 µm for C₈; 7, 10, 12 and 16 µm particles for preparative purposes on request
- Carbon content 18 % for C₁₈, 11 % for C₈

✓ Recommended application

- Overall sophisticated analytical separations
- Compound classes separated include pharmaceuticals, e. g., analgesics, anti-inflammatory drugs, antidepressants; herbicides; phytopharmaceuticals; immunosuppressants

Base deactivation

NUCLEODUR[®] C₁₈ Gravity and NUCLEODUR[®] C₈ Gravity are based on the ultrapure NUCLEODUR[®] silica. Derivatization generates a homogeneous surface with a high density of bonded silanes (~18 % C for C₁₈, ~11 % C for C₈). Thorough endcapping suppresses any unwanted polar interactions between the silica surface and the sample, which makes “Gravity” particularly suitable for the separation of basic and other ionizable analytes. Even strongly basic pharmaceuticals like amitriptyline are eluted without tailing under isocratic conditions. For a discussion of the different retention behavior of C₁₈ phases compared to C₈ phases see page 182.

Enhanced pH stability

One major disadvantage of silica stationary phases is limited stability at strongly acidic or basic pH. Cleavage of the siloxane bonding by hydrolysis, or dissolution of the silica will rapidly lead to a considerable loss in column performance. Conventional RP phases are usually not recommended to be run with mobile phases at pH > 8 or pH < 2 for extended periods of time. The special surface bonding technology and the low concentration of trace elements of NUCLEODUR[®] C₁₈ and C₈ Gravity allow for use at an expanded pH range from pH 1 to 11.

Benefits of enhanced pH stability

An expanded pH range is often required in method development. Many nitrogen containing compounds like basic drugs are protonated at acidic or neutral pH and exhibit poor retention on a standard C₁₈ phase. The retention behavior can be improved by working at a higher pH, where the analyte is no longer protonated, but formally neutrally charged, as a rule between pH 9–10. For acidic analytes it is exactly in inverse proportion, maximum retention can be attained at low pH.

Surface silanols at different pH values

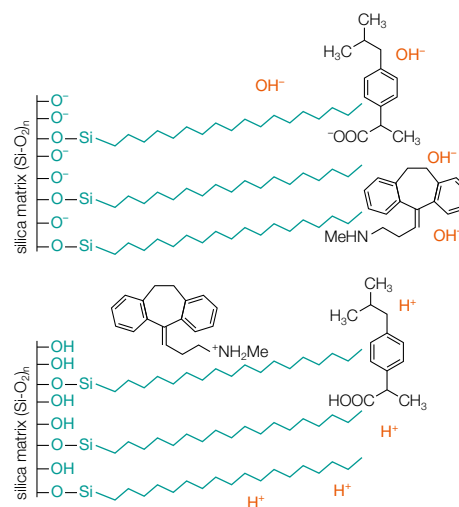

The figure above shows the extent of protonation of surface silanols and of two exemplary analytes at acidic and alkaline pH. The following graph explains the general correlation between retention and pH.

Correlation between retention and pH for basic and acidic compounds

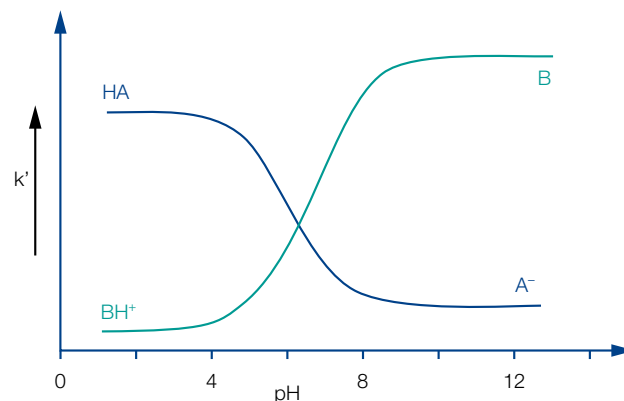



An example how selectivity can be controlled by pH is the separation of the acid ketoprofen, the base lidocaine and benzamide. Under acidic conditions the protonated lidocaine is eluted very fast due to lack of sufficiently strong hydrophobic interactions between analyte and C₁₈ chains, while the formally neutral keto- profen is eluted after about 3 min. However, at pH 10 a reversal of the elution order, with a visibly longer retention time for the basic lidocaine, is observed.

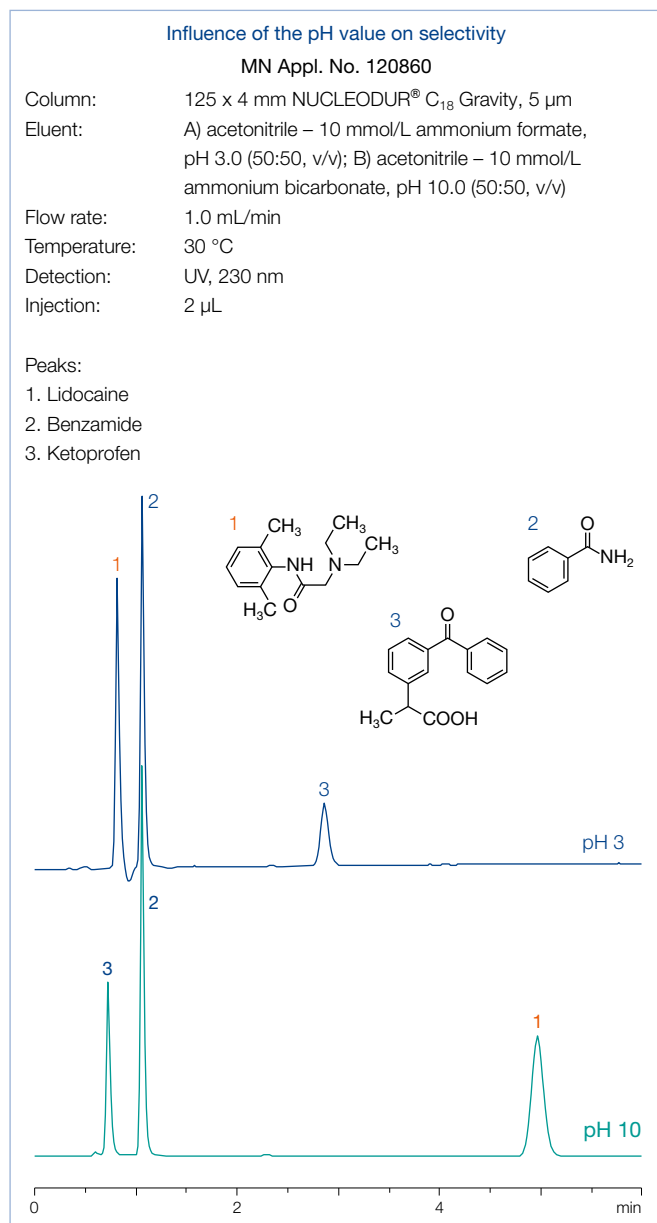

As mentioned above, pH stability of the stationary phase can be helpful for improving selectivity in method development. The following figure shows the separation of 4 basic drugs under acidic and basic conditions.

At pH 2.5 the protonated analytes exhibit poor retention (early elution) and in addition an inadequate resolution for papaverine and noscapine, whilst the formally non ionized molecules can be baseline separated due to the better retention pattern at alkaline pH.

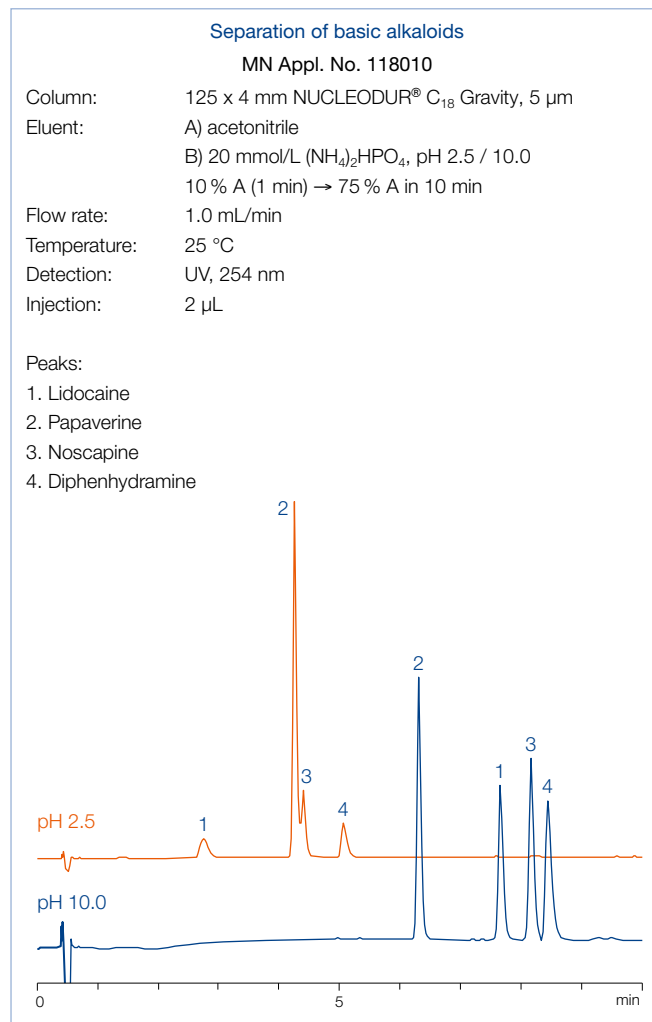

The following chromatogram demonstrates the stability of NUCLEODUR® C₁₈ Gravity under alkaline conditions. The ultra- pure Gravity with its unique high density surface bonding technology withstands strong alkaline mobile phase conditions.

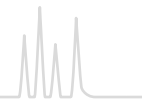

Stability of NUCLEODUR® C₁₈ Gravity at pH 11

MN Appl. No. 120850

Column: 50 x 4.6 mm NUCLEODUR® C₁₈ Gravity, 5 µm
 Eluent: methanol – water – ammonia (20:80:0.5, v/v/v), pH 11
 Flow rate: 1.3 mL/min
 Temperature: 30 °C
 Detection: UV, 254 nm
 Injection: 2.0 µL

Peaks:
 1. Theophylline
 2. Caffeine

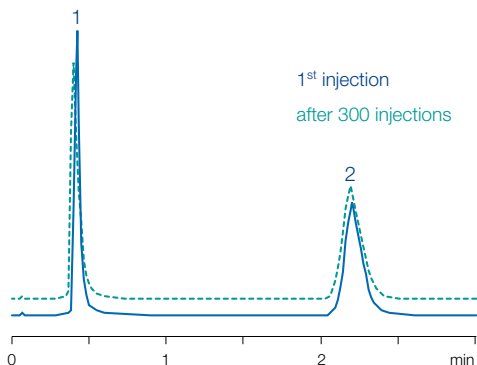

Even after 300 injections no loss of column efficiency – identified, e. g., by peak broadening or decrease in retention times – could be observed.

Under alkaline conditions dissolution of the silica support is possible, resulting in dead volume and thus peak broadening. It is worth mentioning, that this phenomenon also depends on type and concentration of buffers, as well as on the temperature. It is well known that the use of phosphate buffers, particularly at

elevated temperatures, can reduce column lifetime even at moderate pH. If possible, phosphate buffers should be replaced by less harmful alternatives.

The following chromatograms show the excellent column stability of NUCLEODUR® C₁₈ Gravity in acidic conditions. Retention times of all three compounds in the column performance test remain consistent and virtually unchanged, even after the column is run with 5000 mL eluent. Due to the extremely stable surface modification, no cleavage of the Si-O-Si bonding occurs, column deterioration is therefore successfully prevented.

Stability of NUCLEODUR® C₁₈ Gravity at pH 1.5

MN Appl. No. 120840

Column: 125 x 4 mm NUCLEODUR® C₁₈ Gravity, 5 µm
 Eluent: acetonitrile – 1 % TFA in water (50:50, v/v), pH 1.5
 Flow rate: 1.0 mL/min
 Temperature: 30 °C
 Detection: UV, 230 nm
 Injection: 5 µL

Peaks: 1. Pyridine, 2. Toluene, 3. Ethylbenzene

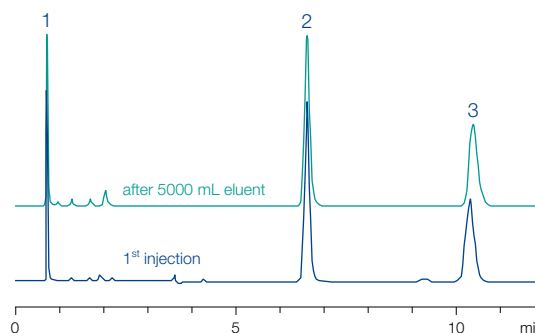



Eluent in column acetonitrile – water



ID	Length →							
	30 mm	50 mm	75 mm	100 mm	125 mm	150 mm	250 mm	
NUCLEODUR® C₁₈ Gravity, 1.8 µm; octadecyl phase, particle size 1.8 µm, 18 % C · UHPLC								
Analytical EC columns								
	2 mm	760078.20	760079.20	760071.20	760076.20		760075.20	
	3 mm	760078.30	760079.30		760076.30			
	4 mm	760078.40	760079.40		760076.40			
	4.6 mm	760078.46	760079.46		760076.46			
EC guard columns*		4 x 2 mm: 761901.20		4 x 3 mm: 761901.30				
NUCLEODUR® C₁₈ Gravity, 3 µm; octadecyl phase, particle size 3 µm, 18 % C								
Analytical EC columns								
	2 mm		760080.20		760084.20	760081.20	760083.20	760082.20
	3 mm		760080.30		760084.30	760081.30	760083.30	760082.30
	4 mm		760080.40		760084.40	760081.40	760083.40	760082.40
	4.6 mm		760080.46	760086.46	760084.46	760081.46	760083.46	760082.46
EC guard columns*		4 x 2 mm: 761902.20		4 x 3 mm: 761902.30				



Eluent in column acetonitrile – water

ID	Length →						
	30 mm	50 mm	75 mm	100 mm	125 mm	150 mm	250 mm
NUCLEODUR® C₁₈ Gravity, 5 µm; octadecyl phase, particle size 5 µm, 18 % C							
Analytical EC columns							
	2 mm	760102.20		760104.20	760100.20	760103.20	760101.20
	3 mm	760102.30		760104.30	760100.30	760103.30	760101.30
	4 mm	760102.40		760104.40	760100.40	760103.40	760101.40
	4.6 mm	760102.46	760106.46	760104.46	760100.46	760103.46	760101.46
EC guard columns*		4 × 2 mm: 761903.20		4 × 3 mm: 761903.30			
Preparative VarioPrep columns							
	10 mm	762103.100			762109.100		762113.100
	21 mm	762103.210			762109.210		762113.210
	32 mm						762113.320
	40 mm					762100.400	762113.400
VP guard columns***		10 × 8 mm: 762160.80		10 × 16 mm: 762160.160		15 × 32 mm: 762163.320	
NUCLEODUR® C₁₈ Gravity, 10 µm; octadecyl phase, particle size 10 µm, 18 % C							
Preparative VarioPrep columns							
	21 mm						762250.210
	40 mm						762250.400
VP guard columns**				10 × 16 mm: 762160.160		15 × 32 mm: 762163.320	

Eluent in column acetonitrile – water

ID	Length →						
	30 mm	50 mm	75 mm	100 mm	125 mm	150 mm	250 mm
NUCLEODUR® C₈ Gravity, 1.8 µm; octyl phase, particle size 1.8 µm, 11 % C · UHPLC							
Analytical EC columns							
	2 mm	760756.20	760755.20	760760.20	760757.20		760759.20
	3 mm	760756.30	760755.30		760757.30		
	4 mm	760756.40	760755.40		760757.40		
	4.6 mm	760756.46	760755.46		760757.46		
EC guard columns*		4 × 2 mm: 761905.20		4 × 3 mm: 761905.30			
NUCLEODUR® C₈ Gravity, 5 µm; octyl phase, particle size 5 µm, 11 % C							
Analytical EC columns							
	2 mm	760750.20		760754.20	760751.20	760752.20	760753.20
	3 mm	760750.30		760754.30	760751.30	760752.30	760753.30
	4 mm	760750.40		760754.40	760751.40	760752.40	760753.40
	4.6 mm	760750.46	760749.46	760754.46	760751.46	760752.46	760753.46
EC guard columns*		4 × 2 mm: 761907.20		4 × 3 mm: 761907.30			
Preparative VarioPrep columns							
	10 mm	762081.100			762071.100		762070.100
	21 mm	762081.210			762071.210	762082.210	762070.210
VP guard columns**		10 × 8 mm: 762097.80		10 × 16 mm: 762097.160			
EC and VarioPrep columns in packs of 1, guard columns see below.							

Guard column systems

Guard columns for EC columns with ID	2 mm	3 mm	4 mm	4.6 mm	Guard column holder	
* Column Protection System (pack of)	EC	4/2 (3)	4/3 (3)	4/3 (3)	4/3 (3)	718966
Guard columns for VarioPrep columns with ID	8, 10 mm	16, 21 mm	32, 40 mm	≥ 50 mm		
** VP guard columns (pack of)	VP	10/8 (2)	10/16 (2)	15/32 (1)	15/50 (1)	
VP guard column holder		718251	718256	718253	718255	

For details of our column systems see page 258.

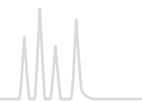

NUCLEODUR[®] C₁₈ Gravity-SB hydrophobic phase with polar selectivity · USP L1

★ Key feature

- Hydrophobic C₁₈ phase with distinct polar selectivity, ideal for method development, better retention of early eluting substances
- Excellent performance under highly aqueous conditions
- Suitable for LC/MS due to low bleeding characteristics

🔧 Technical data

- Monomeric octadecyl modification, extensive endcapping
- Pore size 110 Å; available particle sizes 1.8 µm, 3 µm and 5 µm; carbon content 13 %; pH stability 1 – 9

✓ Recommended application

- Overall sophisticated analytical separations, especially for polar compounds, e. g., antibiotics, water-soluble vitamins, organic acids

NUCLEODUR[®] C₁₈ Gravity-SB excels with a relatively high hydrophobicity – similar to C₁₈ Gravity – while simultaneously showing distinctive polar selectivity, without having polar embedded groups or polar endcapping. As a result the column displays better retention of early eluting analytes and high performance under strongly aqueous conditions. Additionally the column is suitable for LC/MS due to low bleeding characteristics. These features are achieved through side chains (isobutyl) of the monomeric C₁₈ phase.

In the TANAKA plot the NUCLEODUR[®] Gravity-SB shows similar hydrophobicity than the Gravity, however with a reduced capacity. The ion exchange capacity under basic conditions (pH 7.6) is high, which favors good retention of early eluting, polar substances.

Due to the broad selectivity and stability the base deactivated NUCLEODUR[®] C₁₈ Gravity-SB is versatile applicable, especially for polar analytes like nucleobases or pesticides the column shows good separation efficiency.

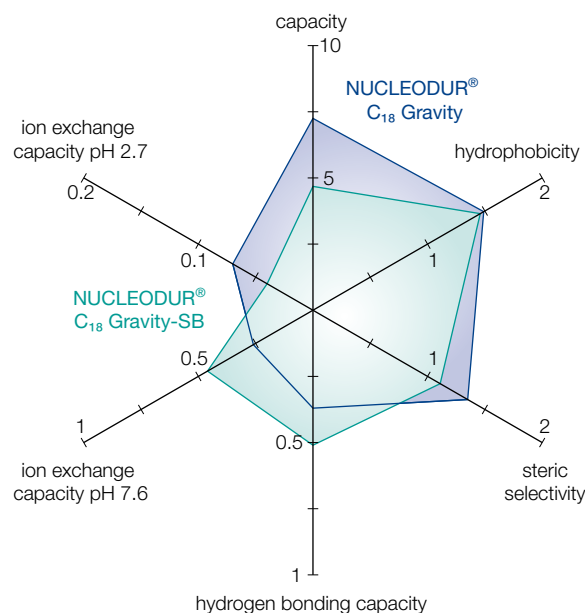

Pesticide mix (Ehrenstorfer, 17 components)

MN Appl. No. 127330

Column: EC 250/4.6 NUCLEODUR[®] C₁₈ Gravity-SB, 3 µm
 Eluent: A) acetonitrile
 B) 5 mmol/L NH₄Ac;
 10–37.5 % A in 50 min, 37.5–75 % A in 25 min
 Flow rate: 1.1 mL/min
 Temperature: 35 °C
 Detection: UV, 230 nm
 Injection: 3 µL

Peaks:

- | | | |
|-----------------------|------------------|-------------------|
| 1. Desethylatrazine | 7. Chlortoluron | 13. Metazachlor |
| 2. Metoxuron | 8. Atrazine | 14. Sebutylazin |
| 3. Hexazinone | 9. Monolinuron | 15. Terbutylazine |
| 4. Simazine | 10. Isoproturon | 16. Linuron |
| 5. Cyanazine | 11. Diuron | 17. Metolachlor |
| 6. Methabenzthiazuron | 12. Metobromuron | |

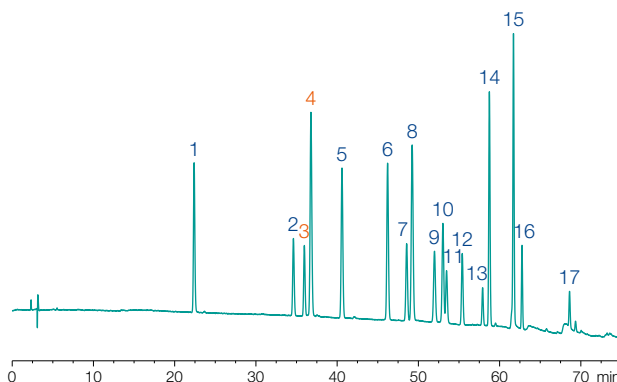

Good separation of the critical pair hexazinone/simazine



Selectivity comparison of nucleobases

MN Appl. No. 127270



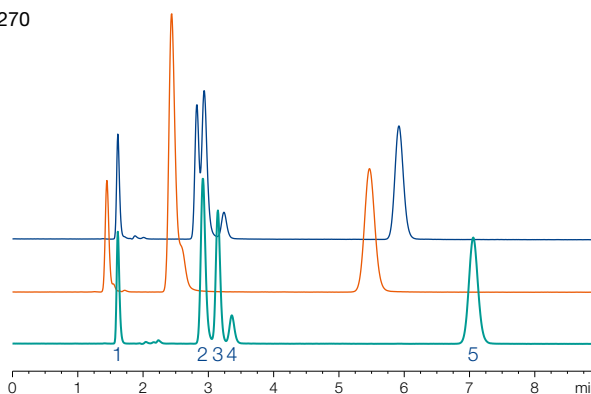

Columns: EC 150/4.6 mm
 NUCLEODUR® C₁₈ Gravity-SB, 5 µm
 NUCLEODUR® C₁₈ Gravity, 5 µm
 NUCLEODUR® C₁₈ Pyramid, 5 µm
 Eluent: 25 mmol/L KH₂PO₄, pH 3 – methanol (95:5, v/v)
 Flow rate: 1.0 mL/min, temperature: 20 °C
 Detection: UV, 220 nm, injection: 2.5 µL (1 mg/mL)

Peaks:
 1. Cytosine 4. Guanine
 2. Adenine 5. Thymine
 3. Uracil



Better resolution of early eluting analyte

Eluent in column acetonitrile – water

ID	Length → 30 mm	50 mm	75 mm	100 mm	125 mm	150 mm	250 mm
NUCLEODUR® C₁₈ Gravity-SB, 1.8 µm; particle size 1.8 µm · UHPLC							
Analytical EC columns							
	2 mm	760591.20	760593.20	760595.20	760596.20	760598.20	
	3 mm	760591.30	760593.30		760596.30		
	4 mm	760591.40	760593.40		760596.40		
	4.6 mm	760591.46	760593.46		760596.46		
EC guard columns*		4 × 2 mm: 761990.20		4 × 3 mm: 761990.30			
NUCLEODUR® C₁₈ Gravity-SB, 3 µm; particle size 3 µm							
Analytical EC columns							
	2 mm		760603.20		760606.20	760607.20	760608.20
	3 mm		760603.30		760606.30	760607.30	760608.30
	4 mm		760603.40		760606.40	760607.40	760608.40
	4.6 mm		760603.46	760605.46	760606.46	760607.46	760608.46
EC guard columns*		4 × 2 mm: 761991.20		4 × 3 mm: 761991.30			
NUCLEODUR® C₁₈ Gravity-SB, 5 µm; particle size 5 µm							
Analytical EC columns							
	2 mm		760613.20		760616.20	760617.20	760618.20
	3 mm		760613.30		760616.30	760617.30	760618.30
	4 mm		760613.40		760616.40	760617.40	760618.40
	4.6 mm		760613.46	760615.46	760616.46	760617.46	760618.46
EC guard columns*		4 × 2 mm: 761992.20		4 × 3 mm: 761992.30			
Preparative VarioPrep columns							
	10 mm		762350.100			762351.100	762353.100
	21 mm		762350.210			762351.210	762353.210
	32 mm						762353.320
	40 mm						762353.400
VP guard columns**			10 × 8 mm: 762354.80		10 × 16 mm: 762354.160		15 × 32 mm: 762355.320

EC and VarioPrep columns in packs of 1, guard columns see below.

Guard column systems

Guard columns for EC columns with ID		2 mm	3 mm	4 mm	4.6 mm	Guard column holder
* Column Protection System (pack of)	EC	4/2 (3)	4/3 (3)	4/3 (3)	4/3 (3)	718966
Guard columns for VarioPrep columns with ID		8, 10 mm	16, 21 mm	32, 40 mm	≥ 50 mm	
** VP guard columns (pack of)	VP	10/8 (2)	10/16 (2)	15/32 (1)	15/50 (1)	
VP guard column holder		718251	718256	718253	718255	

For details of our column systems see page 258.

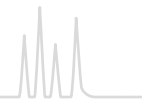

NUCLEODUR[®] C₁₈ Isis phase with high steric selectivity · USP L1

★ Key feature

- Exceptional steric selectivity
- Outstanding surface deactivation
- Suitable for LC/MS and HPLC at pH 1 – 10

🔧 Technical data

- C₁₈ phase with special polymeric, crosslinked surface modification; pore size 110 Å; particle sizes 1.8 μm, 3 μm and 5 μm; carbon content 20 %

✔ Recommended application

- Steroids, (*o,p,m*)-substituted aromatics, fat-soluble vitamins

Surface modification

By use of specific C₁₈ silanes and polymeric bonding technologies a dense shield of alkyl chains protects the subjacent silica matrix. Elemental analysis of NUCLEODUR[®] C₁₈ Isis shows a carbon load of 20 %. The target crosslinking of the C₁₈ chains on the surface enables the separation of compounds with similar molecular structure but different stereochemical properties. The technical term for this feature is steric selectivity.

Slot Model

Sander and Wise [5] proposed a model for the retention of aromatic compounds based on molecular shape, which is referred to as “Slot Model”. This model pictures the bonded C₁₈ phase on the silica surface with slots which the analytes have to penetrate during retention. Planar molecules are able to penetrate these slots deeper than non-planar molecules of similar molecular weight and length-to-width ratio. Thus triphenylene (lower structure) is longer retained than *o*-terphenyl (upper structure).

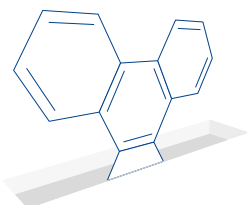
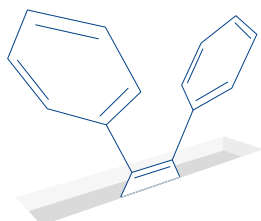

Steric selectivity

The following chromatograms reveal the improved resolution for positional isomers in a test mixture of aromatic compounds on NUCLEODUR[®] C₁₈ Isis (green) in direct comparison with monomerically coated (blue) and polar endcapped (orange) C₁₈ columns.

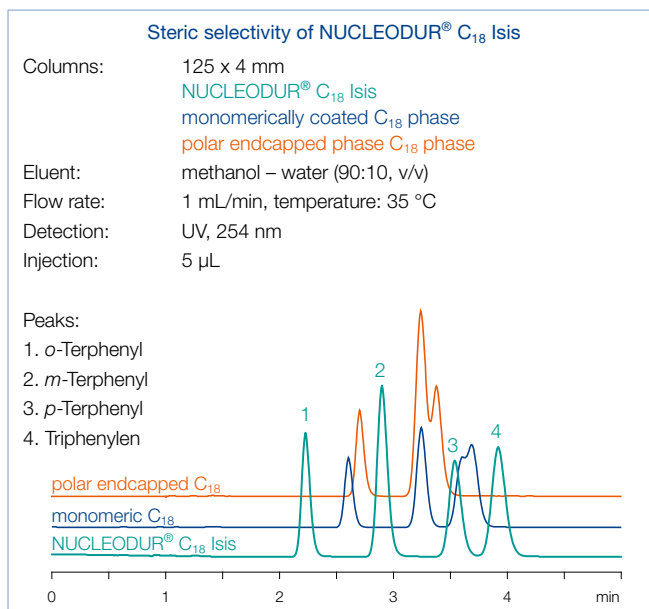

The separation of *o*-terphenyl and triphenylene is a good example to evaluate the selectivity of a RP column in terms of the shape of two molecules. The phenyl rings of *o*-terphenyl are twisted out of plane while triphenylene has a planar geometry. The separation factor α is a measure for the steric selectivity. As is shown below the α value is considerable larger on NUCLEODUR[®] C₁₈ Isis compared to a conventional C₁₈ column.

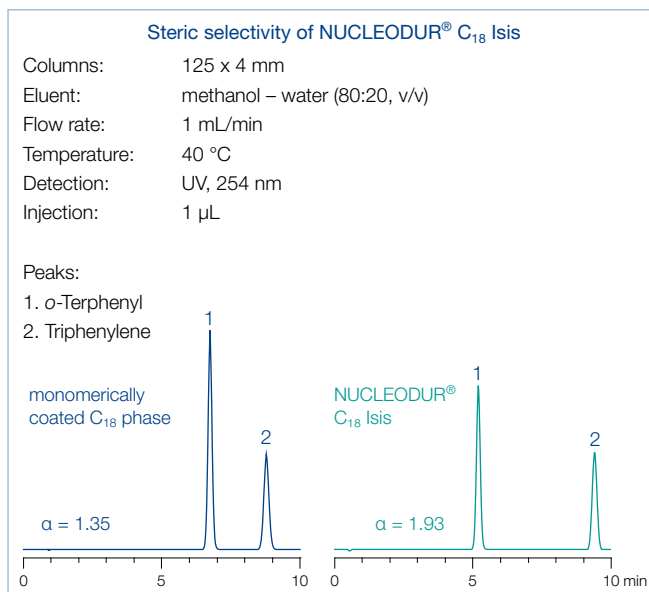







The surface bonding technology also provides improved stability features for the NUCLEODUR® C₁₈ Isis phase.

This ensures tailing-free elution of even strongly basic amino-containing compounds (see application 121210 at <https://chromaappdb.mn-net.com>).

Surface deactivation

The chromatography of basic analytes requires a high density of surface-bonded C₁₈ silanes combined with a thorough endcapping procedure to keep silanol activity at a mini-

Eluent in column acetonitrile – water

ID	Length → 30 mm	50 mm	75 mm	100 mm	125 mm	150 mm	250 mm	
NUCLEODUR® C₁₈ Isis, 1.8 µm; particle size 1.8 µm · UHPLC								
Analytical EC columns								
	2 mm	760406.20	760405.20	760396.20	760407.20		760409.20	
	3 mm	760406.30	760405.30		760407.30			
	4 mm	760406.40	760405.40		760407.40			
	4.6 mm	760406.46	760405.46		760407.46			
EC guard columns*		4 × 2 mm: 761910.20		4 × 3 mm: 761910.30				
NUCLEODUR® C₁₈ Isis, 3 µm; particle size 3 µm								
Analytical EC columns								
	2 mm		760400.20		760401.20	760402.20	760403.20	760404.20
	3 mm		760400.30		760401.30	760402.30	760403.30	760404.30
	4 mm		760400.40		760401.40	760402.40	760403.40	760404.40
	4.6 mm		760400.46	760397.46	760401.46	760402.46	760403.46	760404.46
EC guard columns*		4 × 2 mm: 761911.20		4 × 3 mm: 761911.30				
NUCLEODUR® C₁₈ Isis, 5 µm; particle size 5 µm								
Analytical EC columns								
	2 mm		760410.20		760415.20	760412.20	760413.20	760414.20
	3 mm		760410.30		760415.30	760412.30	760413.30	760414.30
	4 mm		760410.40		760415.40	760412.40	760413.40	760414.40
	4.6 mm		760410.46	760416.46	760415.46	760412.46	760413.46	760414.46
EC guard columns*		4 × 2 mm: 761912.20		4 × 3 mm: 761912.30				
Preparative VarioPrep columns								
	10 mm		762404.100			762405.100		762403.100
	21 mm		762404.210			762405.210		762403.210
	32 mm							762403.320
	40 mm						762406.400	762403.400
VP guard columns **		10 × 8 mm: 762420.80		10 × 16 mm: 762420.160		15 × 32 mm: 762422.320		
EC and VarioPrep columns in packs of 1, guard columns see below.								

Guard column systems

Guard columns for EC columns with ID		2 mm	3 mm	4 mm	4.6 mm	Guard column holder
* Column Protection System (pack of)	EC	4/2 (3)	4/3 (3)	4/3 (3)	4/3 (3)	718966
Guard columns for VarioPrep columns with ID		8, 10 mm	16, 21 mm	32, 40 mm	≥ 50 mm	
** VP guard columns (pack of)	VP	10/8 (2)	10/16 (2)	15/32 (1)	15/50 (1)	
VP guard column holder		718251	718256	718253	718255	

For details of our column systems see page 258.

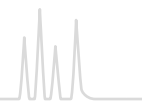

NUCLEODUR[®] C₁₈ Pyramid phase for highly aqueous eluents · USP L1

★ Key feature

- Stable in 100 % aqueous mobile phase systems
- Interesting polar selectivity features
- Excellent base deactivation; suitable for LC/MS due to low bleeding characteristics

🔧 Technical data

- Special phase with polar endcapping; pore size 110 Å; particle sizes 1.8 μm, 3 μm and 5 μm (7 and 10 μm particles for preparative purposes on request); carbon content 14 %; pH stability 1–9

✓ Recommended application

- Analgesics, penicillin antibiotics, nucleic acid bases, water-soluble vitamins, complexing agents, organic acids

RP-HPLC with highly aqueous mobile phases

The efforts to neutralize unwanted silanol activity often results in well base-deactivated RP phases with high carbon load, but a limited scope of selectivity beyond non-polar interactions. Polar compounds like carboxylic acids or drug metabolites show only weak retention on densely bonded RP columns due to distinct hydrophobic properties but low polar interactions. Very polar analytes require highly aqueous mobile phases for solubility and retention. Conventional reversed phase columns often display stability problems in eluent systems with high percentage of water (> 95 %) as evidenced by a sudden decrease of retention time and overall poor reproducibility. This phenomenon is described as phase collapse caused by the mobile phase expelled from the pores due to the fact, that hydrophobic RP phases are incompletely wetted with the mobile phase [6].

Different approaches can be used to increase column stability with highly aqueous mobile phase systems. The most promising concepts are incorporating a polar group in the hydrophobic alkyl chain, or using hydrophilic endcapping procedures to improve the wettability of the reversed phase modification. NUCLEODUR[®] PolarTec may be taken as an example for the embedded polar group strategy, in which a C₁₈ silane with a polar function is successfully linked to the silica surface.

Stability features

NUCLEODUR[®] C₁₈ Pyramid is a silica phase with hydrophilic endcapping, designed especially for use in eluent systems of up to 100 % water. The upper figure shows the retention behavior of tartaric, acetic and maleic acid under purely aqueous conditions on NUCLEODUR[®] C₁₈ Pyramid in comparison with a conventionally bonded C₁₈ phase.

It can be shown that the retention times for NUCLEODUR[®] C₁₈ Pyramid remain nearly unchanged between initial injection and restart after the flow has been stopped for 12 h, whilst the performance of the conventional RP column already collapsed totally after 5 min.

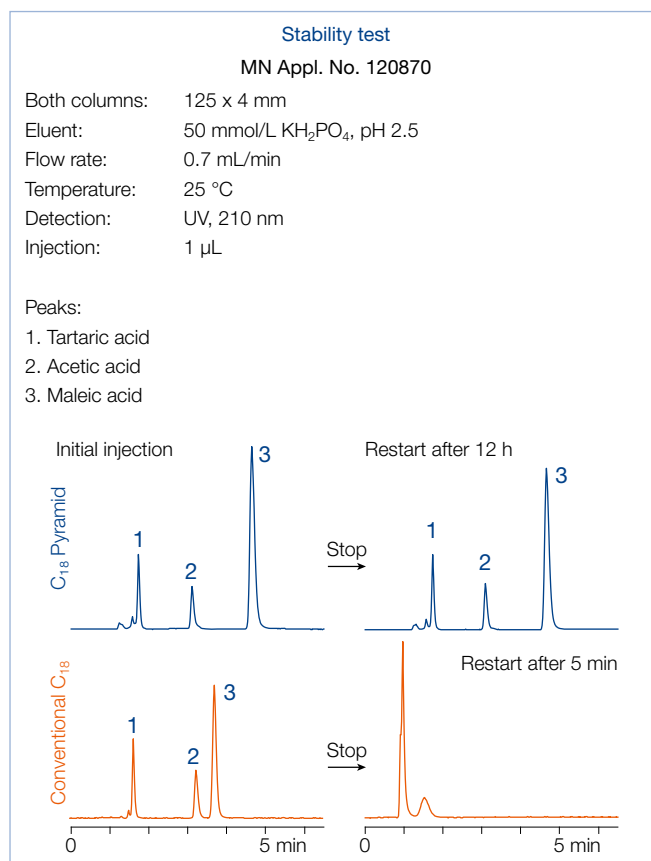

Retention characteristics

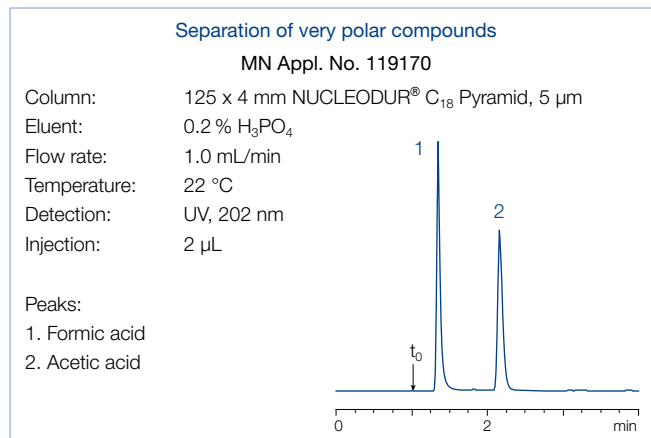







The polar surface exhibits retention characteristics different from conventional C₁₈ phases. Application 119170 shows the improved retention behavior of the very polar short chain organic acids, which are insufficiently retained on RP columns with predominantly hydrophobic surface properties. In addition to the exceptional polar selectivity NUCLEODUR® C₁₈ Pyramid also provides adequate hydrophobic retention (see application

No. 19190 at <https://chromaappdb.mn-net.com>). The perceptible increase in polarity has no impact on the retention behavior of ionizable analytes. Even with the strongly basic compounds of the tricyclic antidepressant drug test mixture, no unwanted interactions or a so-called lack in base deactivation are observed (see application 119200 at <https://chromaappdb.mn-net.com>).

Eluent in column acetonitrile – water

ID	Length → 30 mm	50 mm	75 mm	100 mm	125 mm	150 mm	250 mm
NUCLEODUR® C₁₈ Pyramid, 1.8 µm; particle size 1.8 µm · UHPLC							
Analytical EC columns							
	2 mm	760271.20	760272.20	760275.20	760273.20	760274.20	
	3 mm	760271.30	760272.30		760273.30		
	4 mm	760271.40	760272.40		760273.40		
	4.6 mm	760271.46	760272.46		760273.46		
EC guard columns*		4 × 2 mm: 761915.20		4 × 3 mm: 761915.30			
NUCLEODUR® C₁₈ Pyramid, 3 µm; particle size 3 µm							
Analytical EC columns							
	2 mm		760263.20		760264.20	760260.20	760261.20
	3 mm		760263.30		760264.30	760260.30	760261.30
	4 mm		760263.40		760264.40	760260.40	760261.40
	4.6 mm		760263.46	760259.46	760264.46	760260.46	760261.46
EC guard columns*		4 × 2 mm: 761916.20		4 × 3 mm: 761916.30			
NUCLEODUR® C₁₈ Pyramid, 5 µm; particle size 5 µm							
Analytical EC columns							
	2 mm		760200.20		760204.20	760201.20	760203.20
	3 mm		760200.30		760204.30	760201.30	760203.30
	4 mm		760200.40		760204.40	760201.40	760203.40
	4.6 mm		760200.46	760205.46	760204.46	760201.46	760203.46
EC guard columns*		4 × 2 mm: 761917.20		4 × 3 mm: 761917.30			
Preparative VarioPrep columns							
	10 mm		762271.100			762273.100	762272.100
	21 mm		762271.210			762273.210	762272.210
	32 mm						762272.320
	40 mm					762269.400	762272.400
VP guard columns**		10 × 8 mm: 762291.80		10 × 16 mm: 762291.160		15 × 32 mm: 762293.320	
EC and VarioPrep columns in packs of 1, guard columns see below.							

Guard column systems

Guard columns for EC columns with ID		2 mm	3 mm	4 mm	4.6 mm	Guard column holder
* Column Protection System (pack of)	EC	4/2 (3)	4/3 (3)	4/3 (3)	4/3 (3)	718966
Guard columns for VarioPrep columns with ID		8, 10 mm	16, 21 mm	32, 40 mm	≥ 50 mm	
** VP guard columns (pack of)	VP	10/8 (2)	10/16 (2)	15/32 (1)	15/50 (1)	
VP guard column holder		718251	718256	718253	718255	

For details of our column systems see page 258.

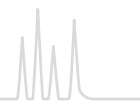

NUCLEODUR[®] PolarTec RP phase with embedded polar group · USP L1 and L60

★ Key feature

- Excellent base deactivation
- Suitable for LC/MS and 100 % aqueous eluents
- Pronounced steric selectivity

🔧 Technical data

- Phase with embedded polar group; pore size 110 Å; particle sizes 1.8 μm, 3 μm and 5 μm; carbon content 17 %; pH stability 1–9

✔ Recommended application

- Exceptional selectivity for phenols and nitrogen containing compounds, polar compounds like basic pharmaceuticals, organic acids, pesticides, amino acids, water-soluble vitamins, etc.

RP-HPLC under 100 % aqueous conditions

The dominant form of interactions of conventional C₁₈ phases are nonpolar London dispersion forces. Besides nonpolar interactions phases with embedded polar groups possess the ability to show polar interactions (dipole-dipole, hydrogen bonds, π-π, etc.). These interactions enhance retention and selectivity for polar compounds like carboxylic acids, phenols and nitrogen containing compounds.

Due to the shielding effect of the embedded group NUCLEODUR[®] PolarTec shows an excellent base deactivation, which is at the top-notch of embedded polar group phases on the market. The pronounced steric selectivity (see Tanaka plot) is an additional tool for the separation of complex mixtures.

Due to low bleeding characteristics NUCLEODUR[®] PolarTec is also suitable for LC/MS.

Even after days or weeks of operation in purely aqueous eluents the C₁₈ chains of NUCLEODUR[®] PolarTec are neither folded nor show any collapsing. A significant reduction of retention time cannot be observed.

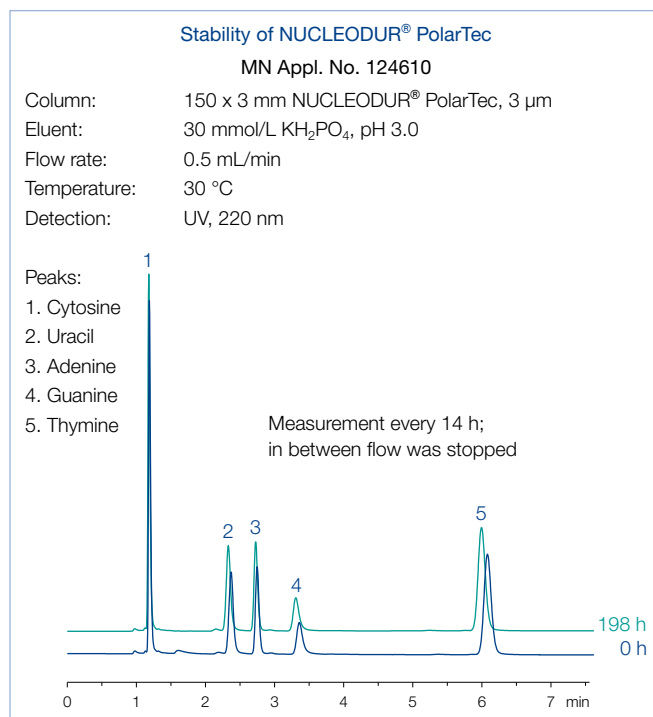
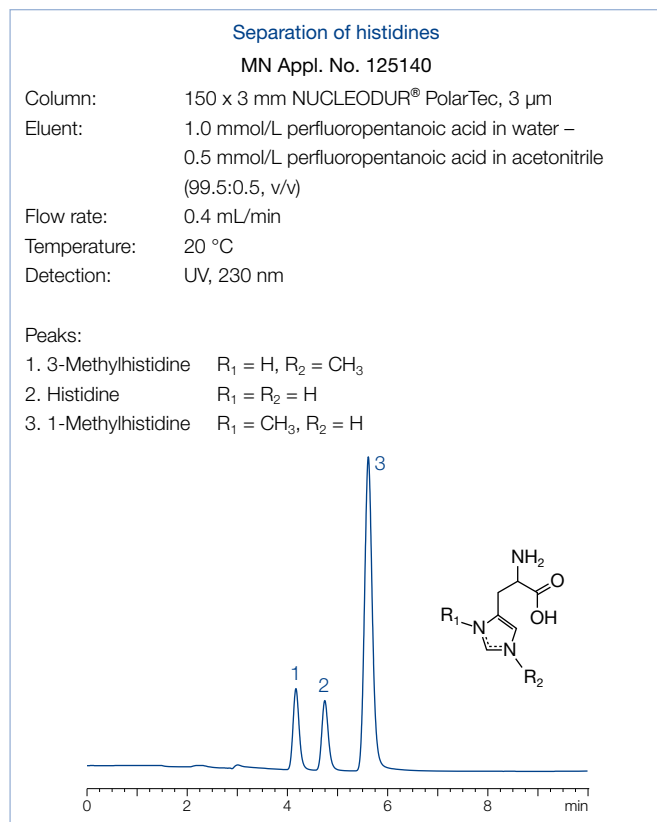

In order to increase retention for polar compounds it is often necessary to decrease the organic ratio of the mobile phase to zero. Under these conditions many conventional C₁₈ phases display the so-called dewetting effect which means that the mobile phase is expelled from the pores. This phenomenon leads to a dramatic loss in retention. NUCLEODUR[®] PolarTec is stable in 100 % aqueous mobile phases and therefore especially suited for the separation of polar compounds like organic acids.

In spite of the polar character of the embedded functional group NUCLEODUR[®] PolarTec exhibits sufficient hydrophobic properties and is very well suited for analyzing basic compounds.



Eluent in column acetonitrile – water

ID	Length → 30 mm	Length						
		50 mm	75 mm	100 mm	125 mm	150 mm	250 mm	
NUCLEODUR® PolarTec, 1.8 µm; particle size 1.8 µm · UHPLC								
Analytical EC columns								
	2 mm	760461.20	760463.20	760465.20	760466.20		760468.20	
	3 mm	760461.30	760463.30		760466.30			
	4 mm	760461.40	760463.40		760466.40			
	4.6 mm	760461.46	760463.46		760466.46			
EC guard columns*		4 × 2 mm: 761980.20		4 × 3 mm: 761980.30				
NUCLEODUR® PolarTec, 3 µm; particle size 3 µm								
Analytical EC columns								
	2 mm		760473.20		760476.20	760477.20	760478.20	760479.20
	3 mm		760473.30		760476.30	760477.30	760478.30	760479.30
	4 mm		760473.40		760476.40	760477.40	760478.40	760479.40
	4.6 mm		760473.46	760475.46	760476.46	760477.46	760478.46	760479.46
EC guard columns*		4 × 2 mm: 761981.20		4 × 3 mm: 761981.30				
NUCLEODUR® PolarTec, 5 µm; particle size 5 µm								
Analytical EC columns								
	2 mm		760483.20		760486.20	760487.20	760488.20	760489.20
	3 mm		760483.30		760486.30	760487.30	760488.30	760489.30
	4 mm		760483.40		760486.40	760487.40	760488.40	760489.40
	4.6 mm		760483.46	760485.46	760486.46	760487.46	760488.46	760489.46
EC guard columns*		4 × 2 mm: 761982.20		4 × 3 mm: 761982.30				
Preparative VarioPrep columns								
	10 mm		762220.100			762221.100		762223.100
	21 mm		762220.210			762221.210		762223.210
	32 mm							762223.320
	40 mm						762222.400	762223.400
VP guard columns**		10 × 8 mm: 762224.80		10 × 16 mm: 762224.160		15 × 32 mm: 762226.320		
EC and VarioPrep columns in packs of 1, guard columns see below.								

Guard column systems

Guard columns for EC columns with ID		2 mm	3 mm	4 mm	4.6 mm	Guard column holder
* Column Protection System (pack of)	EC	4/2 (3)	4/3 (3)	4/3 (3)	4/3 (3)	718966
Guard columns for VarioPrep columns with ID		8, 10 mm	16, 21 mm	32, 40 mm	≥ 50 mm	
** VP guard columns (pack of)	VP	10/8 (2)	10/16 (2)	15/32 (1)	15/50 (1)	
VP guard column holder		718251	718256	718253	718255	

For details of our column systems see page 258.

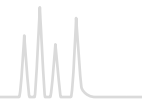

NUCLEODUR[®] Phenyl-Hexyl suitable for polar / aromatic compounds · USP L11

★ Key feature

- Hydrophobic phase with alternative selectivity compared to classical C₁₈ modifications
- Separation principle based on 2 retention mechanisms: π-π interactions and hydrophobic interactions
- Suitable for LC/MS due to low bleeding characteristics

🔧 Technical data

- Phase with phenyl-hexyl modification and multi-endcapping; pore size 110 Å; particle sizes 1.8 μm, 3 μm and 5 μm; carbon content 10 %; pH stability 1 – 10

✓ Recommended application

- Aromatic and unsaturated compounds, polar compounds like pharmaceuticals, antibiotics

Phenylhexyl modified phases are an interesting alternative to classical C₁₈ phases due to an excellent separation of aromatic and unsaturated compounds especially with electron withdrawing groups.

The combination of hydrophobic and polar π-π interactions result in an interesting and alternate selectivity in comparison to C₁₈ and C₈ modified phases.

Through short phenylhexyl chains the NUCLEODUR[®] Phenyl-Hexyl is more polar than the bifunctional modified NUCLEODUR[®] Sphinx RP. Therefore shorter analysis times can be achieved with mixtures of structural similar aromatic and aliphatic unsaturated compounds.

With NUCLEODUR[®] Phenyl-Hexyl e. g., tricyclic antidepressants or water soluble vitamins can be separated in good resolution.

Separation of water-soluble vitamins on NUCLEODUR[®] Phenyl-Hexyl

MN Appl. No. 125920

Column: 100 x 3 mm NUCLEODUR[®] Phenyl-Hexyl, 3 μm
Eluent: A) 0.1 % phosphoric acid in water
B) 0.1 % phosphoric acid in acetonitrile
0 % B for 2 min, then to 60 % B in 7 min
Flow rate: 0.56 mL/min
Temperature: 35 °C
Detection: UV, 215 nm
Injection: 0.8 μL, 1.0 mg/mL each compound 1 mg/mL in eluent

- Peaks:
1. Thiamine
 2. Pyridoxine
 3. *p*-Aminobenzoic acid
 4. Panthothenic acid
 5. Folic acid
 6. Biotin

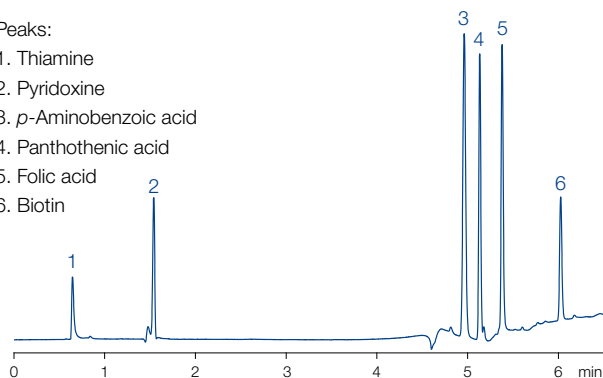

Tricyclic antidepressant (TCA)

MN Appl. No. 126020

Columns: 150 x 3 mm
NUCLEODUR[®] Phenyl-Hexyl, 3 μm
Agilent ZORBAX[®] Eclipse Phenyl-Hexyl, 3.5 μm
Phenomenex Luna[®] Phenyl-Hexyl, 3 μm
Eluent: A) 0.1 % formic acid in acetonitrile
B) 0.1 % formic acid in water
20 – 32.5 % A in 40 min
Flow rate: 0.56 mL/min
Temperature: 40 °C
Detection: UV, 254 nm
Injection: 0.2 μL, each compound 1 mg/mL in eluent

- Peaks:
1. Protriptyline
 2. Nortriptyline
 3. Imipramine
 4. Amitriptyline
 5. Trimipramine

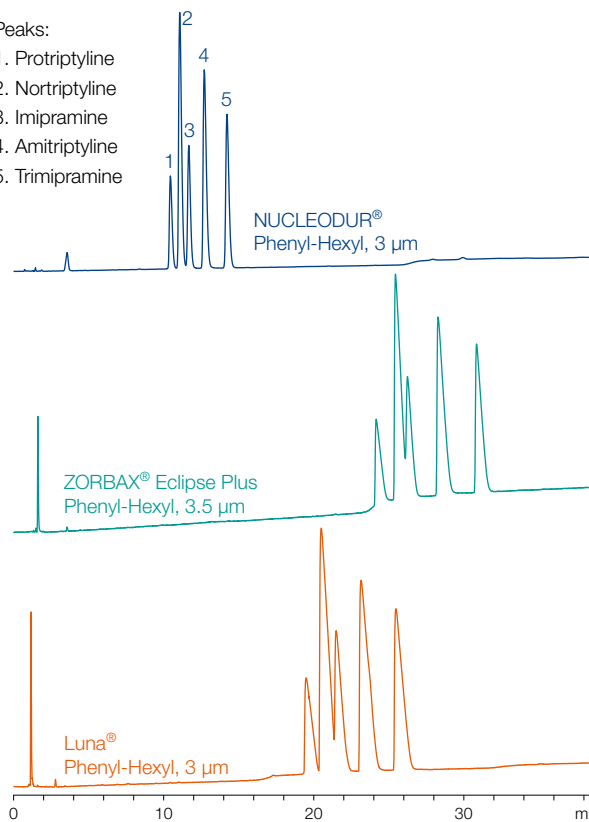



Eluent in column acetonitrile – water

ID	Length → 30 mm	50 mm	75 mm	100 mm	125 mm	150 mm	250 mm	
NUCLEODUR® Phenyl-Hexyl, 1.8 µm; particle size 1.8 µm · UHPLC								
Analytical EC columns								
	2 mm	760561.20	760563.20	760565.20	760566.20		760568.20	
	3 mm	760561.30	760563.30		760566.30			
	4 mm	760561.40	760563.40		760566.40			
	4.6 mm	760561.46	760563.46		760566.46			
EC guard columns*		4 × 2 mm: 761985.20		4 × 3 mm: 761985.30				
NUCLEODUR® Phenyl-Hexyl, 3 µm; particle size 3 µm								
Analytical EC columns								
	2 mm		760573.20		760576.20	760577.20	760578.20	760579.20
	3 mm		760573.30		760576.30	760577.30	760578.30	760579.30
	4 mm		760573.40		760576.40	760577.40	760578.40	760579.40
	4.6 mm		760573.46	760575.46	760576.46	760577.46	760578.46	760579.46
EC guard columns*		4 × 2 mm: 761986.20		4 × 3 mm: 761986.30				
NUCLEODUR® Phenyl-Hexyl, 5 µm; particle size 5 µm								
Analytical EC columns								
	2 mm		760583.20		760586.20	760587.20	760588.20	760589.20
	3 mm		760583.30		760586.30	760587.30	760588.30	760589.30
	4 mm		760583.40		760586.40	760587.40	760588.40	760589.40
	4.6 mm		760583.46	760585.46	760586.46	760587.46	760588.46	760589.46
EC guard columns*		4 × 2 mm: 761987.20		4 × 3 mm: 761987.30				
Preparative VarioPrep columns								
	10 mm		762230.100			762231.100		762233.100
	21 mm							762233.210
	32 mm							762233.320
	40 mm							762233.400
VP guard columns **		10 × 8 mm: 762234.80		10 × 16 mm: 762234.160		15 × 32 mm: 762236.320		
EC and VarioPrep columns in packs of 1, guard columns see below.								

Guard column systems

Guard columns for EC columns with ID		2 mm	3 mm	4 mm	4.6 mm	Guard column holder
* Column Protection System (pack of)	EC	4/2 (3)	4/3 (3)	4/3 (3)	4/3 (3)	718966
Guard columns for VarioPrep columns with ID		8, 10 mm	16, 21 mm	32, 40 mm	≥ 50 mm	
** VP guard columns (pack of)	VP	10/8 (2)	10/16 (2)	15/32 (1)	15/50 (1)	
VP guard column holder		718251	718256	718253	718255	

For details of our column systems see page 258.

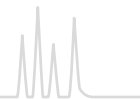

NUCLEODUR[®] π^2 hydrophobic biphenylpropyl phase · USP L11

★ Key feature

- Hydrophobic phase with alternative selectivity compared to classical C₁₈ modifications
- Separation principle based on 2 retention mechanisms (π - π interactions and hydrophobic interactions)
- Better retention of aromatic and unsaturated substances
- Excellent performance under highly aqueous conditions

Stationary HPLC phases with biphenyl ligands like NUCLEODUR[®] π^2 provide an interesting alternative to classical alkyl modified C₁₈ and C₈ HPLC phases due to their remarkable orthogonal selectivity.

Furthermore the NUCLEODUR[®] π^2 provides an excellent separation performance for aromatic and unsaturated analytes by combination of hydrophobic and π - π interactions.

A unique feature is the predominant separation mechanism (π - π or hydrophobic interactions) and thus the selectivity can be controlled by selection of the eluent. In acetonitrile/water

🔧 Technical data

- Phase with biphenylpropyl modification and multi-endcapping; pore size 110 Å; particle size 5 μ m; carbon content 17 %; pH stability 1.5–10

✔ Recommended application

- Overall sophisticated analytical separations, especially aromatic and unsaturated compounds, polar compounds like pharmaceuticals, antibiotics, steroids

NUCLEODUR[®] π^2 shows similar retention strength than C₁₈ modified phases and thereby displays a significantly stronger retention than phenyl phases. These interactions are even further enhanced in a methanol/water eluent.

NUCLEODUR[®] π^2 exceeds other aryl phases in terms of stability under strongly aqueous conditions. Therefore i. a. steroids, sulfonamides and acidic pharmaceuticals are separated in good resolution with NUCLEODUR[®] π^2 . NUCLEODUR[®] π^2 is the stationary phase with the highest aromatic analyte selectivity.

Sulfonamide antibiotics

MN Appl. No. 127920

Columns: 100 × 3 mm each
NUCLEODUR[®] π^2 , 5 μ m
Pinnacle[®] DB Biphenyl, 5 μ m
Ultra Biphenyl, 5 μ m

Eluent: A) 0.1 % TFA in water
B) 0.1 % TFA in methanol
20 % B for 2 min, 20–60 % B in 2 min, 60 % B for 10 min

Flow rate: 0.56 mL/min
Temperature: 30 °C
Detection: UV, 280 nm
Injection: 1 μ L

Peaks:

1. Sulfathiazole
2. Sulfadiazine
3. Sulfachloropyridazine
4. Sulfamerazine
5. Sulfadimidine
6. Sulfamethoxazole
7. Sulfadimethoxine
8. Sulfaquinoxaline

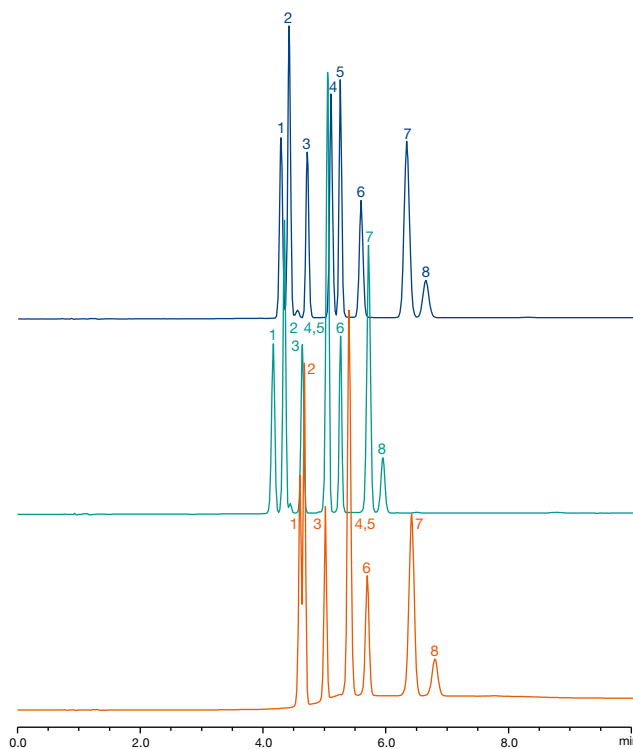



Steroids

MN Appl. No. 127910

Columns: 125 x 4 mm each
 NUCLEODUR® π², 5 μm
 NUCLEODUR® Phenyl-Hexyl, 5 μm
 NUCLEODUR® C₁₈ Gravity, 5 μm

Eluent: acetonitrile – water (45:55, v/v)
 Injection: 1 μL
 Flow rate: 1 mL/min
 Temperature: 25 °C
 Detection: UV, 230 nm

- Peaks:
1. Estriol
 2. Hydrocortisone
 3. Prednisone
 4. β-Estradiol
 5. Corticosterone
 6. Cortisonacetate
 7. Testosterone

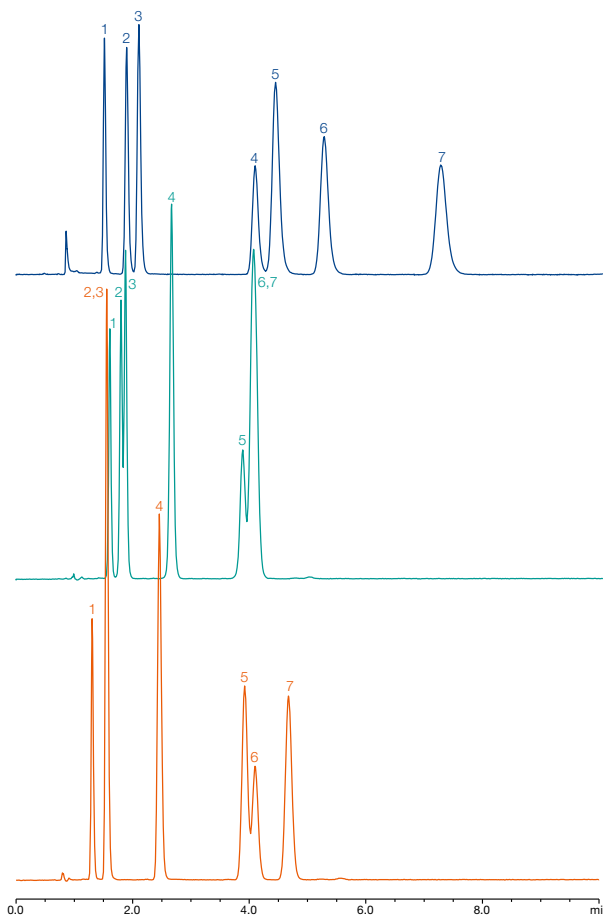

Eluent in column acetonitrile – water

ID	Length →						
	50 mm	75 mm	100 mm	125 mm	150 mm	250 mm	
NUCLEODUR® π ² , 5 μm; particle size 5 μm							
Analytical EC columns							
	2 mm	760620.20	760621.20	760622.20	760623.20	760624.20	760625.20
	3 mm	760620.30	760621.30	760622.30	760623.30	760624.30	760625.30
	4 mm	760620.40	760621.40	760622.40	760623.40	760624.40	760625.40
	4.6 mm	760620.46	760621.46	760622.46	760623.46	760624.46	760625.46
EC guard columns*	4 × 2 mm: 761810.20			4 × 3 mm: 761810.30			
EC columns in packs of 1, guard columns in packs of 3.							

Guard column systems

Guard columns for EC columns with ID	2 mm	3 mm	4 mm	4.6 mm	Guard column holder
* Column Protection System (pack of)	EC 4/2 (3)	4/3 (3)	4/3 (3)	4/3 (3)	718966

For details of our column systems see page 258.

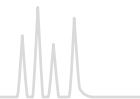

NUCLEODUR[®] PFP hydrophobic pentafluorophenyl phase · USP L43

★ Key feature

- Hydrophobic phase with alternative selectivity in comparison to classical C₁₈ modifications
- Separation principle based on 4 retention mechanisms (polar interactions (H bonds), dipole-dipole, π-π, and hydrophobic interactions)
- Suitable for LC/MS due to low bleeding characteristics

🔧 Technical data

- Phase with pentafluorophenyl-propyl modification and multi-endcapping; pore size 110 Å; particle sizes 1.8 μm, 3 μm and 5 μm; carbon content 8%; pH stability 1–9

✓ Recommended application

- Aromatic and unsaturated compounds, phenols, halogen compounds, isomers, polar compounds like pharmaceuticals, antibiotics; strong retention of basic compounds

Orthogonality in selectivity

Fluorinated stationary phases in HPLC have gained increasing interest over the last years. Most common representative of fluorinated silica phases is the pentafluorophenyl modification (PFP or F₅). Especially the orthogonal selectivity compared to traditional alkyl phases widens the scope in analytical HPLC.

Thus NUCLEODUR[®] PFP offers an excellent selectivity especially for highly polar analytes like aromatic and unsaturated compounds, phenols or halogenated hydrocarbons.

While a typical C₁₈ phase just provides hydrophobic interactions between stationary phase and analyte NUCLEODUR[®] PFP offers four different retention mechanisms: polar interactions (H bonds), dipole-dipole, π-π, and hydrophobic interactions. Especially the pronounced ion exchange capacity and distinct steric selectivity are typical for fluorinated phases.

Due to low bleeding characteristics NUCLEODUR[®] PFP is also suitable for LC/MS. Based on a special surface modification procedure NUCLEODUR[®] PFP offers highest stability also at low pH values.

NUCLEODUR[®] PFP offers a completely different retention behavior compared to alkyl modified silica and is often used for separations which provide insufficient results on traditional C₁₈ phases.

Applications in the areas of (bio-)pharma, natural compounds and environment show the broad applicability of this phase.

Separation of antihistamines

MN Appl. No. 124861

Columns: 250 x 3 mm NUCLEODUR[®] PFP, 5 μm
250 x 3 mm NUCLEODUR[®] C₁₈ Gravity, 5 μm
Eluent: acetonitrile – 20 mmol/L KH₂PO₄ (30:70, v/v)
Flow rate: 1.3 mL/min
Temperature: 30 °C
Detection: UV, 210 nm

Peaks:

1. Maleic acid
2. Chlorpheniramine
3. Brompheniramine
4. Triprolidine
5. Diphenhydramine
6. Promethazine
7. Cetirizine
8. Hydroxyzine

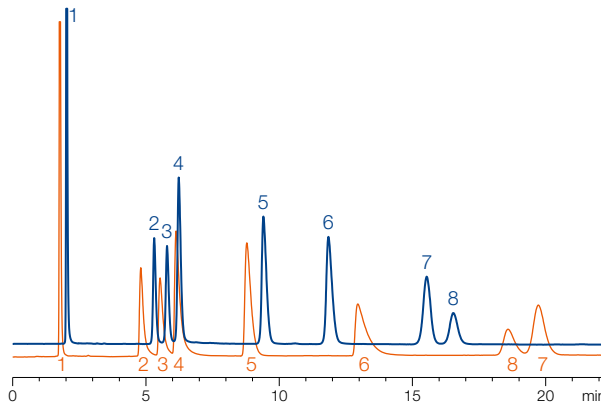



Separation of phenol isomers

MN Appl. No. 124531



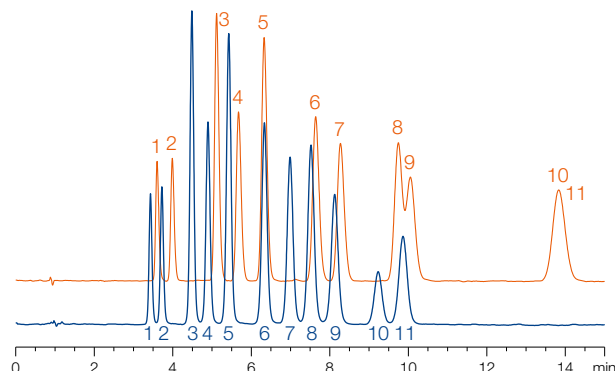

Column: 125 x 4 mm NUCLEODUR® PFP, 5 µm
 125 x 4 mm NUCLEODUR® C₁₈ HTec, 5 µm
 Eluent: acetonitrile, 0.1 % formic acid – water, 0.1 %
 formic acid (35:65, v/v)
 Flow rate: 1 mL/min
 Temperature: 35 °C
 Detection: UV, 280 nm

Peaks:

- | | | |
|-----------------------|-----------------------|-----------------------|
| 1. <i>o</i> -Kresol | 5. 2,5-Dimethylphenol | 9. 3,4-Dichlorophenol |
| 2. <i>m</i> -Kresol | 6. 2,6-Dichlorophenol | 10. 2,4-Dibromophenol |
| 3. 3,4-Dimethylphenol | 7. 2,3-Dichlorophenol | 11. 3,5-Dibromophenol |
| 4. 3,5-Dimethylphenol | 8. 2,4-Dichlorophenol | |



Eluent in column acetonitrile – water

ID	Length → 30 mm	50 mm	75 mm	100 mm	125 mm	150 mm	250 mm
NUCLEODUR® PFP, 1.8 µm; particle size 1.8 µm · UHPLC							
Analytical EC columns							
	2 mm	760431.20	760433.20	760435.20	760436.20	760438.20	
	3 mm	760431.30	760433.30		760436.30		
	4 mm	760431.40	760433.40		760436.40		
	4.6 mm	760431.46	760433.46		760436.46		
EC guard columns*		4 × 2 mm: 761975.20		4 × 3 mm: 761975.30			
NUCLEODUR® PFP, 3 µm; particle size 3 µm							
Analytical EC columns							
	2 mm	760443.20		760446.20	760447.20	760448.20	760449.20
	3 mm	760443.30		760446.30	760447.30	760448.30	760449.30
	4 mm	760443.40		760446.40	760447.40	760448.40	760449.40
	4.6 mm	760443.46	760445.46	760446.46	760447.46	760448.46	760449.46
EC guard columns*		4 × 2 mm: 761976.20		4 × 3 mm: 761976.30			
NUCLEODUR® PFP, 5 µm; particle size 5 µm							
Analytical EC columns							
	2 mm	760453.20		760456.20	760457.20	760458.20	760459.20
	3 mm	760453.30		760456.30	760457.30	760458.30	760459.30
	4 mm	760453.40		760456.40	760457.40	760458.40	760459.40
	4.6 mm	760453.46	760455.46	760456.46	760457.46	760458.46	760459.46
EC guard columns*		4 × 2 mm: 761977.20		4 × 3 mm: 761977.30			
Preparative VarioPrep columns							
	10 mm	762210.100			762211.100		762213.100
	21 mm	762210.210			762211.210		762213.210
	32 mm						762213.320
	40 mm					762212.400	762213.400
VP guard columns **		10 × 8 mm: 762214.80		10 × 16 mm: 762214.160		15 × 32 mm: 762216.320	
EC and VarioPrep columns in packs of 1, guard columns see below.							

Guard column systems

Guard columns for EC columns with ID		2 mm	3 mm	4 mm	4.6 mm	Guard column holder
* Column Protection System (pack of)	EC	4/2 (3)	4/3 (3)	4/3 (3)	4/3 (3)	718966
Guard columns for VarioPrep columns with ID		8, 10 mm	16, 21 mm	32, 40 mm	≥ 50 mm	
** VP guard columns (pack of)	VP	10/8 (2)	10/16 (2)	15/32 (1)	15/50 (1)	
VP guard column holder		718251	718256	718253	718255	

For details of our column systems see page 258.

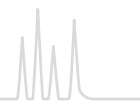

NUCLEODUR® Sphinx RP bifunctional RP phase · USP L1 and L11

★ Key feature

- Distinct selectivity based on well-balanced bifunctional surface coverage
- Widens the scope for method development based on additional π - π interactions
- Suitable for LC/MS due to low bleeding characteristics

🔧 Technical data

- Octadecyl and propylphenyl modified silica; pore size 110 Å; particle sizes 1.8 μ m, 3 μ m and 5 μ m; carbon content 15 %; pH stability 1 – 10; high reproducibility and consistent quality

✔ Recommended application

- Quinolone antibiotics, sulfonamides, xanthenes, substituted aromatics

Alternative RP selectivity

NUCLEODUR® Sphinx RP is characterized by exceptional selectivity features generated by a well-balanced ratio of covalently bonded octadecyl and phenyl groups. The combination of classical hydrophobic with π - π interactions (aromatic ring system) expands the scope of selectivity in comparison with conventional reversed phase packings. NUCLEODUR® Sphinx RP is particularly suited for the separation of molecules containing aromatic and multiple bonds.

For the separation of polar compounds NUCLEODUR® Sphinx RP can be especially recommended and can also outperform many customary C₁₈ phases. In addition, exhaustive endcapping steps minimize unwanted surface silanol activity and guarantee excellent peak shapes even for strong basic analytes.

Stability of NUCLEODUR® Sphinx RP at pH 10

MN Appl. No. 120900

Column: 50 x 4.6 mm NUCLEODUR® Sphinx RP, 5 μ m
Eluent: methanol – dil. NH₃, pH 10 (20:80, v/v)
Flow rate: 1.0 mL/min
Temperature 30 °C
Detection: UV, 275 nm
Injection: 3 μ L

Peaks:
1. Theophylline
2. Caffeine

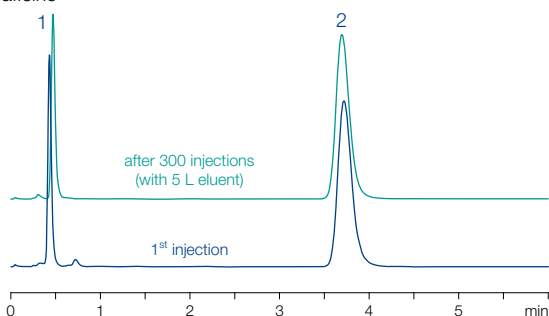

Different from standard phenyl phases, NUCLEODUR® Sphinx RP is far more stable towards hydrolysis and is also suggested for LC/MS applications. Due to the additional intermolecular interactions NUCLEODUR® Sphinx RP is an interesting replenishment to the high density bonded phases NUCLEODUR® C₈/C₁₈ Gravity and the polar endcapped NUCLEODUR® C₁₈ Pyramid.

Separation of flavonoids on three different NUCLEODUR® phases

MN Appl. No. 119830

Columns: 150 x 4.6 mm
NUCLEODUR® Sphinx RP, 5 μ m
NUCLEODUR® C₁₈ Gravity, 5 μ m
NUCLEODUR® C₈ Gravity, 5 μ m
Eluent: water – methanol (40:60, v/v)
Flow rate: 1 mL/min
Temperature: 30 °C
Detection: UV, 270 nm
Injection: 3 μ L

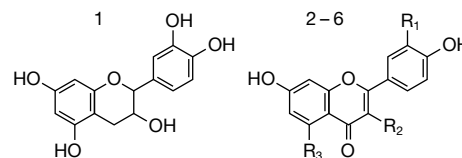



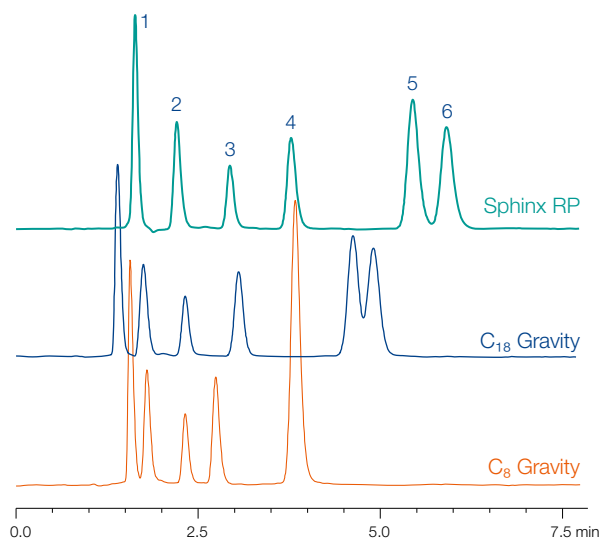

Peaks:
1. Catechin
2. Rutin R₁ = R₃ = OH, R₂ = O-Rutinose
3. Fisetin R₁ = R₂ = OH, R₃ = H
4. Quercetin R₁ = R₂ = R₃ = OH
5. Kaempferol R₁ = H, R₂ = R₃ = OH
6. Isorhamnetin R₁ = OCH₃, R₂ = R₃ = OH





Eluent in column acetonitrile – water

ID	Length → 30 mm	Length						
		50 mm	75 mm	100 mm	125 mm	150 mm	250 mm	
NUCLEODUR® Sphinx RP, 1.8 µm; particle size 1.8 µm · UHPLC								
Analytical EC columns								
	2 mm	760821.20	760822.20	760825.20	760823.20		760824.20	
	3 mm	760821.30	760822.30		760823.30			
	4 mm	760821.40	760822.40		760823.40			
	4.6 mm	760821.46	760822.46		760823.46			
EC guard columns*		4 × 2 mm: 761920.20		4 × 3 mm: 761920.30				
NUCLEODUR® Sphinx RP, 3 µm; particle size 3 µm								
Analytical EC columns								
	2 mm		760806.20		760812.20	760807.20	760805.20	760808.20
	3 mm		760806.30		760812.30	760807.30	760805.30	760808.30
	4 mm		760806.40		760812.40	760807.40	760805.40	760808.40
	4.6 mm		760806.46	760813.46	760812.46	760807.46	760805.46	760808.46
EC guard columns*		4 × 2 mm: 761921.20		4 × 3 mm: 761921.30				
NUCLEODUR® Sphinx RP, 5 µm; particle size 5 µm								
Analytical EC columns								
	2 mm		760800.20		760809.20	760801.20	760802.20	760803.20
	3 mm		760800.30		760809.30	760801.30	760802.30	760803.30
	4 mm		760800.40		760809.40	760801.40	760802.40	760803.40
	4.6 mm		760800.46	760815.46	760809.46	760801.46	760802.46	760803.46
EC guard columns*		4 × 2 mm: 761922.20		4 × 3 mm: 761922.30				
Preparative VarioPrep columns								
	10 mm		762372.100			762375.100		762373.100
	21 mm		762372.210			762375.210		762373.210
	32 mm							762373.320
	40 mm						762371.400	762373.400
VP guard columns**		10 × 8 mm: 762390.80		10 × 16 mm: 762390.160		15 × 32 mm: 762392.320		
EC and VarioPrep columns in packs of 1, guard columns see below.								

Guard column systems

Guard columns for EC columns with ID		2 mm	3 mm	4 mm	4.6 mm	Guard column holder
* Column Protection System (pack of)	EC	4/2 (3)	4/3 (3)	4/3 (3)	4/3 (3)	718966
Guard columns for VarioPrep columns with ID		8, 10 mm	16, 21 mm	32, 40 mm	≥ 50 mm	
** VP guard columns (pack of)	VP	10/8 (2)	10/16 (2)	15/32 (1)	15/50 (1)	
VP guard column holder		718251	718256	718253	718255	

For details of our column systems see page 258.

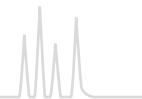

NUCLEODUR[®] C₁₈ HTec base-deactivated preparative octadecyl phase · USP L1

★ Key feature

- Reliable and durable standard RP phase for up-scaling to preparative scale, suited for LC/MS
- High loading capacity and excellent stability
- Outstanding base deactivation

🔧 Technical data

- High density octadecyl modification (C₁₈); pore size 110 Å; particle sizes 1.8 µm, 3 µm, 5 µm, 7 µm and 10 µm for analytical and preparative separations; carbon content 18 %, pH stability 1 – 11

✔ Recommended application

- Sophisticated analytical and preparative separations of basic, neutral and acidic pharmaceuticals, derivatized amino acids, pesticides, fat-soluble vitamins, aldehydes, ketones and phenolic compounds

Preparative separations place high demands on silica based HPLC materials. Apart from excellent selectivity and base deactivation, robustness (pH, pressure stability, ...) and capacity are vital criteria for optimal and efficient separation at the preparative scale.

Selectivity and base deactivation

The innovative endcapping procedure leads to exceptionally good base deactivation – the Engelhardt test demonstrates superb selectivity, peak symmetry and peak shape over the entire polarity range. In addition NUCLEODUR[®] C₁₈ HTec scores in low bleed characteristics and is therefore highly suitable for LC/MS.

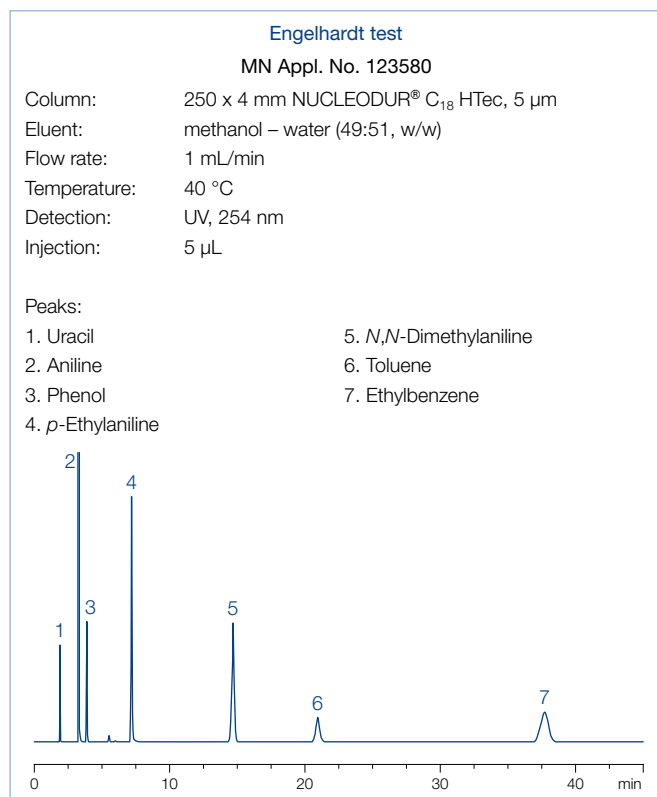

Stability and lifetime

Based on fully synthetic and extremely robust totally spherical NUCLEODUR[®] silica, NUCLEODUR[®] C₁₈ HTec offers outstanding mechanical rigidity and is thus the perfect choice also for self-packing of prep-columns. The special surface modification and endcapping procedure results in high chemical stability even at extreme chromatographic conditions like high flow rates, temperature or critical solvents (DMSO). Furthermore, NUCLEODUR[®] C₁₈ HTec columns show a remarkably long lifetime in acidic (pH 1) as well as basic (pH 10) mobile phases.

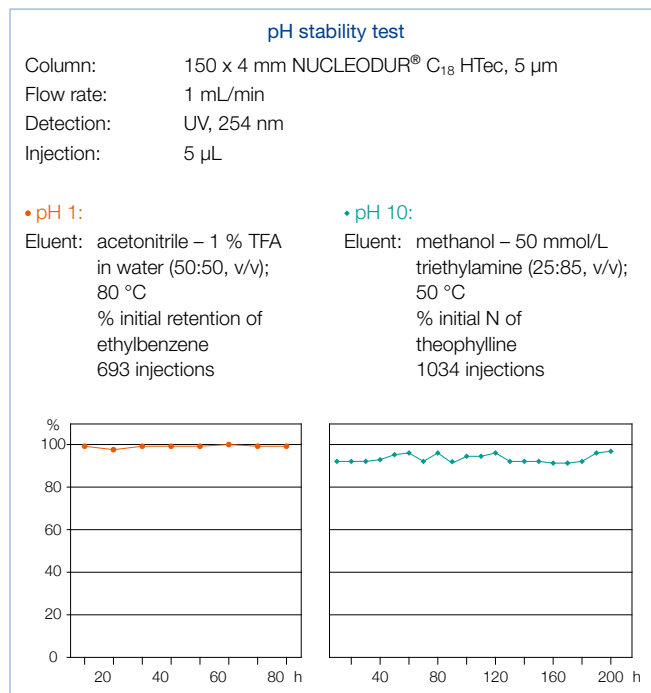

Due to innovative surface coating procedures NUCLEODUR[®] C₁₈ HTec offers excellent analytical separation properties and is the first choice for up-scaling to preparative column dimensions.



Up-scaling

Due to highest quality standards in silica production and phase chemistry combined with optimized packing technology, NUCLEODUR® C₁₈ HTec allows exceptional transferability from analytical to preparative scale with respect to different particle sizes (e. g., 5, 7 or 10 µm) as well as column dimensions (e. g., ID 4.6 to 21 mm).

Capacity

A vital criterion for efficiency in preparative HPLC is the capacity of the separation medium. NUCLEODUR® C₁₈ HTec is characterized by a notably high loading capacity under both basic and acidic conditions, while competitor columns show overload effects even at lower loads (x).

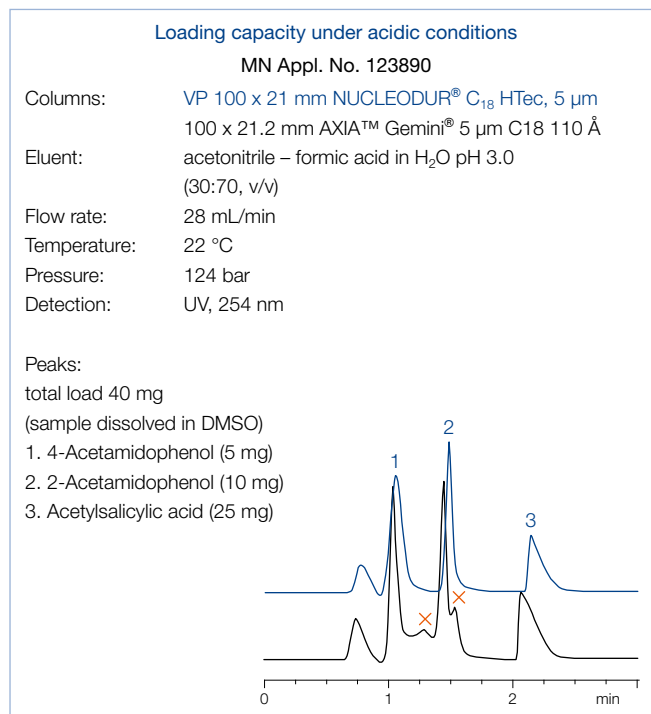
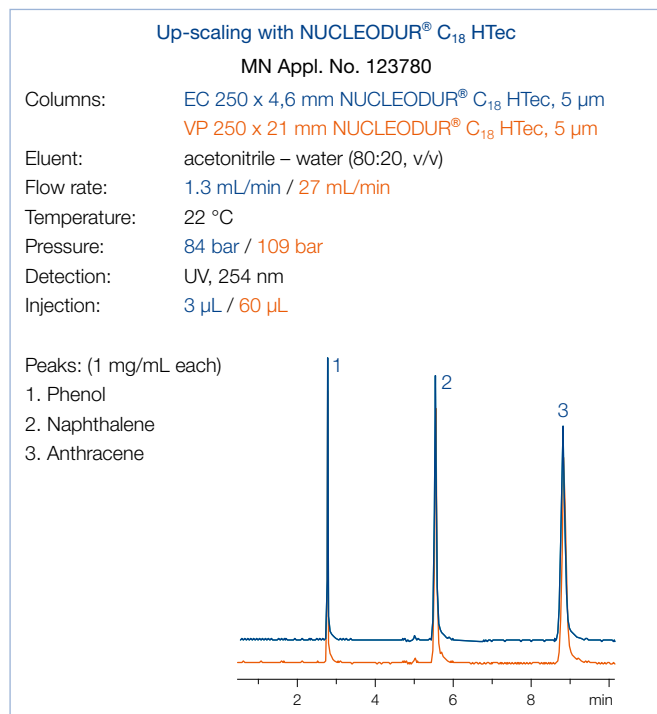

Eluent in column acetonitrile – water

ID	Length →	Length →						
		30 mm	50 mm	75 mm	100 mm	125 mm	150 mm	250 mm
NUCLEODUR® C₁₈ HTec, 1.8 µm; particle size 1.8 µm · UHPLC								
Analytical EC columns								
	2 mm	760301.20	760305.20	760304.20	760306.20		760308.20	
	3 mm	760301.30	760305.30		760306.30			
	4 mm	760301.40	760305.40		760306.40			
	4.6 mm	760301.46	760305.46		760306.46			
EC guard columns*		4 x 2 mm: 761925.20		4 x 3 mm: 761925.30				
NUCLEODUR® C₁₈ HTec, 3 µm; particle size 3 µm								
Analytical EC columns								
	2 mm		760321.20		760323.20	760324.20	760325.20	760326.20
	3 mm		760321.30		760323.30	760324.30	760325.30	760326.30
	4 mm		760321.40		760323.40	760324.40	760325.40	760326.40
	4.6 mm		760321.46	760322.46	760323.46	760324.46	760325.46	760326.46
EC guard columns*		4 x 2 mm: 761926.20		4 x 3 mm: 761926.30				



NUCLEODUR® columns

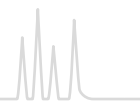

Eluent in column acetonitrile – water

ID	Length → 30 mm	50 mm	75 mm	100 mm	125 mm	150 mm	250 mm
NUCLEODUR® C₁₈ HTec, 5 µm; particle size 5 µm							
Analytical EC columns							
	2 mm	760311.20		760313.20	760314.20	760315.20	760316.20
	3 mm	760311.30		760313.30	760314.30	760315.30	760316.30
	4 mm	760311.40		760313.40	760314.40	760315.40	760316.40
	4.6 mm	760311.46	760312.46	760313.46	760314.46	760315.46	760316.46
EC guard columns*		4 × 2 mm: 761927.20		4 × 3 mm: 761927.30			
Preparative VarioPrep columns							
	10 mm	762551.100			762554.100		762556.100
	21 mm	762551.210		762553.210	762554.210		762556.210
	32 mm			762553.320		762555.320	762556.320
	40 mm					762555.400	762556.400
	50 mm			762553.500		762555.500	762556.500
VP guard columns**		10 × 8 mm: 762591.80		10 × 16 mm: 762591.160			
		15 × 32 mm: 762592.320		15 × 50 mm: 762592.500			
NUCLEODUR® C₁₈ HTec, 7 µm; particle size 7 µm							
Preparative VarioPrep columns							
	10 mm	762561.100			762564.100		762566.100
	21 mm	762561.210		762563.210	762564.210		762566.210
	32 mm			762563.320		762565.320	762566.320
	40 mm					762565.400	762566.400
	50 mm			762563.500		762565.500	762566.500
VP guard columns**		10 × 8 mm: 762591.80		10 × 16 mm: 762591.160			
		15 × 32 mm: 762592.320		15 × 50 mm: 762592.500			
NUCLEODUR® C₁₈ HTec, 10 µm; particle size 10 µm							
Preparative VarioPrep columns							
	10 mm	762571.100			762574.100		762576.100
	21 mm	762571.210		762573.210	762574.210		762576.210
	32 mm			762573.320		762575.320	762576.320
	40 mm					762575.400	762576.400
	50 mm			762573.500		762575.500	762576.500
VP guard columns**		10 × 8 mm: 762591.80		10 × 16 mm: 762591.160			
		15 × 32 mm: 762592.320		15 × 50 mm: 762592.500			

EC and VarioPrep columns in packs of 1, guard columns see below.

Guard column systems

Guard columns for EC columns with ID		2 mm	3 mm	4 mm	4.6 mm	Guard column holder
* Column Protection System (pack of)	EC	4/2 (3)	4/3 (3)	4/3 (3)	4/3 (3)	718966
Guard columns for VarioPrep columns with ID		8, 10 mm	16, 21 mm	32, 40 mm	≥ 50 mm	
** VP guard columns (pack of)	VP	10/8 (2)	10/16 (2)	15/32 (1)	15/50 (1)	
VP guard column holder		718251	718256	718253	718255	

For details of our column systems see page 258.

NUCLEODUR® C₁₈ HTec bulk material in 7 and 10 µm for self-packing of preparative columns see page 264.



NUCLEODUR[®] C₁₈ ec · C₈ ec · C₄ ec nonpolar phases for routine analysis · USP L1 (C₁₈) · L7 (C₈) · L26 (C₄)

★ Key feature

- Ideal and reliable standard RP phase for daily routine analysis and up-scaling for preparative HPLC
- Medium density Octadecyl (C₁₈) and octyl (C₈) with pore size of 110 Å with exhaustive endcapping for a wide range of applications
- Octadecyl (C₁₈) and butyl (C₄) with pore size of 300 Å for the separation of biomolecules

🔧 Technical data

- Pore size 110 Å: particle sizes 3 μm and 5 μm, 7 μm, 10 μm, 12 μm, 16 μm, 20 μm, 30 μm and 50 μm for preparative separations; carbon content 17.5 % for C₁₈, 10.5 % for C₈; pH stability 1–9; high reproducibility from lot to lot
- Pore size 300 Å: technical data and applications in chapter “HPLC column for biochemical separations” (see page 244)

✓ Recommended application

- 110 Å: basic, neutral or acidic drugs; derivatized amino acids; pesticides; fat-soluble vitamins; aldehydes and ketones; phenolic compounds
- 300 Å: biomolecular macromolecules, like proteins and peptides

NUCLEODUR[®] C₁₈ ec for daily routine analysis

The efficiency of a separation is controlled by particle size and selectivity of the stationary phase. The exceptional surface coverage of monomeric bonded alkylsilanes, combined with an exhaustive endcapping, results in a surface with lowest silanol activity. This allows the tailing-free elution of polar compounds such as basic drugs. NUCLEODUR[®] C₁₈ ec is available in 9 different particle sizes (3, 5, 7, 10, 12, 16, 20, 30 and 50 μm) which cover the whole range from high speed analytical HPLC up to medium and low pressure prep LC. NUCLEODUR[®] C₁₈ ec is also an ideal tool for scale-up purposes.

Loading capacity

Loading capacity, probably the most important feature for preparative LC applications, is determined by pore size, pore volume and surface area of the packing. However, it can also be influenced by the molecular weight of the analytes. In the figure below the mass loading curve for acetophenone and butyrophenone on a NUCLEODUR[®] 100-20 C₁₈ ec column describes the correlation between the increase of column loading and the decrease of separation efficiency.

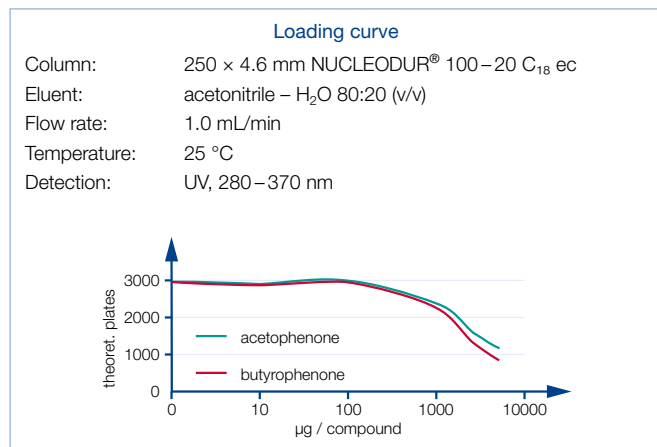

pH stability of NUCLEODUR[®] C₁₈ ec

Separation of theophylline and caffeine at pH 10

Column: 30 × 3 mm NUCLEODUR[®] 100-5 C₁₈ ec
Eluent: methanol – aq. NH₃ (20:80, v/v), pH 10
Flow rate: 0.5 mL/min
Temperature: 25 °C
Detection: UV, 254 nm

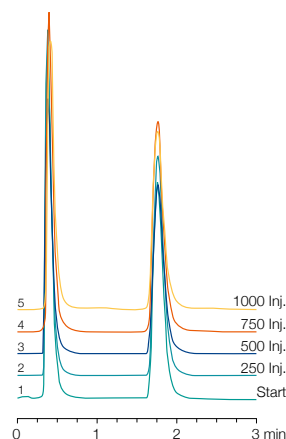

Separation of uracil, veratrol, toluene and ethylbenzene at pH 1.5

Column: 30 × 3 mm NUCLEODUR[®] 100-5 C₁₈ ec
Eluent: acetonitrile – H₂O (65:35, v/v), TFA, pH 1.5
Flow rate: 1.0 mL/min
Temperature: 25 °C
Detection: UV, 254 nm

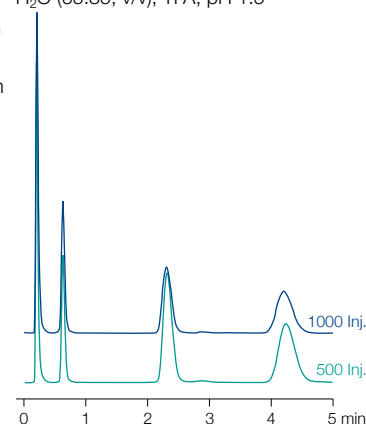

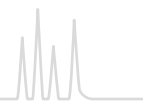

Chemical stability

The utmost purity of the base silica and the exceptional silane bonding chemistry minimize the risk of dissolution, or hydrolysis at pH extremes.

The chromatograms show the retention behavior at pH values of 1.5 and 10.0 for NUCLEODUR[®] 100-5 C₁₈ ec.

NUCLEODUR[®] octyl phases

In addition to NUCLEODUR[®] C₁₈ phases MACHEREY-NAGEL offers octyl modified NUCLEODUR[®] C₈ Gravity and NUCLEODUR[®] C₈ ec columns to expand the RP tool box. Based on the same spherical high purity silica the C₈ phases exhibit the same chemical and mechanical stability as the C₁₈ counterparts. Indeed NUCLEODUR[®] C₈ Gravity can also be run at pH extremes (pH 1 – 11) by choosing appropriate elution parameters. Due to the shorter chain and less hydrophobic properties of the stationary phase the retention of non-polar compounds is decreased, and in consequence a reduction in time of analysis can be achieved. Moreover a stronger polar selectivity, particularly with the separation of ionizable analytes is frequently observed (as distinct from the C₁₈ phases). NUCLEODUR[®] C₈ ec and NUCLEODUR[®] C₈ Gravity are most suitable for the development of new methods but also for robust routine analyses.

There are no general guidelines which could make the choice between C₈ and C₁₈ phases easier but it will always be beneficial to add both phases to the existing pool of RP columns in the laboratory. Comparative studies reveal some different selectivity patterns of NUCLEODUR[®] C₈ ec and C₁₈ ec. The separation of phenols at right shows baseline separation for 2-ethoxyphenol and dimethoxybenzene (veratrol) and in addition a reversal of the elution order of phenol and 4-methoxyphenol can be shown on the octyl phase.

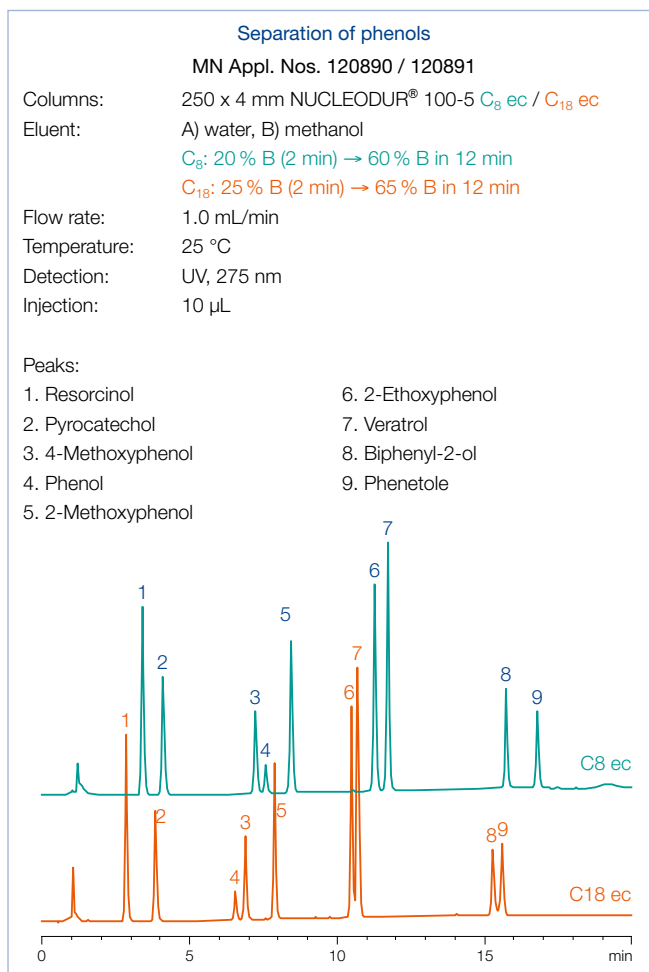

NUCLEODUR[®] phases for biochromatography

A description and applications for C₁₈ and C₄ modified 300 Å NUCLEODUR[®] widepore materials for the separation of biopolymers, like peptids and proteins can be found in chapter “HPLC column for biochemical separations” (see page 244).

C₁₈ or C₈ · the best of both worlds



- Octyl phases (C₈) show superior polar selectivity.
- Octadecyl phases (C₁₈) show superior hydrophobic selectivity.
- Hydrophobic compounds show shorter retention times on C₈ phases.

Eluent in column acetonitrile – water



ID	Length →						
	50 mm	75 mm	100 mm	125 mm	150 mm	250 mm	
NUCLEODUR [®] 100-3 C ₁₈ ec; octadecyl phase, particle size 3 µm, 17.5 % C							
Analytical EC columns							
	2 mm	760050.20		760054.20	760051.20	760053.20	760052.20
	3 mm	760050.30		760054.30	760051.30	760053.30	760052.30
	4 mm	760050.40		760054.40	760051.40	760053.40	760052.40
	4.6 mm	760050.46	760046.46	760054.46	760051.46	760053.46	760052.46
EC guard columns*							
			4 × 2 mm: 761931.20		4 × 3 mm: 761931.30		



Eluent in column acetonitrile – water

ID	Length → 50 mm	75 mm	100 mm	125 mm	150 mm	250 mm	
NUCLEODUR® 100-5 C₁₈ ec; octadecyl phase, particle size 5 µm, 17.5 % C							
Analytical EC columns							
	2 mm	760004.20		760013.20	760001.20	760008.20	760002.20
	3 mm	760004.30		760013.30	760001.30	760008.30	760002.30
	4 mm	760004.40		760013.40	760001.40	760008.40	760002.40
	4.6 mm	760004.46	760035.46	760013.46	760001.46	760008.46	760002.46
EC guard columns*		4 × 2 mm: 761932.20		4 × 3 mm: 761932.30			
Preparative VarioPrep columns							
	10 mm	762003.100			762029.100		762022.100
	21 mm	762003.210			762029.210		762022.210
	32 mm						762022.320
	40 mm					762027.400	762022.400
VP guard columns**		10 × 8 mm: 762090.80		10 × 16 mm: 762090.160			
		15 × 32 mm: 762311.320		15 × 50 mm: 762311.500			
NUCLEODUR® 100-10 C₁₈ ec; octadecyl phase, particle size 10 µm, 17.5 % C							
Preparative VarioPrep columns							
	10 mm	762011.100			762302.100		762010.100
	21 mm	762011.210			762302.210		762010.210
	32 mm						762010.320
	40 mm					762303.400	762010.400
	50 mm						762010.500
VP guard columns**		10 × 8 mm: 762090.80		10 × 16 mm: 762090.160			
		15 × 32 mm: 762311.320		15 × 50 mm: 762311.500			

Eluent in column acetonitrile – water

ID	Length → 50 mm	75 mm	100 mm	125 mm	150 mm	250 mm	
NUCLEODUR® 100-3 C₈ ec; octyl phase, particle size 3 µm, 10.5 % C							
Analytical EC columns							
	2 mm	760063.20		760059.20	760060.20	760062.20	
	3 mm	760063.30		760059.30	760060.30	760062.30	
	4 mm	760063.40		760059.40	760060.40	760062.40	
	4.6 mm	760063.46	760064.46	760059.46	760060.46	760061.46	760062.46
EC guard columns*		4 × 2 mm: 761936.20		4 × 3 mm: 761936.30			
NUCLEODUR® 100-5 C₈ ec; octyl phase, particle size 5 µm, 10.5 % C							
Analytical EC columns							
	2 mm	760700.20		760704.20	760701.20	760703.20	
	3 mm	760700.30		760704.30	760701.30	760703.30	
	4 mm	760700.40		760704.40	760701.40	760703.40	
	4.6 mm	760700.46	760706.46	760704.46	760701.46	760702.46	760703.46
EC guard columns*		4 × 2 mm: 761937.20		4 × 3 mm: 761937.30			
Preparative VarioPrep columns							
	10 mm	762072.100			762061.100	762062.100	
	21 mm	762072.210			762061.210	762062.210	
	32 mm					762062.320	
	40 mm					762079.400	762062.400
VP guard columns**		10 × 8 mm: 762092.80		10 × 16 mm: 762092.160		15 × 32 mm: 762321.320	
EC and VarioPrep columns in packs of 1, guard columns see previous NUCLEODUR® phases.							

Guard column systems see previous NUCLEODUR® phases. For details of our column systems see page 258.

NUCLEODUR® C₁₈ ec bulk material with 10 – 50 µm for self-packing of preparative columns see page 264.

The ordering information for C₁₈ and C₄ modified 300 Å NUCLEODUR® widepore materials for the separation of biopolymers can be found in the chapter “HPLC column for biochemical separations” (see page 248).

* and ** for corresponding guard column systems see page 258.

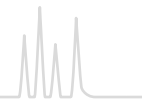

NUCLEODUR® HILIC zwitterionic phase

★ Key feature

- Ideal for reproducible and stable chromatography of highly polar analytes
- Suitable for analytical and preparative applications
- Very short column conditioning period

🔧 Technical data

- Ammonium – sulfonic acid modified silica; pore size 110 Å; particle sizes 1.8, 3 and 5 µm; carbon content 7 %; pH stability 2 – 8.5

✓ Recommended application

- Hydrophilic compounds such as organic polar acids and bases, polar natural compounds, nucleosides, oligonucleotides, amino acids, peptides, water soluble vitamins

Hydrophilic interaction chromatography

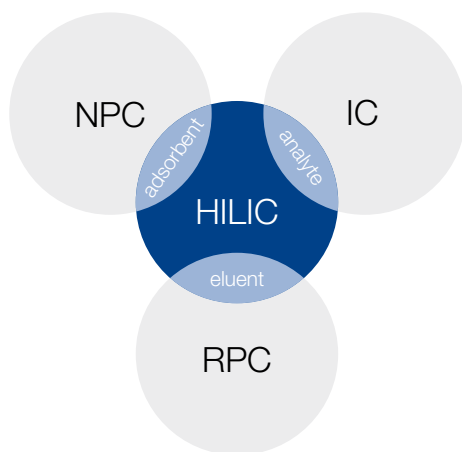

Especially for polar compounds reversed phase HPLC – the most common analytical method – is often limited. Here, hydrophilic stationary phases provide an additional tool for the separation of polar analytes in HPLC.

The expression HILIC (Hydrophilic Interaction Chromatography) was firstly published by Andrew Alpert in 1990 – since then it took quite some efforts to develop robust and reproducible hydrophilic HPLC phases for HILIC chromatography [7].

HILIC combines the characteristics of the 3 major methods in liquid chromatography – reversed phase (RPC), normal phase (NPC) and ion chromatography (IC):

- Stationary phases (adsorbents) are mostly polar modifications of silica or polymers (SiOH, NH₂, Diol, (zwitter) ions, ...) – like in NPC.
- Mobile phases (eluent) are mixtures of aqueous buffer systems and organic modifier like acetonitrile or methanol – like in RPC.
- Fields of application include quite polar compounds as well as organic and inorganic ions – like in IC.

Summarized: “HILIC is NP chromatography of polar and ionic compounds under RP conditions.”

NUCLEODUR® HILIC is a special zwitterionic modified stationary phase based on ultra spherical NUCLEODUR® particles. The betaine character of the ammoniumsulfonic acid ligands results in total charge equalization and in an overall neutrally charged but highly polar surface.

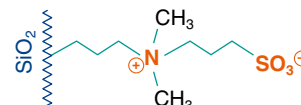

Retention characteristic

Commonly HILIC is described as partition chromatography or liquid-liquid extraction system between mobile and stationary phases. Versus a water-poor mobile phase a water-rich layer on the surface of the polar stationary phase is formed. Thus, a distribution of the analytes between these two layers will occur. Furthermore HILIC includes weak electrostatic mechanisms as well as hydrogen donor interactions between neutral polar molecules under high organic elution conditions. This distinguishes HILIC from ion exchange chromatography – main principle for HILIC separation is based on compound's polarity and degree of solvation.

Separation of uracil and naphthalene

MN Appl. Nos. 122911 / 122912

Columns: A) 125 x 4 mm NUCLEODUR® C₁₈ Pyramid, 3 µm
B) 125 x 4 mm NUCLEODUR® HILIC, 3 µm
Eluent: acetonitrile – water (90:10, v/v)
Flow rate: 1.0 mL/min
Temperature: 25 °C
Detection: UV, 254 nm

Peaks:
1. Uracil
2. Naphthalene

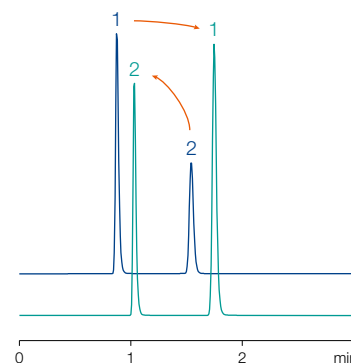

More polar compounds will have stronger interaction with the stationary aqueous layer than less polar compounds – resulting in a stronger retention. Nonpolar compounds exhibit faster elution profiles due to minor hydrophobic interactions. In the separation of uracil and naphthalene the elution order is quite often inverse on HILIC columns compared to RP columns.



Stability features

Due to an advanced and unique surface modification procedure (pat. pend.) NUCLEODUR[®] HILIC columns provide short equilibration times – after just 20 min equilibration already the 2nd injection shows stable and reproducible results.

Beyond this, NUCLEODUR[®] HILIC columns are characterized by an outstanding column life time – even after nearly 800 runs the columns show no loss of pristine performance - peak shape and retention are still immaculate. Due to its high loading capacity NUCLEODUR[®] HILIC is absolutely suitable for preparative and semi-preparative applications.

Overall NUCLEODUR[®] HILIC provides excellent chromatographic features and is hereby the perfect choice for separation of polar or charged compounds.

Stability and equilibration

MN Appl. No. 123100



Column: 250 x 4 mm NUCLEODUR[®] HILIC, 5 µm
 Eluent: CH₃CN – 5 mmol/L ammonium acetate (80:20, v/v)
 Flow rate: 0.6 mL/min
 Temperature: 25 °C
 Detection: UV, 254 nm

Peaks:

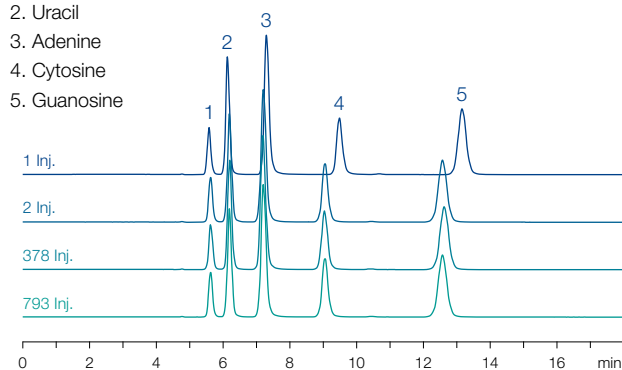
1. Thymine
2. Uracil
3. Adenine
4. Cytosine
5. Guanosine



Eluent in column acetonitrile – water (80:20, v/v)

ID	Length →						
	30 mm	50 mm	75 mm	100 mm	125 mm	150 mm	250 mm
NUCLEODUR[®] HILIC, 1.8 µm; particle size 1.8 µm · UHPLC							
Analytical EC columns							
	2 mm	760521.20	760523.20	760525.20	760526.20	760528.20	
	3 mm	760523.30		760526.30			
	4 mm				760526.40		
	4.6 mm				760526.46		
EC guard columns*		4 × 2 mm: 761960.20			4 × 3 mm: 761960.30		
NUCLEODUR[®] HILIC, 3 µm; particle size 3 µm							
Analytical EC columns							
	2 mm	760532.20		760534.20	760531.20	760533.20	760530.20
	3 mm	760532.30		760534.30	760531.30	760533.30	760530.30
	4 mm	760532.40		760534.40	760531.40	760533.40	760530.40
	4.6 mm	760532.46		760534.46	760531.46	760533.46	760530.46
EC guard columns*		4 × 2 mm: 761961.20			4 × 3 mm: 761961.30		
NUCLEODUR[®] HILIC, 5 µm; particle size 5 µm							
Analytical EC columns							
	2 mm	760552.20		760554.20	760551.20	760553.20	760550.20
	3 mm	760552.30		760554.30	760551.30	760553.30	760550.30
	4 mm	760552.40		760554.40	760551.40	760553.40	760550.40
	4.6 mm	760552.46		760554.46	760551.46	760553.46	760550.46
EC guard columns*		4 × 2 mm: 761962.20			4 × 3 mm: 761962.30		

Guard column system

Guard columns for EC columns with ID	2 mm	3 mm	4 mm	4.6 mm	Guard column holder
* Column Protection System (pack of)	EC 4/2 (3)	4/3 (3)	4/3 (3)	4/3 (3)	718966

For details of our column systems see page 258.

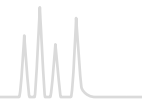

NUCLEODUR[®] CN / CN-RP cyano-modified high purity silica phase · USP L10

★ Key feature

- High retention capacity especially for very polar and unsaturated compounds
- Multi-mode column (RP and NP) widens scope of selectivity
- Stable against hydrolysis at low pH (working range pH 1–8)

🔧 Technical data

- Cyanopropyl-modified high purity silica; pore size 110 Å; particle sizes 3 µm and 5 µm; carbon content 7 %; special endcapping
- High reproducibility from lot to lot; different retention characteristics in comparison to C₈ and C₁₈

✓ Recommended application

- Tricyclic antidepressants, steroids, organic acids

Alternative bonded-phase functionality

In reversed phase HPLC it is fairly common to start with C₁₈ or C₈ columns, if new methods have to be developed. However, superior polarity and selectivity properties often required for more sophisticated separations, are not always sufficiently provided by classical RP phases, which are usually characterized by a hydrophobic layer of monomeric or polymeric bonded alkylsilanes.

One approach to improve the resolution of compounds poorly separated on nonpolar stationary phases, is to change bonded-phase functionality.

The fully endcapped and highly reproducible NUCLEODUR[®] 100-5 CN-RP phase has cyanopropyl groups on the surface able to generate a clearly recognizable different retention behavior compared to purely alkyl-functionalized surface modifications (see figure below).

The polarity of NUCLEODUR[®] 100-5 CN-RP can be classified as intermediate based on multiple retention mechanisms such as dipole-dipole, π-π, and also hydrophobic interactions [8]. Therefore, this phase shows a distinct selectivity for polar organic compounds as well as for molecules containing π electron systems (e. g., analytes with double bonds, tricyclic antidepressants) [9].

Short-chain bonded phases are sometimes suspected of revealing shortcomings in stability towards hydrolysis at low pH [10]. Application 119350 shows that even after 100 sample injections and four weeks storage at pH 1 (blue curve), neither a considerable shift in retention, nor a visible change in peak symmetry could be noticed (green curve = new column).

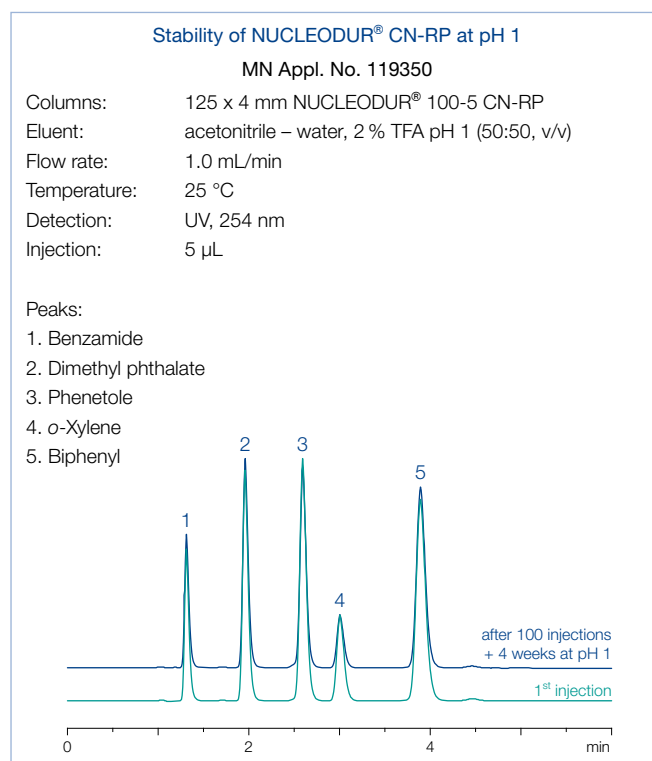
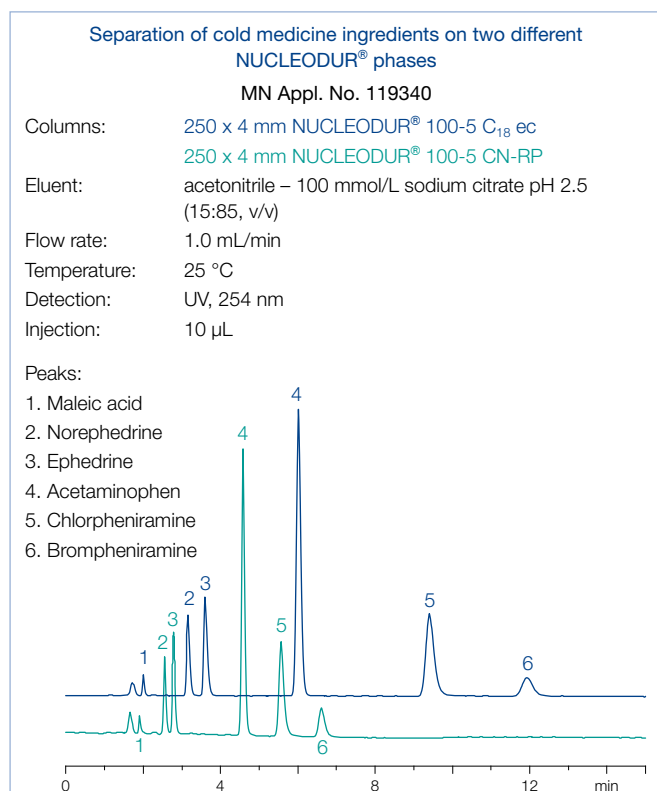



Multi-mode columns

Due to its polarity the cyano phase can also be run in normal phase mode. NUCLEODUR® CN columns for NP applications are shipped in *n*-heptane. The change in selectivity and order of elution for a mixture of various steroids in NP and RP mode is

displayed below. The high coverage combined with a thorough endcapping makes NUCLEODUR® 100-5 CN-RP suitable for separation of ionizable compounds such as basic drugs.

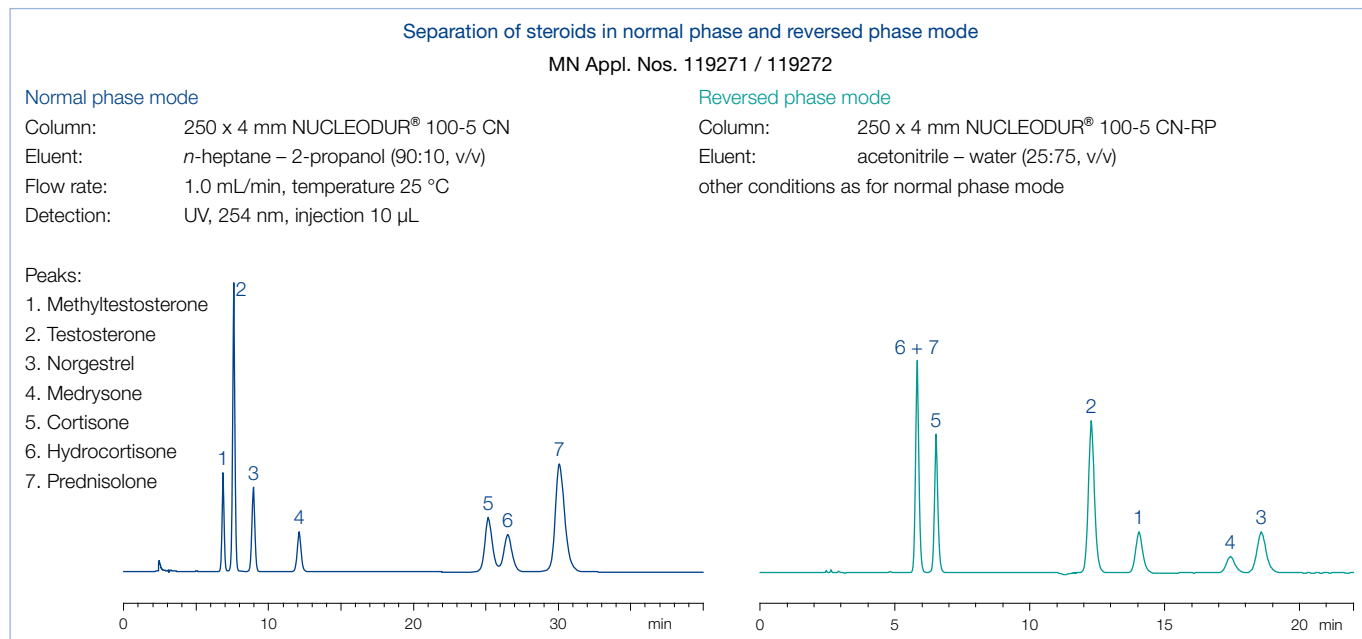

ID	Length →			
	50 mm	125 mm	150 mm	250 mm
NUCLEODUR® 100-3 CN-RP; particle size 3 µm; eluent in column acetonitrile – water				
Analytical EC columns				
	2 mm	760159.20	760157.20	
	3 mm		760157.30	
	4 mm			760156.40
	4.6 mm			760156.46
EC guard columns*		4 × 2 mm: 761941.20	4 × 3 mm: 761941.30	
NUCLEODUR® 100-5 CN-RP; particle size 5 µm; eluent in column acetonitrile – water				
Analytical EC columns				
	4 mm		760153.40	760152.40
	4.6 mm		760153.46	760152.46
EC guard columns*			4 × 3 mm: 761944.30	
NUCLEODUR® 100-5 CN; particle size 5 µm; eluent in column <i>n</i> -heptane				
Analytical EC columns				
	4 mm		760151.40	760149.40
	4.6 mm		760151.46	760149.46
EC guard columns*			4 × 3 mm: 761943.30	
EC columns in packs of 1, guard columns in packs of 3.				

Guard column system

Guard columns for EC columns with ID	2 mm	3 mm	4 mm	4.6 mm	Guard column holder
* Column Protection System (pack of)	EC 4/2 (3)	4/3 (3)	4/3 (3)	4/3 (3)	718966

For details of our column systems see page 258.

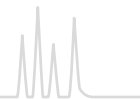

NUCLEODUR[®] NH₂/NH₂-RP amino-modified high purity silica · USP L8

★ Key feature

- Multi-mode columns (for RP, NP and IC)
- Stable against hydrolysis at low pH (working range pH 2–8), 100 % stable in water; suitable for LC/MS
- Widens scope of analytical HPLC into the polar range

🔧 Technical data

- Aminopropyl modified high purity silica; pore size 110 Å; particle sizes 3, 5 and 7 µm; carbon content 2.5 %; not endcapped

✓ Recommended application

- Polar compounds under RP conditions (sugars, DNA bases), hydrocarbons under NP conditions

- Normal phase chromatography (NP) with hexane, dichloromethane or 2-propanol as mobile phase for polar compounds such as substituted anilines, esters, chlorinated pesticides
- Reversed phase chromatography (RP) of polar compounds in aqueous-organic eluent systems
- Ion exchange chromatography of anions and organic acids using conventional buffers and organic modifiers

Some compounds, especially polar substances, cannot be sufficiently resolved on C₁₈ phases. Polar-modified silica phases offer alternative selectivities thus expanding the spectrum of analytical HPLC into the polar range.

Main field of application of NUCLEODUR[®] NH₂ is the separation of simple and complex sugars, sugar alcohols and other hydroxy compounds under RP conditions as well as hydrocarbons under NP conditions.

Multi-mode columns

Besides cyano modifications, amino modifications belong to the most frequently used polar silica phases – both feature the important advantage, that they can be run in the RP mode using aqueous-organic eluent mixtures as well as in the NP mode, e. g., with hexane as mobile phase.

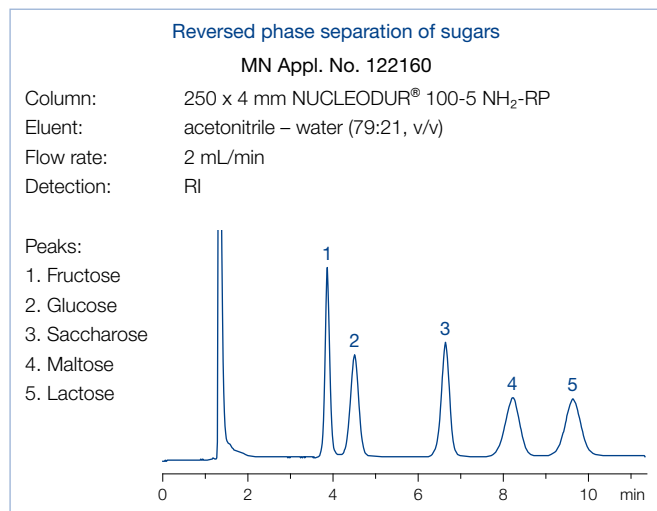

NUCLEODUR[®] NH₂, too, belongs to the so-called multimode columns. It can be used for RP chromatography of polar compounds such as sugars in aqueous-organic eluent systems, for NP chromatography of substituted aromatics or chlorinated pesticides with organic mobile phases such as hexane, dichloromethane or 2-propanol, but also for ion exchange chromatography of anions and organic acids using conventional buffers and organic modifiers.

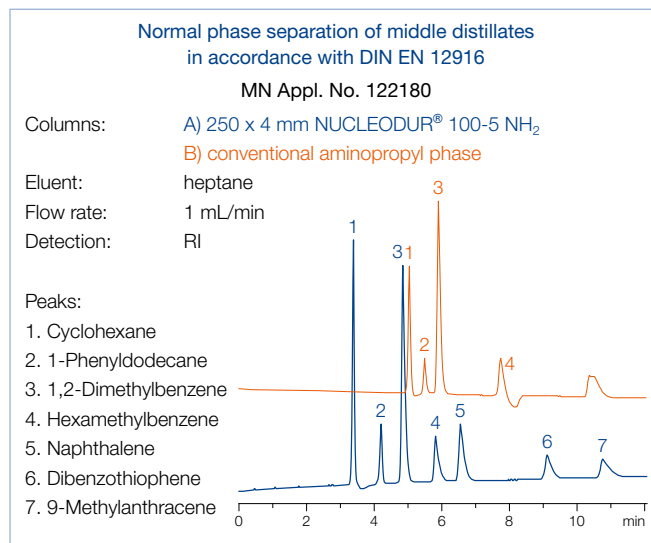

Due to the special method of surface modification NUCLEODUR[®] NH₂ features a pronounced stability at higher as well as at lower pH values. The following figure shows, that even after several days of exposure of the column material at pH 1.75 good separation efficiency and peak symmetry are maintained. The resulting high column life allows cost reduction due to lower column consumption.

This example shows the enhanced pH stability of NUCLEODUR[®] NH₂ and the outstanding suitability for the separation of total herbicides (AMPA, glyphosate, glufonate, ...) – see application 122190 in our online data base at www.mn-net.com/apps.



Hydrolytical resistance of NUCLEODUR® NH₂-RP

Column: 250 x 4 mm NUCLEODUR® 100-5 NH₂-RP
 Eluent: acetonitrile – 50 mmol/L KH₂PO₄, pH 1.75 (50:50, v/v)
 Flow rate: 0.6 mL/min
 Detection: UV, 254 nm

Peaks:
 1. Aminomethylphosphonic acid (AMPA)

after 3872 min
 1st injection

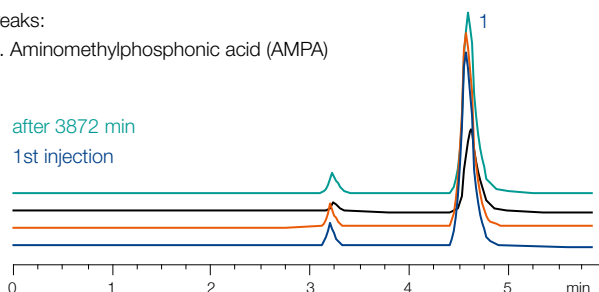

Separation of DNA bases



MN Appl. No. 122170

Column: 250 x 4 mm
 NUCLEODUR®
 100-5 NH₂-RP
 Eluent: acetonitrile – water (80:20, v/v)
 Flow rate: 0.6 mL/min
 Temperature: 35 °C
 Pressure: 30 bar
 Detection: UV, 254 nm

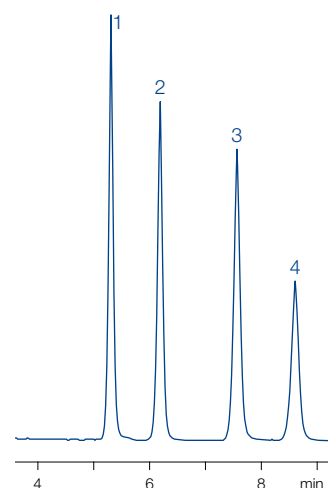
Peaks:
 1. Thymine
 2. Uracil
 3. Cytosine
 4. Adenine



Based on superspherical NUCLEODUR® this phase features a high pressure stability, which makes it the perfect choice for preparative separations as well as for LC/MS. Additionally, the high batch-to-batch reproducibility of NUCLEODUR® NH₂ enables reliable analyses especially for routine work.

ID	Length → 100 mm	125 mm	150 mm	250 mm
NUCLEODUR® 100-3 NH ₂ -RP; particle size 3 µm; eluent in column acetonitrile – water				
Analytical EC columns				
	2 mm	760740.20	760741.20	
	4.6 mm		760742.46	760739.46
EC guard columns*	4 x 2 mm: 761951.20		4 x 3 mm: 761951.30	
NUCLEODUR® 100-5 NH ₂ -RP; particle size 5 µm; eluent in column acetonitrile – water				
Analytical EC columns				
	2 mm	760730.20		760732.20
	3 mm	760730.30		760732.30
	4 mm	760730.40		760732.40
	4.6 mm	760730.46	760731.46	760732.46
EC guard columns*	4 x 2 mm: 761953.20		4 x 3 mm: 761953.30	
NUCLEODUR® 100-5 NH ₂ ; particle size 5 µm; eluent in column n-heptane				
Analytical EC columns				
	4 mm	760720.40		760722.40
	4.6 mm	760720.46	760721.46	760722.46
EC guard columns*	4 x 3 mm: 761952.30			

EC columns in packs of 1, guard columns in packs of 3.

Guard column system

Guard columns for EC columns with ID	2 mm	3 mm	4 mm	4.6 mm	Guard column holder
* Column Protection System (pack of)	EC 4/2 (3)	4/3 (3)	4/3 (3)	4/3 (3)	718966

For details of our column systems see page 258.

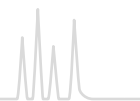

NUCLEODUR[®] SiOH unmodified silica for normal phase · USP L3

★ Key feature

- Totally spherical high purity silica
- Pressure stable up to 600 bar
- Suitable for analytical and preparative separation of polar and midpolar compounds



🔧 Technical data

- Unmodified high purity silica; pore size 110 Å; particle sizes 3 to 50 µm; pore volume 0.9 mL/g; surface area (BET) 340 m²/g; pH stability 2–8; metal content < 10 ppm (see page 150)

✓ Recommended application

- Polar and midpolar compounds under normal phase conditions

Eluent in column *n*-heptane

ID	Length →			
	50 mm	125 mm	150 mm	250 mm
NUCLEODUR[®] 100-3; particle size 3 µm				
Analytical EC columns				
	4.6 mm	760170.46	760172.46	760173.46
EC guard columns*	4 × 3 mm: 761966.30			
NUCLEODUR[®] 100-5; particle size 5 µm				
Analytical EC columns				
	4 mm			760007.40
	4.6 mm	760023.46	760012.46	760007.46
EC guard columns*	4 × 3 mm: 761967.30			
Preparative VarioPrep columns				
	10 mm	762077.100	762078.100	762007.100
	21 mm	762077.210	762078.210	762007.210
	40 mm		762075.400	762007.400
VP guard columns *	10 × 8 mm: 762094.80		10 × 16 mm: 762094.160	
	15 × 32 mm: 762330.320			
EC and VarioPrep columns in packs of 1, guard columns see below.				

Guard column systems

Guard columns for EC columns with ID	2 mm	3 mm	4 mm	4.6 mm	Guard column holder
* Column Protection System (pack of)	EC 4/2 (3)	4/3 (3)	4/3 (3)	4/3 (3)	718966
Guard columns for VarioPrep columns with ID	8, 10 mm	16, 21 mm	32, 40 mm	≥ 50 mm	
** VP guard columns (pack of)	VP 10/8 (2)	10/16 (2)	15/32 (1)	15/50 (1)	
VP guard column holder	718251	718256	718253	718255	

For details of our column systems see page 258.

Unmodified NUCLEODUR[®] bulk material in 10–50 µm for self-packing of preparative columns see page 264.

**MACHEREY-NAGEL**

your partner in HPLC · also online

Besides to this catalog our website provides useful information

- Applications
Database without registration, with more than 3000 free chromatography applications for your separation task.
- Instruction manuals
General advises for column care and individual column cleaning are available in the attached instruction manual or online.
- HPLC troubleshooting
Sometimes during chromatographic separation unexpected effects occur. We give advise of possible reasons and how to avoid or remedy these.
- Flyers, brochures, catalogs
Our product information is available online as PDF file at any time.



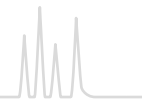

Core-shell technology

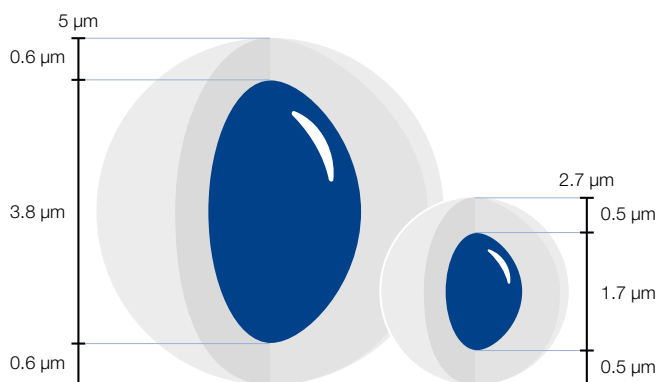

Demands on HPLC separations are constantly increasing with respect to separation efficiency, detection limits, and the time requirements for each analysis.

Several approaches have been made to achieve fast separations without losing chromatographic performance. HPLC columns packed with particles < 2 µm show very high efficiencies (plates/meter) and allow the use of smaller column sizes with the positive side effect of significant solvent saving. However they generate a high back pressure of the mobile phase during column runs which requires specifically designed equipment.

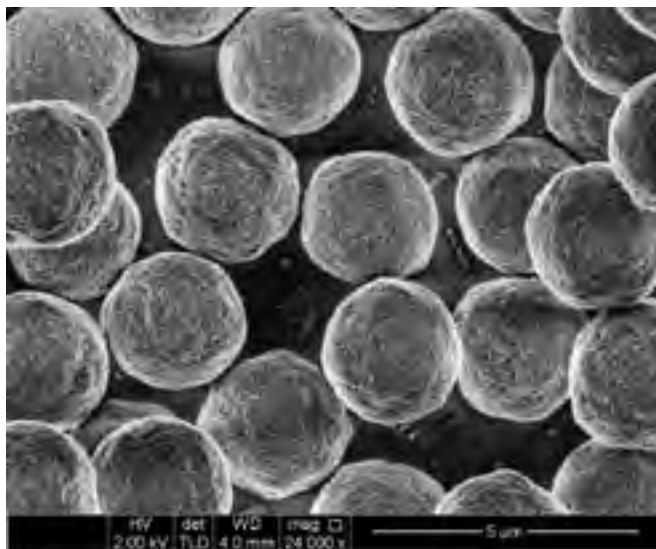

Electron microscopic image of NUCLEOSHELL®

NUCLEOSHELL® silica particles consist of a non-porous solid core of 1.7 µm diameter and a porous outer shell of 0.5 µm thickness. Accordingly the total diameter of the particle is 2.7 µm.

Utilizing a proprietary process of synthesis, NUCLEOSHELL® particles exhibit a distinct narrow particle size distribution ($d_{90}/d_{10} \sim 1.1$). Columns packed with NUCLEOSHELL® core shell

★ Key feature

- Solid core of silicon dioxide, homogeneous shell of porous silica
- Highest efficiency compared to traditional totally porous materials
- Pore size 90 Å; particle size 2.7 µm (core 1.7 µm) and 5 µm (core 3.8 µm); specific surface 130 (2.7 µm) and 90 (5 µm) m²/g lower back pressure enables use on conventional LC systems
- Pressure stability 600 bar

particles feature exceptional separation efficiencies with theoretical plate numbers easily comparable to totally porous sub 2 micron particles.

$$R_s = \frac{\sqrt{N}}{4} \left(\frac{\alpha - 1}{\alpha} \right) \left(\frac{k'_i}{k'_i + 1} \right)$$

R_s = resolution, α = selectivity (separation factor), k'_i = retention
 N = plate number with $N \propto 1/d_p$, d_p = particle diameter

Resolution R_s as function of particle size

MN Appl. No. 125270

Columns: 50 x 4 mm
 NUCLEOSHELL® RP 18, 2.7 µm
 NUCLEODUR® C₁₈ Gravity, 3 µm
 NUCLEODUR® C₁₈ Gravity, 1.8 µm

Eluent: acetonitrile – water (60:40, v/v)
 Flow rate: 1 mL/min
 Temperature: 25 °C
 Detection: UV, 254 nm

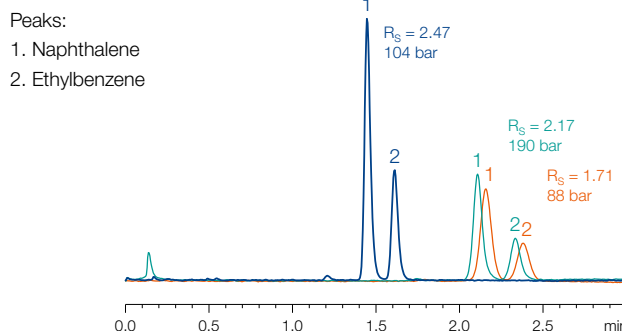



Theoretical column efficiency (optimal conditions)

Silica	d _p [μm]	L [m]	HETP [μm]	Efficiency [plates/m]	L [mm]	N	R _s	Analysis time
NUCLEOSHELL®	2.7	1	4	250,000	100	25,000	112 %	40 %
	5	1	6.5	154,000	150	23,000	115 %	60 %
NUCLEODUR®	1.8	1	4.5	222,222	100	22,000	105 %	40 %
	3	1	7.5	133,333	150	20,000	100 %	60 %
	5	1	12.5	80,000	250	20,000	100 %	100 %

Benefits of core-shell technology

Core-shell particles vs. totally porous silica

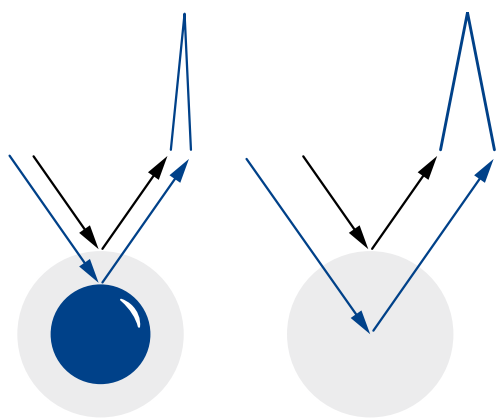

With conventional fully porous particles the mass transfer between stationary and mobile phase usually results in peak broadening at higher flow rates (C-term in van Deemter equation). The short diffusion paths in the core-shell particles reduce the

The van Deemter plots demonstrate how efficiency is affected by flow rate.

In comparison with fully porous silicas, core-shell particles from various manufacturers maintain the efficiency optimum (max. plates/m) over a long range of increasing linear mobile phase velocity.

$$H = A + \frac{B}{u} + C \cdot u$$

A term = eddy-diffusion, B term = longitudinal diffusion coefficient, C term = mass transfer coefficient

Short diffusion paths

- Fast mass transfer (term C of Van Deemter equation)
- High flow velocity without peak broadening for fast LC

Narrow particle size distribution (d₉₀/d₁₀ ~ 1.1)

- Stable packing

High heat transfer

- Minimized influence of frictional heat
- Efficiency of NUCLEOSHELL® ~ 250 000 m⁻¹ (HETP ~ 4 μm)

dwelt time of the analyte molecules in the stationary phase, so that even at high flow velocities of the mobile phase, optimal separation results can be obtained.

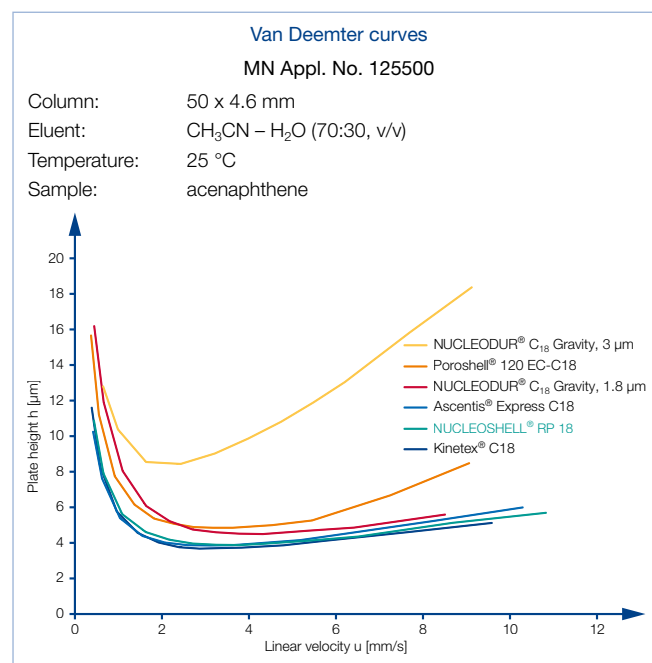

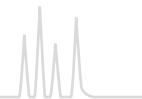

In direct comparison with conventional sub 2 micron phases, NUCLEOSHELL® columns only generate about 60 % of the back pressure and can be operated with the majority of conventional HPLC systems. In order to develop the maximum performance of NUCLEOSHELL® columns, we recommend reducing extra column voids by using suitable capillaries (< 0.15 mm inner diameter) and specially adapted detector cells. Moreover detector settings should be optimized by increasing the measuring rate or by decrease of the time constant.

$$\Delta_p = \frac{\Phi \cdot L_C \cdot \eta \cdot u}{d_p^2}$$

Δ_p = pressure drop, Φ = flow resistance (non-dimensional), L_C = column length, η = viscosity, u = linear velocity, d_p = particle diameter

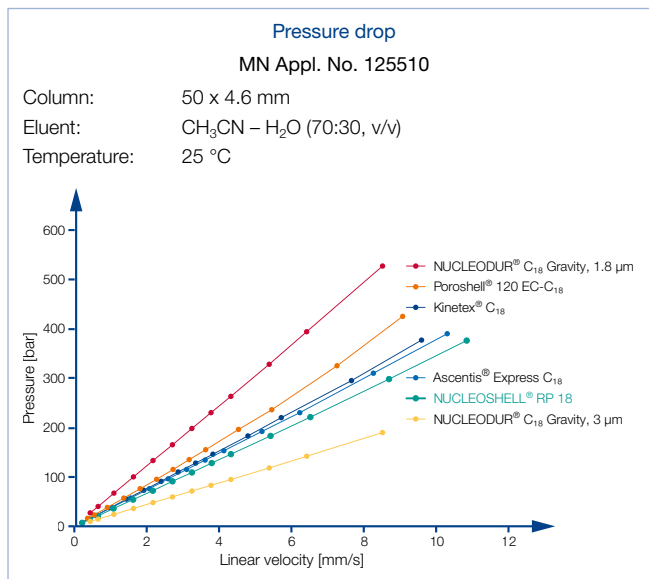

Core-shell particle technology from MACHERY-NAGEL is an alternate route to gain highest column efficiency and resolution in HPLC at short run time, but with moderate back pressure.

Features of NUCLEOSHELL® particles

A criterion for the long-term stability of the column at pH extremes is the percentage decrease of initial retention and initial plates, respectively.

The following figure shows a column stability test of NUCLEOSHELL® RP 18 at mobile phase levels pH 1 and pH 10 compared with three competing phases.



Stability under acidic and basic conditions

MN Appl. Nos. 125520 / 125530

Columns: 50 x 4.6 mm NUCLEOSHELL® RP 18, 2.7 µm
50 x 4.6 mm Kinetex® 2.6 µm C18

Eluent: acetonitrile – 1 % TFA in water,
pH 1 (50:50, v/v)

Flow rate: 1.3 mL/min

Temperature: 80 °C

Detection: UV, 254 nm

Analyt: anthracene

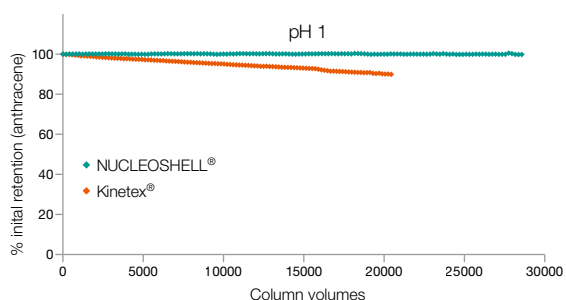

Columns: 50 x 4.6 mm NUCLEOSHELL® RP 18, 2.7 µm
50 x 4.6 mm Ascentis® Express C18, 2.7 µm
50 x 4.6 mm Poroshell® 120 EC-C18
50 x 4.6 mm Kinetex® 2,6 µm C18

Eluent: 20 mmol/L Na borate – 10 mmol/L NaOH – methanol,
pH 10 (21:49:30, v/v/v)

Flow rate: 1.5 mL/min

Temperature: 40 °C

Detection: UV, 220 nm

Analyt: toluidine

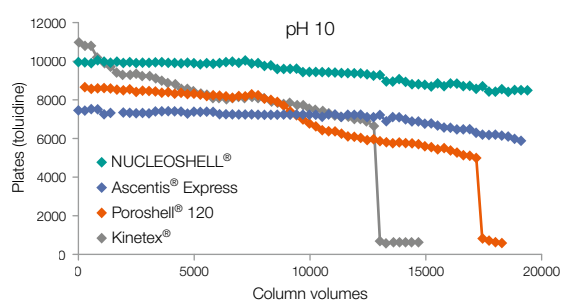

Columns can be operated at elevated temperatures without loss in retention, efficiency or peak symmetry.

Temperature stability

MN Appl. No. 125400

Stability test:

Column: 50 x 2 mm NUCLEOSHELL® RP 18, 2.7 µm
Eluent: A) 10 mmol/L ammonium formate – methanol (9:1, v/v) + 120 µL formic acid, ~ pH 4
B) 10 mmol/L ammonium formate – methanol (1:9, v/v) + 120 µL formic acid, ~ pH 4
0 – 100 % B in 7 min

Flow rate: 0.5 mL/min,

Temperature: 100 °C

Detection: UV, 220 nm

Peaks:

- Phenol
- Naphthalene

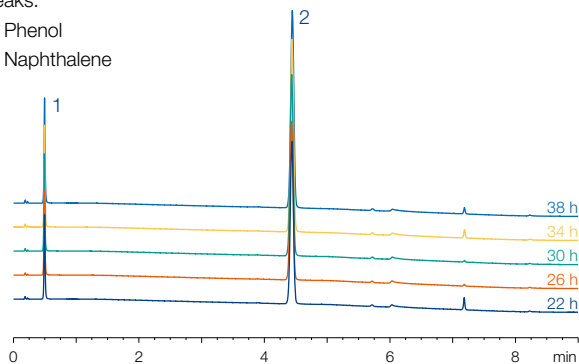

Efficiency test:

Eluent: acetonitrile – water (60:40, v/v)

Flow rate: 0.33 mL/min;

Temperature: 25 °C

Detection: UV, 254 nm

Analyte: anthracene

	HETP [µm]	Asymmetry
Start (t = 0)	5.2	0.98
End (t = 40 h)	5.2	1.01



NUCLEOSHELL® core-shell silica for HPLC

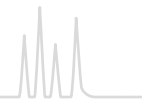

Uniformly shaped NUCLEOSHELL® particles combined with optimized bonding technology safeguard tightly packed columns for 100 % reproducible results.

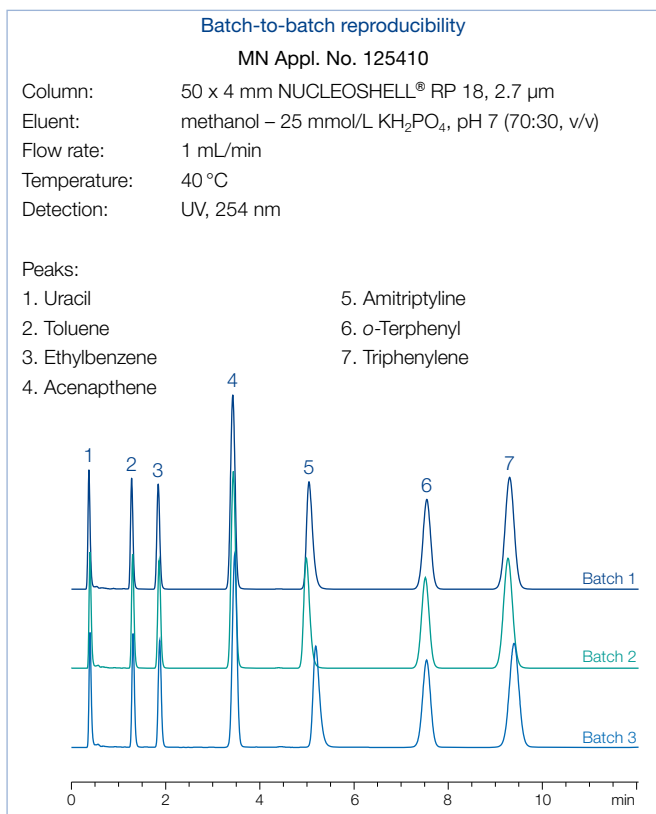

Peak capacity

The peak capacity is a measure for the number of sample analytes that can be separated on HPLC columns per time unit. Narrow peaks increase the peak capacity and thus the efficiency of the analytical column.

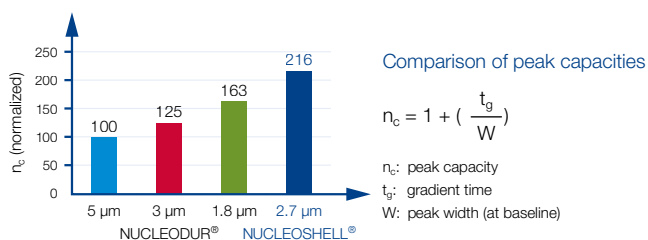

The example shows, that in comparison with totally porous NUCLEODUR® silica (1.8 µm) NUCLEOSHELL® provides 33 % higher peak capacity.

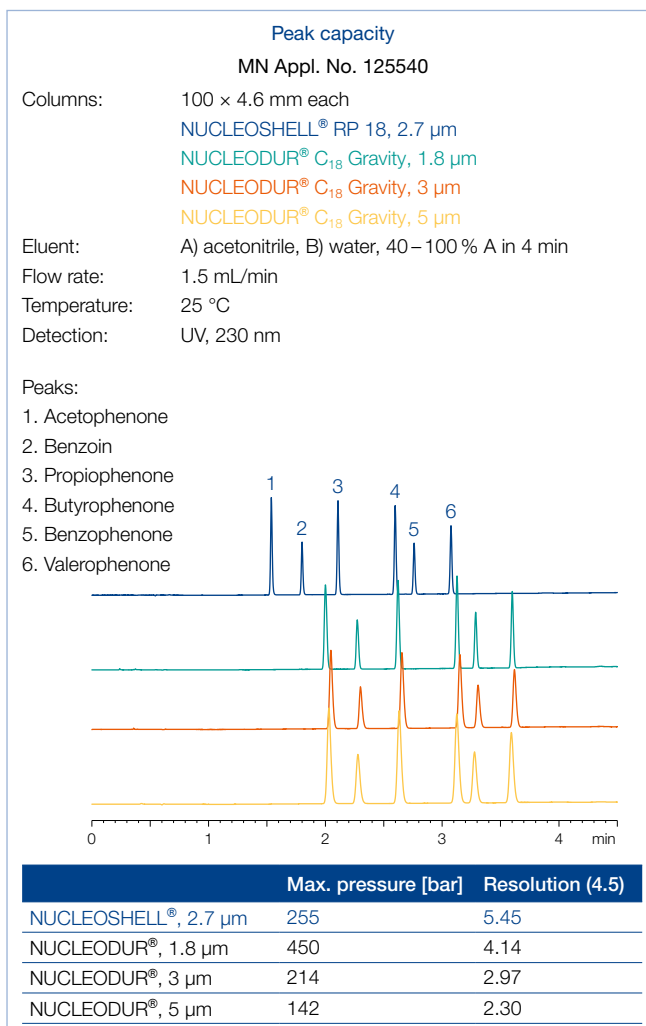

Loading capacity

NUCLEOSHELL® columns allow reliable quantification in a wide analytical detection range. Retention time and peak width at 50 % height remain constant with increasing columns load although core-shell particles are suspected of showing a slightly lower loading capacity compared to fully porous silica materials.

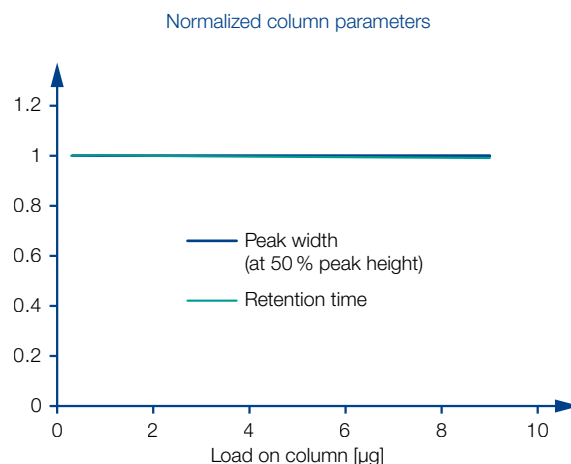



Loading capacity

Column: 50 x 3 mm NUCLEOSHELL® RP 18, 2.7 µm
 Eluent: acetonitrile – 25 mmol/L KH₂PO₄, pH 3
 (70:30, v/v)
 Flow rate: 0.66 mL/min
 Temperature: 30 °C
 Detection: UV, 285 nm

Peaks:
 1. Valerophenone

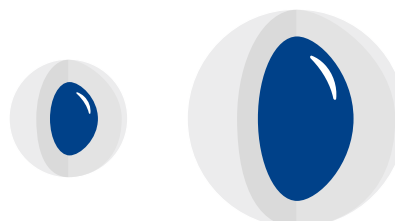
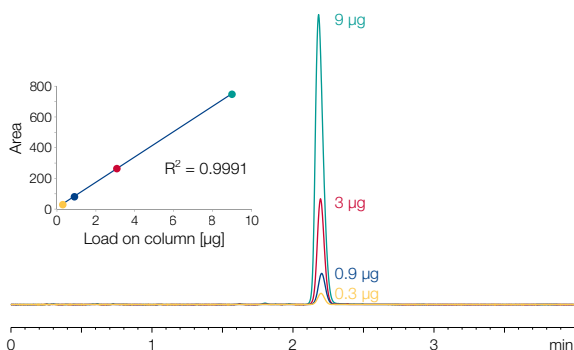

Method transfer of 5 µm particle columns

NUCLEOSHELL® is also available in 5 µm particle size to offer all benefits of core-shell technology to all applications which are bound to particle size.

Separation of cephalosporin antibiotics

MN Appl. No. 126630

Comparison of 5 µm core-shell and totally porous phase

Columns: each 100 x 4.6 mm
 A) NUCLEOSHELL® RP 18plus, 5 µm
 B) NUCLEODUR® Gravity C₁₈, 5 µm
 Eluent: methanol – water + 0.1 %
 formic acid (35:65, v/v)
 Flow rate: 1.3 mL/min
 Pressure: 182 bar, 219 bar
 Temperature: 25 °C
 Detection: UV, 254 nm
 Injection: 4.0 µL

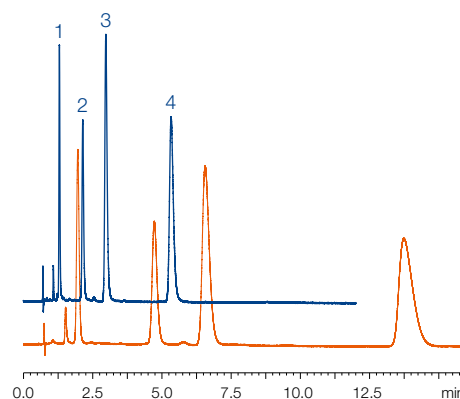







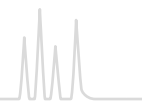



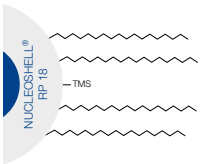

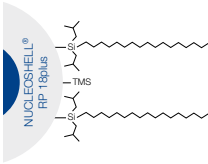
Peaks:	Ret. time [min]		Asymmetry (EP)		Plates (EP)	
	A	B	A	B	A	B
1 Cefotaxime	1.30	1.96	1.19	1.12	6800	2218
2 Cefoxitin	2.14	4.72	1.22	1.20	6599	3471
3 Cefamandole	2.97	6.57	1.24	1.25	6259	3367
4 Cefalotine	5.33	13.73	1.32	1.61	6948	3672

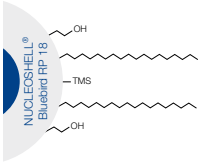

NUCLEOSHELL® phase overview

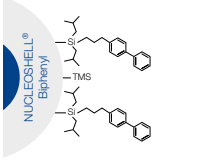

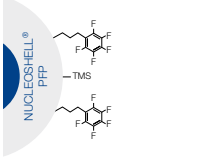
Overview of NUCLEOSHELL® HPLC phases

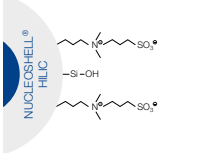
Phase	Specification	Page	Characteristic*	Stability	Structure
 RP 18	octadecyl, multi-endcapping 7.8 % C (2.7 µm particles) 6.1 % C (5 µm particles) USP L1	200	A ●●●●● B ● C ●●●	pH 1–11, suitable for LC/MS	NUCLEOSHELL® (Si-O) ₂ /n 
 RP 18plus	octadecyl (monomeric), multi-endcapping 5.7 % C (2.7 µm particles) 4.4 % C (5 µm particles) USP L1	202	A ●●●●● B ●●● C -	pH 2–9, suitable for LC/MS	NUCLEOSHELL® (Si-O) ₂ /n 
 Bluebird RP 18	octadecyl, hydrophilic endcap- ping 5 % C (2.7 µm particles) USP L1	204	A ●●●●● B ●●● C ●●	stable in 100 % aqueous eluent, pH 1–8, suitable for LC/MS	NUCLEOSHELL® (Si-O) ₂ /n 
 Phenyl-Hexyl	phenylhexyl, multi-endcapping 4.5 % C (2.7 µm particles) USP L11	207	A ●● B ●●●● C ●	pH 1–10, suitable for LC/MS	NUCLEOSHELL® (Si-O) ₂ /n 
 Biphenyl	biphenylpropyl, multi-endcapping 5.2 % C (2.7 µm particles) USP L11	209	A ●●●● B ●●●● C ●●●	stable in 100 % aqueous eluent, pH 1.5–8.5, suitable for LC/MS	NUCLEOSHELL® (Si-O) ₂ /n 
 PFP	pentafluorophenyl, multi-end- capping ~ 3 % C (2.7 µm particles) USP L43	212	A ●● B ●●●●● C ●●●●●	pH 1–9, suitable for LC/MS	NUCLEOSHELL® (Si-O) ₂ /n 
 HILIC	zwitterionic ammonium-sulfonic acid, no endcapping 1.3 % C (2.7 µm particles)	214	A ● B ●●●●● C -	pH 2–8.5, suitable for LC/MS	NUCLEOSHELL® (Si-O) ₂ /n 

* A = ● hydrophobic selectivity, B = ● polar / ionic selectivity, C = ● steric selectivity

** phases which provide a similar selectivity based on chemical and physical properties

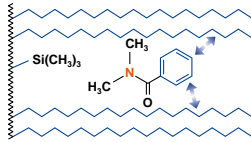
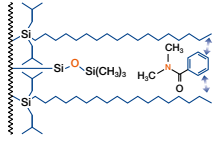
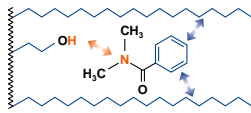
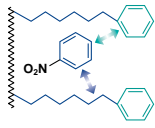
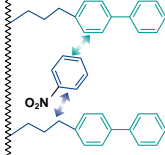
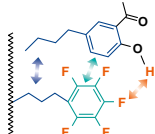
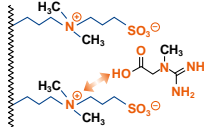

Application	Similar phases**	Interactions · retention mechanism
overall sophisticated analytical separations, e. g., analgesics, anti-inflammatory drugs, antidepressants; herbicides; phytopharmaceuticals; immunosuppressants	Kinetex® C18; Cortecs® C18; Raptor® C18; Accucore® C18; Ascentis® Express C18; HALO® C18; Shim-pack Velox® C18	hydrophobic (van der Waals interactions) 
overall sophisticated analytical separations, especially for polar compounds, e. g., pharmaceuticals like antibiotics, water-soluble vitamins, organic acids	Kinetex® XB-C18; Bonshell® ASB-C18; Raptor® ARC-C18; Shim-pack Velox® SP-18	hydrophobic (van der Waals interactions) 
overall sophisticated analytical separations, especially for very polar compounds, e. g., pesticides, sweeteners, nitrosamines, water-soluble vitamins, organic acids, pharmaceuticals	Kinetex® Polar C ₁₈	hydrophobic and polar (H bonds) 
aromatic and unsaturated compounds, polar compounds like pharmaceuticals, antibiotics	Ascentis® Express Phenyl-Hexyl; Kinetex® Phenyl-Hexyl; Accucore® Phenyl-Hexyl; Ultracore® Phenyl-Hexyl; Poroshell® Phenyl-Hexyl; HALO® Phenyl-Hexyl	π-π and hydrophobic 
aromatic and unsaturated compounds, mycotoxins, phthalates, hormones, polar compounds like pharmaceuticals, antibiotics, pesticides	Kinetex® Biphenyl, Raptor® Biphenyl, HALO® Biphenyl; Shim-pack Velox® Biphenyl	π-π and hydrophobic 
aromatic and unsaturated compounds, phenols, halogenated hydrocarbons, isomers, polar compounds like pharmaceuticals, antibiotics	Kinetex® PFP; Ascentis® Express F5; Accucore® PFP; Shim-pack Velox® PFP; HALO® PFP; Raptor® PFP	polar (H bond), dipole-dipole, π-π and hydrophobic 
hydrophilic compounds such as organic polar acids and bases, polar natural compounds	–	ionic / hydrophilic and electrostatic 

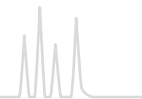

NUCLEOSHELL® RP 18 nonpolar high density phase · USP L1

★ Key feature

- Core-shell technology for fast and efficient HPLC
- Suitable for LC/MS and HPLC at pH extremes (pH 1 – 11)
- Superior base deactivation, ideal for method development

🔧 Technical data

- Octadecyl modification, multi-endcapped; pore size 90 Å, particle size 2.7 and 5 µm, carbon content 7.8 % for 2.7 µm, 6.1 % for 5 µm; pH stability 1 – 11; suitable for LC/MS

✔ Recommended application

- Overall sophisticated analytical separations, e.g., analgesics, anti-inflammatory drugs, antidepressants; herbicides; phytopharmaceuticals; immunosuppressants

NUCLEOSHELL® RP 18 is based on core-shell silica. A unique derivatization process generates a homogeneous surface with a high density of bonded silanes. The following thorough endcapping suppresses any unwanted polar interactions between the silica surface and the sample, which makes NUCLEOSHELL® RP 18 particularly suitable for the separation of basic and other

ionizable analytes. The extremely reduced silanol activity of the phase can be demonstrated by applying basic analytes, such as tricyclic antidepressants. The chromatogram below shows a sharp elution profile (superior resolution!) of these highly polar compounds with an excellent asymmetry value for amitriptyline of 1.12.

Tricyclic antidepressants · comparison of selectivity and resolution

MN Appl. No. 124960

Columns: 50 x 4.6 mm each
 NUCLEOSHELL® RP 18, 2.7 µm
 Ascentis® Express C18
 Kinetex® 2.6 µm C18
 Poroshell® 120 EC-C18

Eluent: methanol – acetonitrile – 25 mmol/L KH₂PO₄, pH 7
 (22.5:22.5:55, v/v/v)

Flow rate: 2 mL/min

Pressure: 224 bar, 239 bar, 248 bar, 212 bar

Temperature: 40 °C

Detection: UV, 220 nm

- Peaks:
1. Protriptyline
 2. Desipramine
 3. Maprotiline
 4. Nortriptyline
 5. Doxepin
 6. Imipramine
 7. Amitriptyline
 8. Clomipramine
 9. Trimipramine

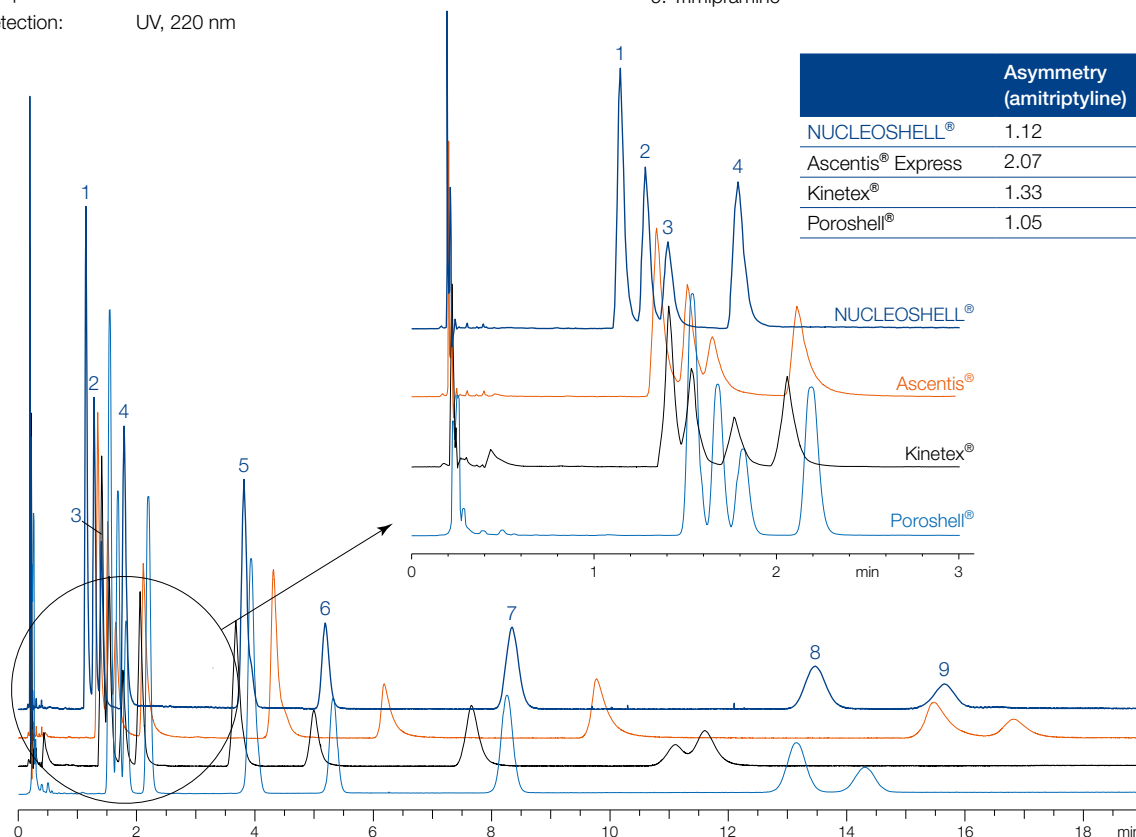

	Asymmetry (amitriptyline)	Resolution (8, 9)
NUCLEOSHELL®	1.12	3.35
Ascentis® Express	2.07	1.91
Kinetex®	1.33	n.a.
Poroshell®	1.05	1.95



NUCLEOSHELL® RP 18 combines innovative silica technology and excellent surface deactivation, that outperforms conventional C₁₈ silicas in terms of efficiency, resolution and speed.



Due to the applied core-shell particle design the back pressure at elevated flow rates remains at a moderate level and in many cases permits the use of existing HPLC equipment. NUCLEOSHELL® RP 18 with extended pH stability, low bleed

characteristics in LC/MS applications, and overall robustness is an ideal tool for method development and routine analyses in modern HPLC.

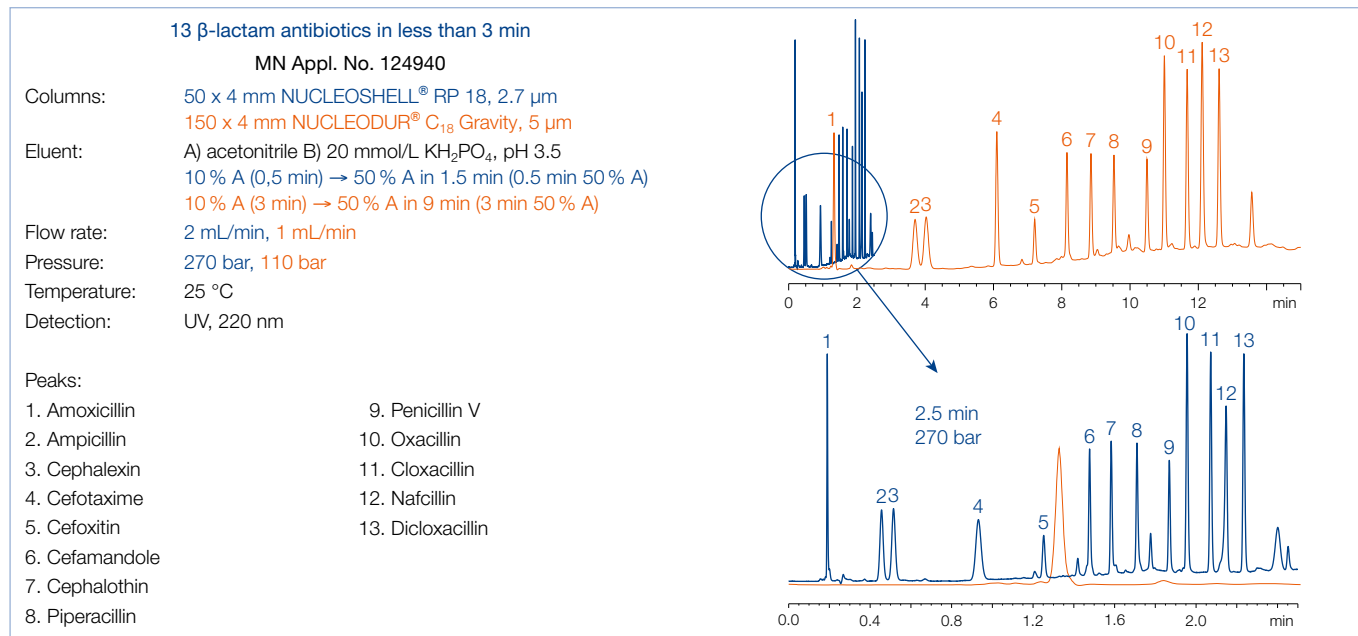
The separation of 13 β-lactam antibiotics illustrates how time of analysis can be shortened to a fractional part by using core-shell particles without loss of resolution at moderate back pressure.



Eluent in column acetonitrile – water

ID	Length →			EC guard columns*	
	50 mm	100 mm	150 mm	250 mm	
NUCLEOSHELL® RP 18, 2.7 μm; particle size 2.7 μm					
Analytical EC columns					
	2 mm	763132.20	763134.20	763136.20	763138.20
	3 mm	763132.30	763134.30	763136.30	763138.30
	4 mm	763132.40	763134.40	763136.40	763138.30
	4.6 mm	763132.46	763134.46	763136.46	763138.30
NUCLEOSHELL® RP 18, 5 μm; particle size 5 μm					
Analytical EC columns					
	2 mm	763152.20	763154.20	763156.20	763158.20
	3 mm	763152.30	763154.30	763156.30	763158.30
	4 mm	763152.40	763154.40	763156.40	763158.30
	4.6 mm	763152.46	763154.46	763156.46	763158.30

EC columns in packs of 1, guard columns in packs of 3.

Guard column system

Guard columns for EC columns with ID		2 mm	3 mm	4 mm	4.6 mm	Guard column holder
* Column Protection System (pack of)	EC	4/2 (3)	4/3 (3)	4/3 (3)	4/3 (3)	718966

For details of the EC column system please see page 258.

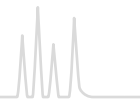

NUCLEOSHELL[®] RP 18plus C₁₈ phase with polar selectivity · USP L1

★ Key feature

- Based on core-shell particle technology for fast and efficient HPLC
- Hydrophobic C₁₈ phase with distinct polar selectivity, ideal for method development
- Excellent performance under highly aqueous conditions

🔧 Technical data

- Monomeric octadecyl modification, multi-encapped; pore size 90 Å, available particle sizes 2.7 µm and 5 µm, carbon content 5.7 % for 2.7 µm, 4.4 % for 5 µm; pH stability 2–9; suitable for LC/MS

✓ Recommended application

- Overall sophisticated analytical separations, especially for polar compounds, e. g., pharmaceuticals like antibiotics, water-soluble vitamins, organic acids

NUCLEOSHELL[®] RP 18plus is a C₁₈ modified core-shell silica. Due to a monomeric bonding chemistry this HPLC phase offers hydrophobic characteristics with distinct polar selectivity. A special derivatization process generates a medium density of bonded silanes with reduced steric selectivity compared to NUCLEOSHELL[®] RP 18.

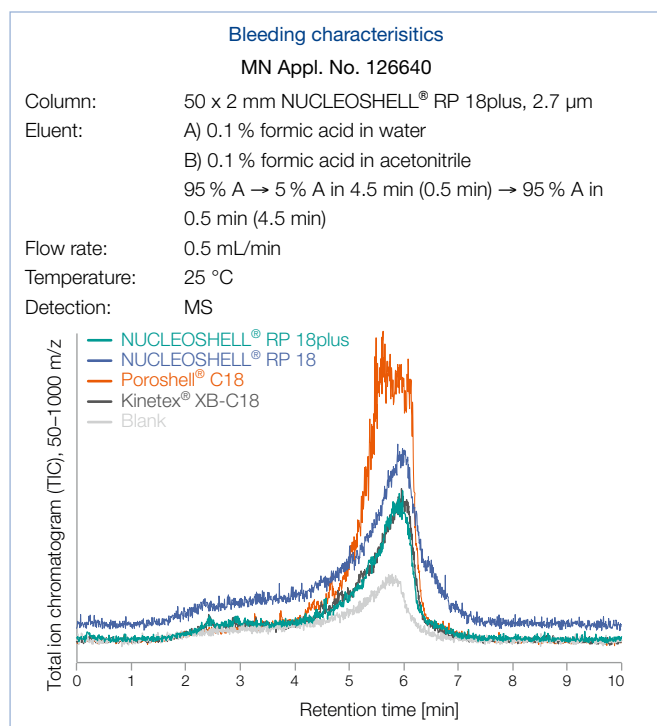

NUCLEOSHELL[®] RP 18plus combines superbly hydrophobic and polar selectivity – so it is a useful tool for method development in RP chromatography. Good pH stability and low bleeding characteristics make it ideal especially for LC/MS applications.

pH stability of NUCLEOSHELL[®] RP 18plus

MN Appl. No. 126650

Column: 100 x 4 mm NUCLEOSHELL[®] RP 18plus, 2.7 µm
Eluent pH 1: 1 % TFA in water – acetonitrile (50:50, v/v)
Eluent pH 9: 50 mmol/L triethylammonium acetate adjusted to pH 9
Flow rate: for pH 1: 0.8 mL/min, for pH 9: 0.56 mL/min
Temperature: for pH 1: 60 °C, for pH 9: 50 °C
Detection: UV, 254 nm
Injection: 1 µL

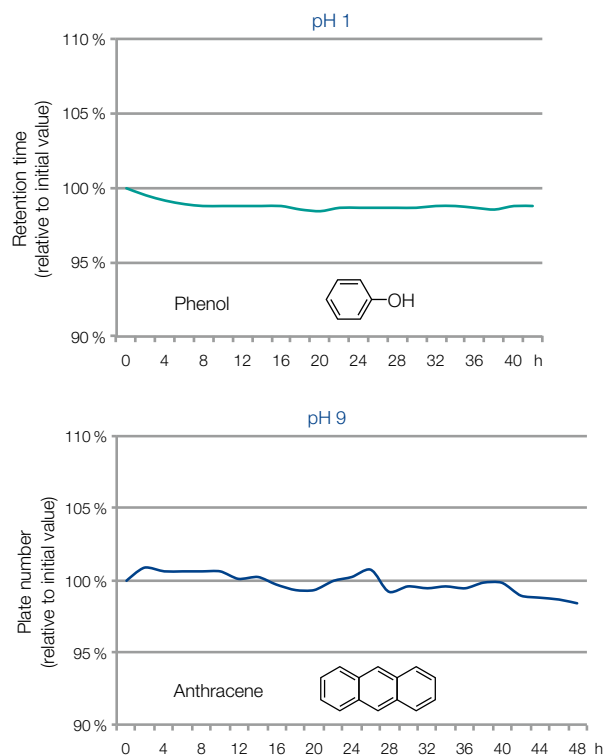

Also a comparison of retention of the glycopeptide antibiotic vancomycin on several octadecyl modified core-shell phases underlines the polar selectivity of NUCLEOSHELL[®] RP 18plus.



Polar selectivity shown for vancomycin

MN Appl. No. 126660

Columns: 50 x 3 mm each
 NUCLEOSHELL® RP 18plus, 2.7 µm
 NUCLEOSHELL® RP 18, 2.7 µm
 Kinetex® 2.6 µm C18

Eluent: water – methanol – acetonitrile – glacial acetic acid (100:8:2:0.3, v/v/v/v) adjusted to pH 3.2 with sodium hydroxide solution

Flow rate: 0.9 mL/min
 Temperature: 35 °C
 Detection: UV, 240 nm
 Injection: 10 µL

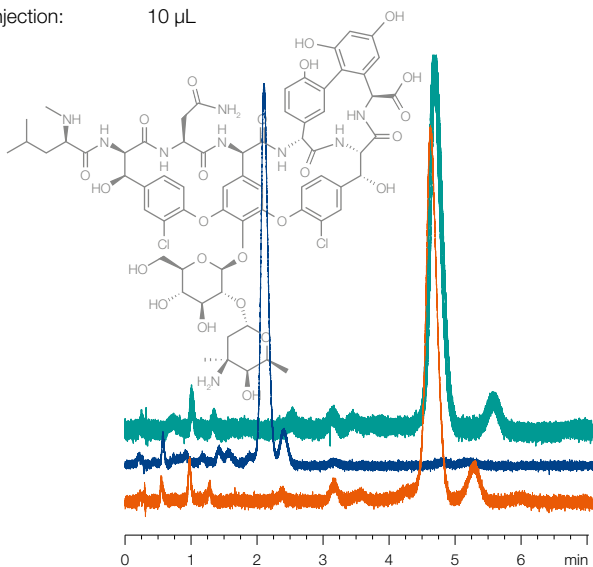

In addition NUCEOSHELL® RP 18plus provides a good stability under highly aqueous conditions. Even by long term usage or storage of the phase phase collapse and loss of retention are hardly observed. The original performance can be regained after a short regeneration procedure.



Phase collapse and regeneration

MN Appl. No. 126670

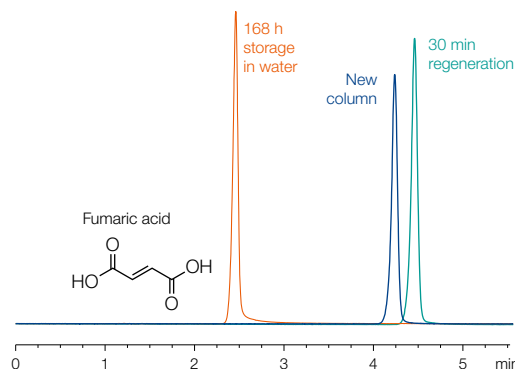
Column: 100 x 4 mm NUCLEOSHELL® RP 18plus, 2.7 µm
 Eluent: 20 mmol/L KH₂PO₄, pH 2.6
 Flow rate: 0.5 mL/min
 Temperature: 20 °C
 Detection: UV, 215 nm
 Injection: 0.5 µL



Eluent in column acetonitrile – water

ID	Length → 50 mm	100 mm			EC guard columns*	
		150 mm	250 mm	500 mm	750 mm	1000 mm
NUCLEOSHELL® RP 18plus, 2.7 µm; particle size 2.7 µm						
Analytical EC columns						
	2 mm	763232.20	763234.20	763236.20	763238.20	
	3 mm	763232.30	763234.30	763236.30	763238.30	
	4 mm	763232.40	763234.40	763236.40	763238.30	
	4.6 mm	763232.46	763234.46	763236.46	763238.30	
NUCLEOSHELL® RP 18plus, 5 µm; particle size 5 µm						
Analytical EC columns						
	2 mm	763252.20	763254.20	763256.20	763257.20	763258.20
	3 mm	763252.30	763254.30	763256.30	763257.30	763258.30
	4 mm	763252.40	763254.40	763256.40	763257.40	763258.30
	4.6 mm	763252.46	763254.46	763256.46	763257.46	763258.30

EC columns in packs of 1, guard columns in packs of 3.

Guard column system

Guard columns for EC columns with ID	2 mm	3 mm	4 mm	4.6 mm	Guard column holder
* Column Protection System (pack of)	EC 4/2 (3)	4/3 (3)	4/3 (3)	4/3 (3)	718966

For details of the EC column system please see page 258.

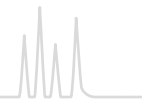

NUCLEOSHELL® Bluebird RP 18 for highly aqueous mobile phases · USP L1

★ Key feature

- Special core-shell phase with hydrophilic endcapping
- Stable in 100 % aqueous mobile phase
- Distinct polar selectivity features
- Excellent base deactivation; suitable for LC/MS due to low bleeding characteristics

NUCLEOSHELL® Bluebird RP 18 is an octadecyl modified superficially porous silica. Due to an excellent base deactivation and a special hydrophilic endcapping procedure, NUCLEOSHELL® Bluebird RP 18 is extremely durable in 100 % aqueous mobile phase.

🔧 Technical data

- Octadecyl phase; polar endcapped
- Pore size 90 Å; particle size 2.7 µm. carbon content 5 %; pH stability 1 – 8

✓ Recommended application

- USP listing L1
- Pesticides, pharmaceuticals, water-soluble vitamins, sweeteners, nitrosamines, organic acids, very polar analytes

A robust bonding chemistry leads to low bleeding characteristics and therefore an excellent suitability for LC/MS applications.

The polar surface chemistry of NUCLEOSHELL® Bluebird RP 18 leads to retention characteristics distinctly different from conventional C₁₈ phases. Sulfa drugs and various polar drug analytes can be very well separated as shown in the following applications (MN application numbers 128340 and 128390).

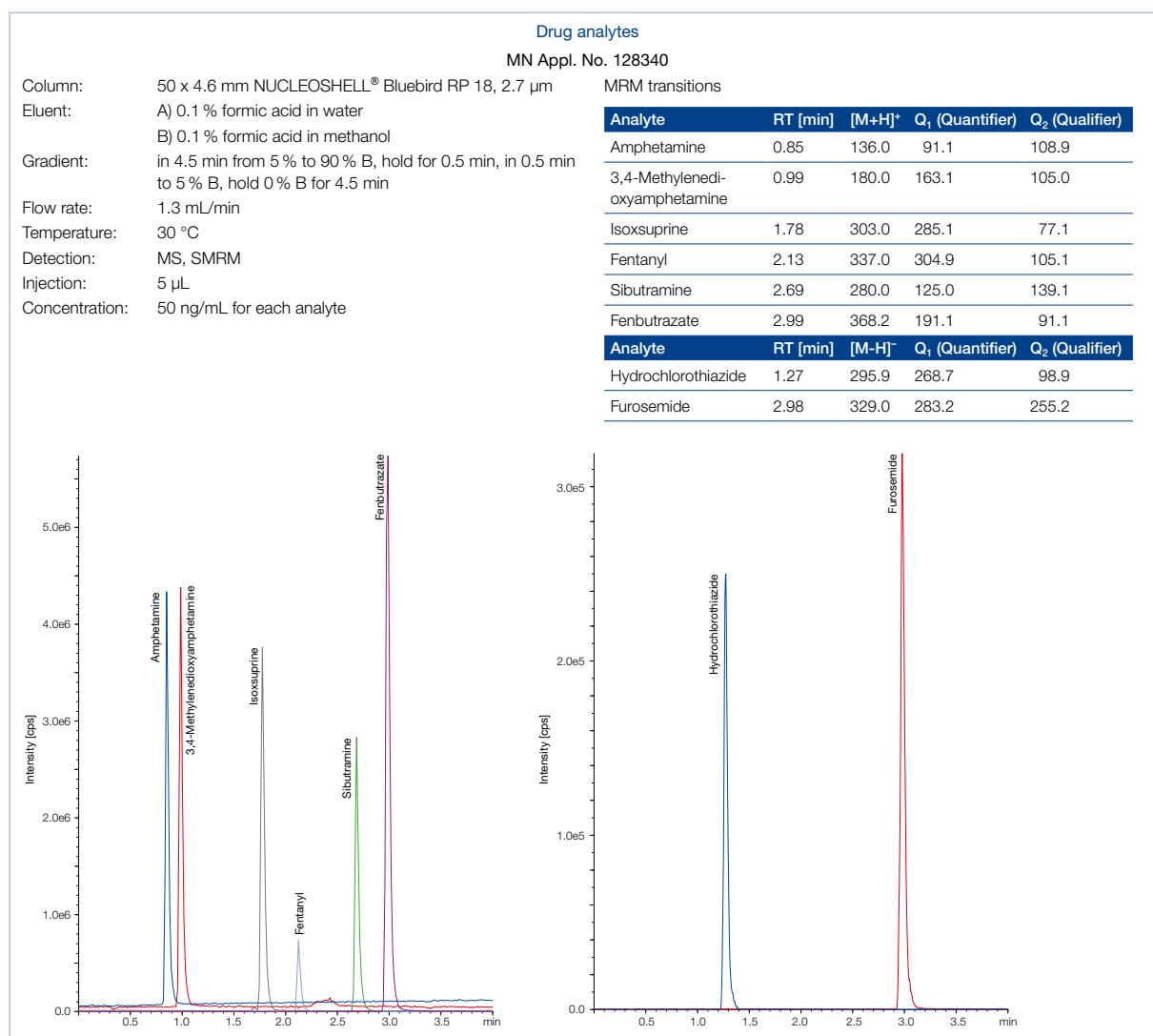



Sulfa drugs

MN Appl. No. 128390

Column: 50 x 4.6 mm NUCLEOSHELL® Bluebird RP 18, 2.7 µm
 Eluent: A) 0.1 % formic acid in water
 B) 0.1 % formic acid in methanol
 Gradient: in 4.0 min from 5 % to 20 % B, in 1.0 min to 80 % B, hold 80 % B for 0.5 min, in 0.1 min to 5 % B, hold 5 % B for 4.4 min
 Flow rate: 1.3 mL/min
 Temperature: 50 °C
 Detection: MS, MRM
 Injection: 5 µL
 Concentration: 100 ng/mL for each analyte

Analyte	RT [min]	[M+H] ⁺	Q ₁ (Quantifier)	Q ₂ (Qualifier)
Sulfadimethoxine	4.03	311.1	156.1	92.1
Sulfaquinoxaline	4.08	301.2	156.1	92.1

MRM transitions

Analyte	RT [min]	[M+H] ⁺	Q ₁ (Quantifier)	Q ₂ (Qualifier)
Sulfacetamide	1.24	215.2	156.2	92.1
Sulfadiazine	1.50	251.2	156.1	92.1
Sulfapyridine	1.69	250.2	156.1	92.0
Sulfatiazole	1.75	256.2	156.2	92.1
Sulfamerazine	1.89	265.1	156.1	92.1
Sulfadimidine	2.22	279.2	185.9	65.0
Sulfamethoxypyridazine	2.46	281.2	156.1	92.2
Sulfamonomethoxine	2.92	281.2	156.1	92.2
Sulfachlorpyridazine	2.96	285.2	156.1	92.1
Sulfamethoxazole	3.31	254.2	156.1	92.1
Sulfadoxine	3.72	311.1	156.1	92.1

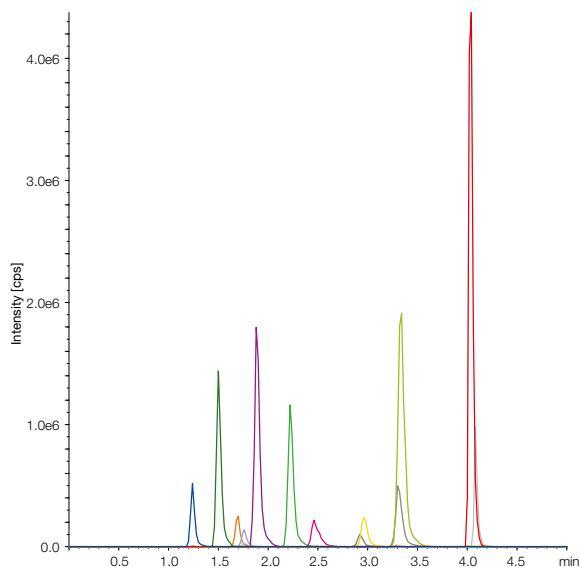

The reliable phase modification process leads to a high batch-to-batch reproducibility, where different batches show very consistent performance results. This can be shown in application 128610 with analytes of different polarities, which also demonstrate the hydrophobic properties of this C₁₈ phase.

Batch-to-batch reproducibility

MN Appl. No. 128610

Column: 50 x 4 mm NUCLEOSHELL® Bluebird RP 18, 2.7 µm
 Eluent: 25 mM ammonium dihydrogen phosphate solution – methanol (35:65, v/v), pH = 7.0
 Flow rate: 1.0 mL/min
 Temperature: 40 °C
 Detection: UV, 254 nm
 Injection: 5 µL
 Concentration:
 Uracil 45 µg/mL
 Ethyl benzoate 181 µg/mL
 Lidocaine 1134 µg/mL
 Naphthalene 1134 µg/mL
 Biphenyl 45 µg/mL
 Acenaphthene 227 µg/mL
 The mixture was diluted to 4 mL with water

- Peaks:
- | | |
|-------------------|-----------------|
| 1. Uracil | 4. Naphthalene |
| 2. Ethyl benzoate | 5. Biphenyl |
| 3. Lidocaine | 6. Acenaphthene |

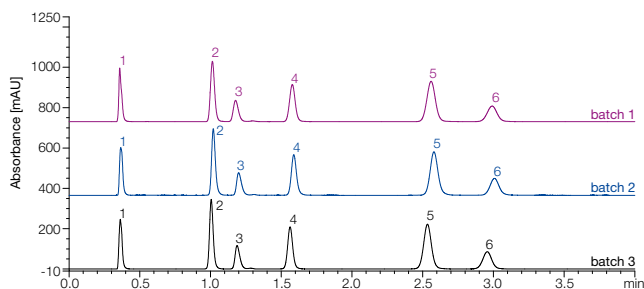

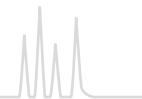

In addition even very polar organic acids can be analyzed while retaining an excellent performance on NUCLEOSHELL® Bluebird RP 18 using 100 % aqueous mobile phase.

Organic acids

MN Appl. No. 128330

Column: 150 x 4 mm NUCLEOSHELL® Bluebird RP 18, 2.7 µm
 Eluent: 50 mM potassium dihydrogen phosphate solution, pH = 2.5
 Flow rate: 2.0 mL/min
 Temperature: 40 °C
 Detection: UV, 210 nm
 Injection: 3 µL

Peaks:
 1. Tartaric acid 2. Malic acid 3. Shikimic acid 4. Lactic acid
 5. Acetic acid 6. Citric acid 7. Fumaric acid 8. Acrylic acid
 9. Arbutin

Concentration (in water)
 Tartaric acid 135 µg/mL
 Malic acid 2162 µg/mL
 Shikimic acid 27 µg/mL
 Lactic acid 2703 µg/mL
 Acetic acid 2703 µg/mL
 Citric acid 1081 µg/mL
 Fumaric acid 41 µg/mL
 Acrylic acid 676 µg/mL
 Arbutin 216 µg/mL

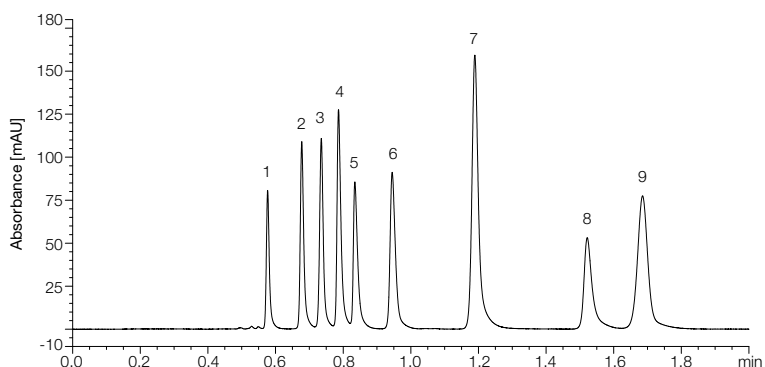

Length (mm)	ID (mm)	Particle size (µm)	REF	Guard columns*
NUCLEOSHELL® Bluebird RP 18 (pack of 1)				
Analytical EC columns				
150	4.6	2.7	763436.46	763438.30
150	4	2.7	763436.40	763438.30
150	3	2.7	763436.30	763438.30
150	2	2.7	763436.20	763438.20
100	4.6	2.7	763434.46	763438.30
100	4	2.7	763434.40	763438.30
100	3	2.7	763434.30	763438.30
100	2	2.7	763434.20	763438.20
50	4.6	2.7	763432.46	763438.30
50	3	2.7	763432.30	763438.30

* Pack of 3, EC guard columns require column protection system REF 718966. For more information, 259



NUCLEOSHELL® Phenyl-Hexyl Alternative selectivity to C₁₈ phases · USP L11

★ Key feature

- Based on core-shell particle technology for fast and efficient HPLC
- Hydrophobic phase with alternative selectivity compared to classical C₁₈ modifications
- Separation principle based on 2 retention mechanisms: π - π interactions and hydrophobic interactions

🔧 Technical data

- Phenyl-Hexyl modification, multi-encapped; pore size 90 Å, particle size 2.7 μ m; carbon content 4.5 %; pH stability 1 – 10; suitable for LC/MS

✔ Recommended application

- Aromatic and unsaturated compounds, polar compounds like pharmaceuticals, antibiotics

Phenyl-Hexyl modified phases offer an excellent separation efficiency especially for aromatic and unsaturated compounds with electron-withdrawing groups. The combination of hydrophobic and π - π interactions results in an alternative and interesting selectivity profile compared to C₁₈ or C₈ modifications. NUCLEOSHELL® Phenyl-Hexyl is based on a unique surface bonding chemistry – therefore it is suitable for LC/MS due to low bleeding characteristics and offers high temperature stability and pH stability from 1 to 10.

Stability of NUCLEOSHELL® Phenyl-Hexyl at pH 10

MN Appl. No. 126420

Column: 50 x 4 mm NUCLEOSHELL® Phenyl-Hexyl, 2.7 μ m
 Eluent: acetonitrile – 50 mmol/L TEA pH 10 (60:40, v/v); pH of the mixture 10.4
 Flow rate: 1 mL/min
 Temperature: 40 °C
 Detection: UV, 254 nm
 Injection: 1 μ L

Peaks:

- Phenol
- Naphthalene
- Anthracene

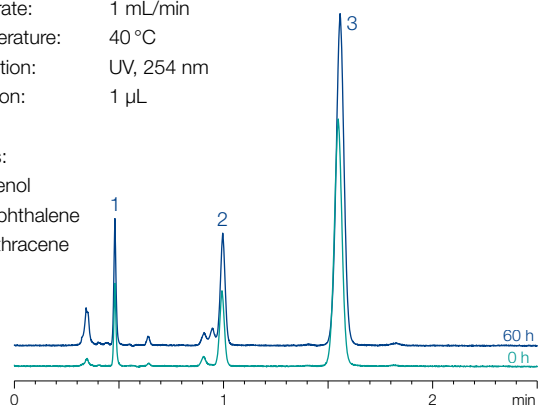

Relative plate numbers

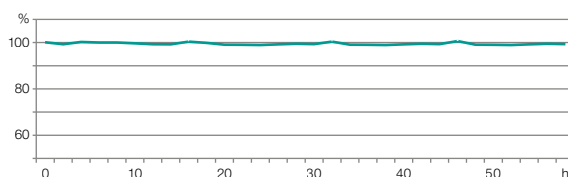

NUCLEOSHELL® Phenyl-Hexyl is a robust phase with an alternative RP selectivity for aromatic and unsaturated analytes compared to classical C₁₈/C₈ phases – it is an additional and useful tool for all chromatography users.

Bleeding characteristics of NUCLEOSHELL® Phenyl-Hexyl

MN Appl. No. 126400

Columns: 50 x 2 mm each
 NUCLEOSHELL® Phenyl-Hexyl, 2.7 μ m
 Kinetex® Phenyl-Hexyl
 Eluent: A) acetonitrile, B) water
 5–95 % A in 25 min
 Flow rate: 0.2 mL/min
 Temperature: 25 °C
 Detection: MS

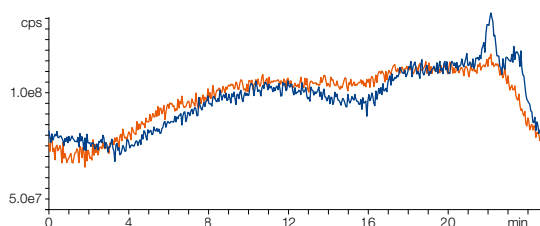

The pyridine-phenol test shows that NUCLEOSHELL® Phenyl-Hexyl provides a symmetrical peak for pyridine and higher resolution in comparison to other core-shell based Phenyl-Hexyl phases, which underlines the excellent base deactivation.

Pyridine-phenol test of NUCLEOSHELL® Phenyl-Hexyl

MN Appl. No. 126410

Columns: 50 x 2 mm each
 NUCLEOSHELL® Phenyl-Hexyl, 2.7 μ m
 Kinetex® Phenyl-Hexyl
 Ascentis® Express Phenyl-Hexyl
 Eluent: acetonitrile – water (70:30, v/v)
 Flow rate: 0.3 mL/min
 Temperature: 40 °C
 Detection: UV, 254 nm
 Injection: 0.2 μ L

Peaks:

- Pyridine
- Phenol

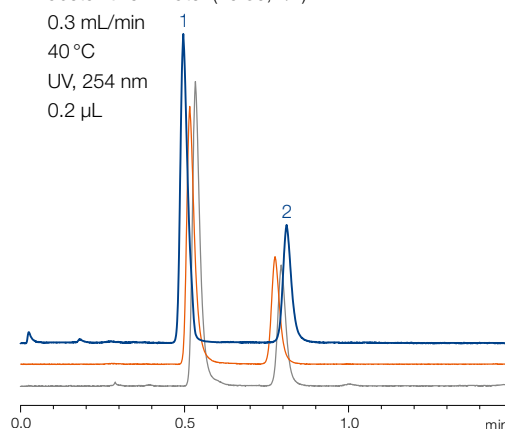

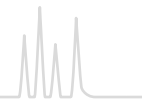

Comparing the separation of sulfonamides on NUCLEODUR® Phenyl-Hexyl with different particle sizes

MN Appl. No. 125860

Columns: 150 x 3 mm each
 NUCLEOSHELL® Phenyl-Hexyl, 2.7 µm
 NUCLEODUR® Phenyl-Hexyl, 1.8 µm
 NUCLEODUR® Phenyl-Hexyl, 3 µm
 NUCLEODUR® Phenyl-Hexyl, 5 µm

Eluent: A) methanol
 B) 0.1 % formic acid in water
 20–80 % A in 10 min

Flow rate: 0.56 mL/min
 Temperature: 40 °C
 Detection: UV, 254 nm
 Injection: 0.5 µL

- Peaks:
1. Sulfadiazine
 2. Sulfachlorpyridazine
 3. Sulfapyridine
 4. Sulfamerazine
 5. Sulfadimidine
 6. Sulfathiazole
 7. Sulfadimethoxine

On NUCLEOSHELL® Phenyl-Hexyl the resolution of the last two peaks is higher than on the fully porous 1.8 µm NUCLEODUR® Phenyl-Hexyl.

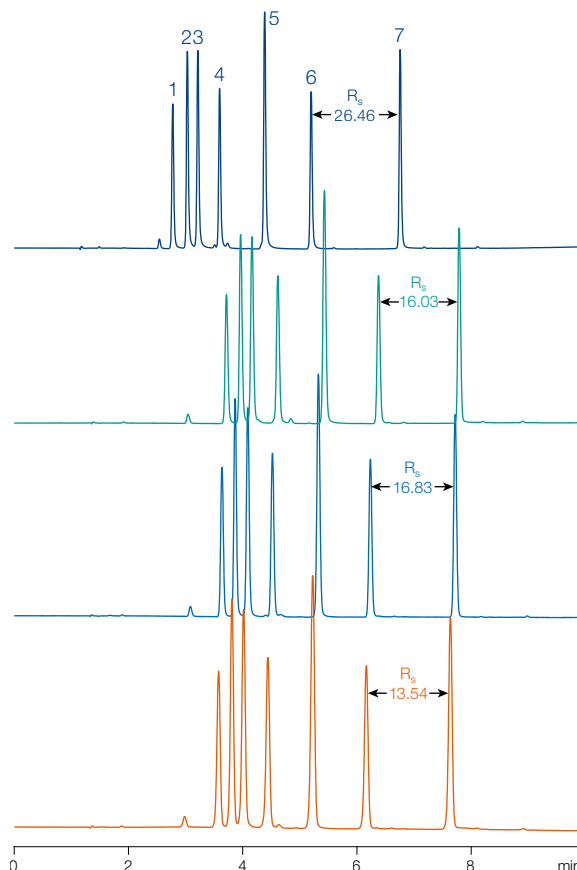

The separation of sulfonamides proves the scalability from fully porous NUCLEODUR® to NUCLEOSHELL® Phenyl-Hexyl. Hereby the core-shell silica exhibits identical selectivity, narrower peaks and slightly shorter retention under the same conditions.

Thus, method transferability between NUCLEODUR® and NUCLEOSHELL® is guaranteed, either for speeding up your methods or scaling up for preparative requirements.

Eluent in column acetonitrile – water

ID	Length →	100 mm			EC guard columns*
		50 mm	100 mm	150 mm	
NUCLEOSHELL® Phenyl-Hexyl, 2.7 µm; particle size 2.7 µm					
Analytical EC columns					
	2 mm	763732.20	763734.20	763736.20	763738.20
	3 mm	763732.30	763734.30	763736.30	763738.30
	4 mm	763732.40	763734.40	763736.40	763738.30
	4.6 mm	763732.46	763734.46	763736.46	763738.30

EC columns in packs of 1, guard columns in packs of 3.

Guard column system

Guard columns for EC columns with ID		2 mm	3 mm	4 mm	4.6 mm	Guard column holder
* Column Protection System (pack of)	EC	4/2 (3)	4/3 (3)	4/3 (3)	4/3 (3)	718966

For details of the EC column system please see page 258.



NUCLEOSHELL® Biphenyl for highly aqueous mobile phases · USP L11

★ Key feature

- Enhanced retention for aromatic and unsaturated substances due to a separation principle based on 2 retention mechanisms: π - π interactions and hydrophobic interactions
- Stable in 100 % aqueous mobile phase systems
- Suitable for LC/MS due to low bleeding characteristics

🔧 Technical data

- Biphenylpropyl phase; multi-encapped
- Pore size 90 Å; particle size 2.7 μ m. carbon content 5.2 %; pH stability 1.5–8.5

✓ Recommended application

- USP listing L11
- Pesticides, pharmaceuticals, mycotoxins, phthalates, hormones, DNPH aldehydes, aromatic and unsaturated compounds

NUCLEOSHELL® Biphenyl is a biphenyl modified superficially porous silica.

The special phase modification of NUCLEOSHELL® Biphenyl with iso-butyl sidechains leads to low bleeding characteristics even at very acidic pH values compared to competitor columns (as shown in application 128780). Due to these iso-butyl sidechains and multi-encapping procedures no phase collapse occurs and stability in 100 % aqueous mobile phase is ensured. Additionally NUCLEOSHELL® Biphenyl shows an excellent suitability for LC/MS applications.

A reliable phase modification process guarantees a high batch-to-batch reproducibility. This can be shown in application 128760 with different analytes. The separation of these compounds with various polarities demonstrates the hydrophobic as well as polar properties of this biphenyl phase.

Stability in acidic medium (gradient method)

MN Appl. No. 128780

Column: 100 x 3 mm NUCLEOSHELL® Biphenyl, 2.7 μ m
 Eluent: A) 1 % H₃PO₄ (pH = 1.2)
 B) acetonitrile
 Gradient: equilibration 10 min 10 % B, hold 10 % B for 5 min, from 10 % to 90 % B in 5 min, hold 90 % B for 3 min, in 1.0 min to 10 % B
 Flow rate: 0.56 mL/min
 Temperature: 40 °C
 Detection: UV, 254 nm
 1. NUCLEOSHELL® Biphenyl, 2.7 μ m
 2. Kinetex® Biphenyl, 2.6 μ m
 3. Raptor® Biphenyl, 2.7 μ m

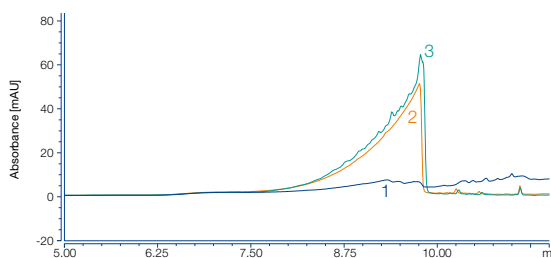

Batch-to-batch reproducibility

MN Appl. No. 128760

Column: 50 x 4 mm NUCLEOSHELL® Biphenyl, 2.7 μ m
 Eluent: 25 mM potassium dihydrogen phosphate solution – methanol (70:30, v/v), pH = 7.0
 Flow rate: 1.0 mL/min
 Run time: 10 min
 Temperature: 30 °C
 Detection: UV, 254 nm
 Injection: 1 μ L

Concentration (in methanol)
 Uracil 40 μ g/mL (void volume marker)
 Toluene 1250 μ g/mL
 Ethylbenzene 1250 μ g/mL
 Lidocaine 500 μ g/mL
 Acenaphthene 230 μ g/mL

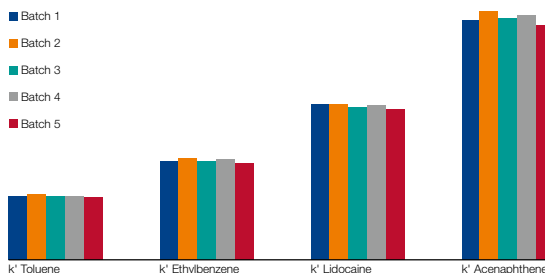

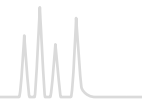

Phthalates

MN Appl. No. 128830

Columns: 100 x 3 NUCLEOSHELL[®] Biphenyl, 2.7 μ m
100 x 3 NUCLEOSHELL[®] Phenyl-Hexyl, 2.7 μ m
100 x 3 NUCLEOSHELL[®] PFP, 2.7 μ m

Eluent: A) water
B) 0.1 % water in acetonitrile

Gradient: hold 50 % B for 1.5 min, in 6.0 min to 95 % B, hold 95 % B for 3.5 min, in 2.0 min to 50 % B, hold 50 % B for 4.5 min

Flow rate: 1.0 mL/min

Temperature: 30 °C

Detection: UV, 228 nm

Injection: 5 μ L

Concentration: 10.0 ng/mL for each analyte in water – acetonitrile (1:1, v/v)

Retention times

Analyte	Biphenyl RT [min]	Phenyl-Hexyl RT [min]	PFP RT [min]
1 Dimethyl phthalate	0.96	0.94	0.86
2 Diethyl phthalate	1.50	1.49	1.20
3 Dipropyl phthalate	2.87	2.80	1.89
4 Dibutyl phthalate	4.09	4.13	2.99
5 Benzyl butyl phthalate	4.24	4.19	3.07
6 Dicyclohexyl phthalate	5.39	5.36	3.78
7 Dioctyl phthalate	6.80	6.87	5.26
8 Dioctyl phthalate	7.44	7.53	5.80

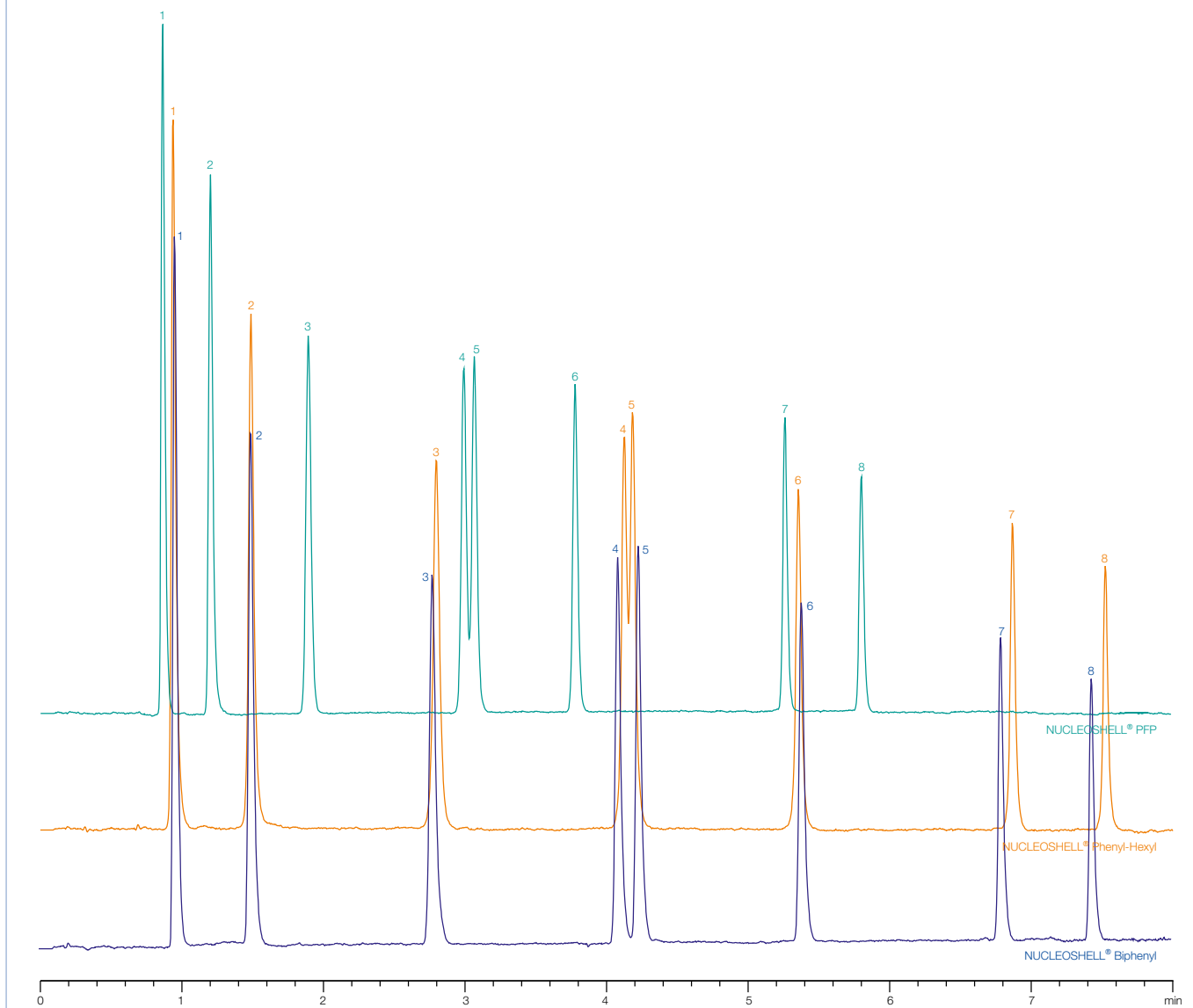

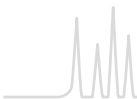

Compared to other aryl HPLC modifications NUCLEOSHELL[®] Biphenyl shows more pronounced π - π interactions. In application 128830 NUCLEOSHELL[®] Biphenyl is able to

separate the critical analyte pair dibutyl phthalate and benzyl butyl phthalate whereas other aryl phases cannot achieve a baseline separation.

Length (mm)	ID (mm)	Particle size (μ m)	REF	Guard columns*
NUCLEOSHELL [®] Biphenyl (pack of 1)				
Analytical EC columns				
150	4.6	2.7	763636.46	763638.30
150	4	2.7	763636.40	763638.30
150	3	2.7	763636.30	763638.30
150	2	2.7	763636.20	763638.20
100	4.6	2.7	763634.46	763638.30
100	4	2.7	763634.40	763638.30
100	3	2.7	763634.30	763638.30
100	2	2.7	763634.20	763638.20
50	3	2.7	763632.30	763638.30
50	2	2.7	763632.20	763638.20

* Pack of 3, EC guard columns require column protection system REF 718966. For more information, see page 259.

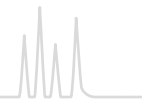

NUCLEOSHELL® PFP hydrophobic pentafluorophenyl phase · USP L43

★ Key feature

- Core-shell technology for fast and efficient HPLC
- Hydrophobic phase with alternative selectivity in comparison to classical C₁₈ modifications
- Separation principle based on 4 retention mechanisms (polar interactions (H bonds), dipole-dipole, π-π, hydrophobic interactions)

🔧 Technical data

- Phase with pentafluorophenylpropyl modification, multi-endcapping; pore size 90 Å, particle size 2.7 μm; carbon content ~ 3%; pH stability 1–9; suitable for LC/MS

✓ Recommended application

- Aromatic and unsaturated compounds, phenols, halogen compounds, isomers, polar compounds like pharmaceuticals, antibiotics; strong retention of basic compounds

Orthogonality in selectivity

Fluorinated stationary phases in HPLC have gained increasing interest over the last years. Most common representative of fluorinated silica phases is the pentafluorophenyl modification (PFP or F₅). Especially the orthogonal selectivity compared to traditional alkyl phases widens the scope in analytical HPLC. Thus NUCLEOSHELL® PFP offers an excellent selectivity especially for highly polar analytes, aromatic and unsaturated compounds, phenols or halogenated hydrocarbons.

While a typical C₁₈ phase just provides hydrophobic interactions between stationary phase and analyte NUCLEOSHELL® PFP offers four different retention mechanisms: polar interactions (H bonds), dipole-dipole interactions, π-π interactions and hydrophobic interactions. Especially the pronounced ion exchange capacity and distinct steric selectivity are typical for the character of fluorinated phases.

Stability of NUCLEOSHELL® PFP at pH 1

MN Appl. No. 125560

Columns: 100 x 4.6 mm NUCLEOSHELL® PFP, 2.7 μm
100 x 4.6 mm Kinetex® PFP, 2.6 μm F5
Eluent: acetonitrile – 0.5 % TFA, pH 1 (50:50, v/v)
Flow rate: 1.3 mL/min
Temperature: 60 °C
Detection: UV, 254 nm
Sample: ethylbenzene

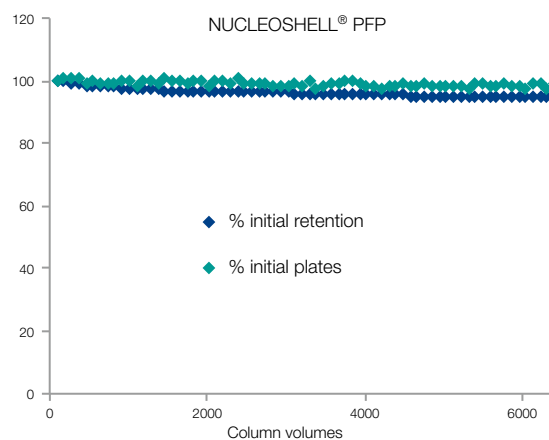

β-Blockers · orthogonal selectivity of NUCLEOSHELL® PFP

MN Appl. No. 125610

Columns: 100 x 4.6 mm
NUCLEOSHELL® RP 18, 2.7 μm
NUCLEOSHELL® PFP, 2.7 μm
Eluent: A) acetonitrile + 0.1 % formic acid
B) 0.1 % formic acid
10–35 % A in 2.5 min, 35–50 % A in 2 min
Flow rate: 1.7 mL/min
Temperature: 25 °C
Detection: UV, 280 nm

Peaks:

- | | |
|----------------|----------------|
| 1. Atenolol | 4. Labetalol |
| 2. Pindolol | 5. Alprenolol |
| 3. Metroprolol | 6. Propranolol |

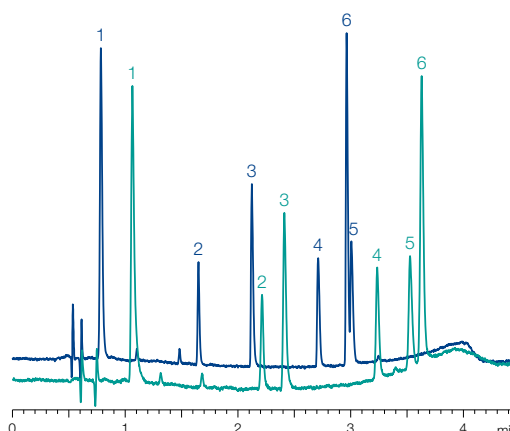



Methylacetophenones

MN Appl. No. 125590

Columns: 100 x 4.6 mm NUCLEOSHELL® PFP, 2.7 µm
 250 x 4 mm NUCLEODUR® PFP, 5 µm
 100 x 4.6 mm Kinetex® 2.6 µm F5
 Eluent: Methanol – water (35:65, v/v)
 Flow rate: 1.5 mL/min, 3 mL/min, 1 mL/min, 1.5 mL/min
 Temperature: 35 °C
 Detection: UV, 254 nm

Peaks:
 1. *o*-Methylacetophenone
 2. *p*-Methylacetophenone
 3. *m*-Methylacetophenone

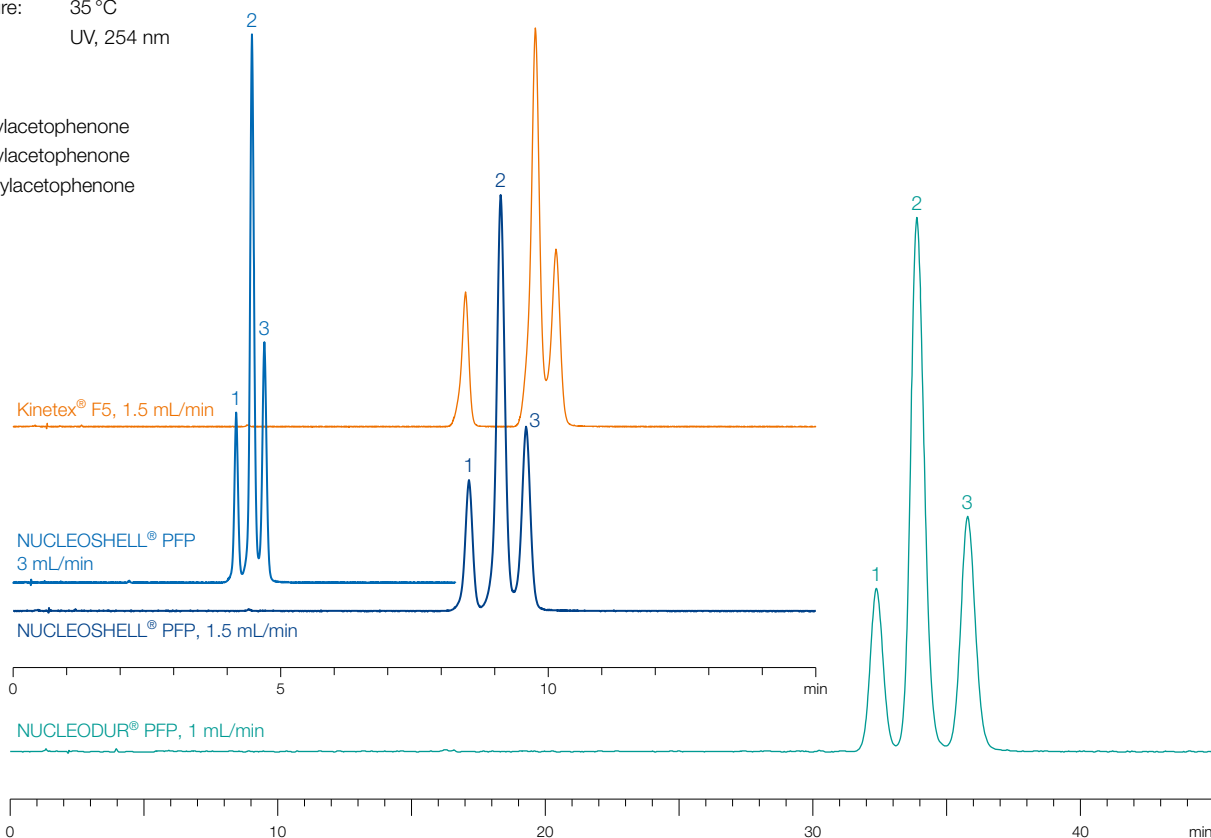

NUCLEOSHELL® PFP combines the benefits of core-shell technology, high stability, and orthogonal selectivity. Thus it is a useful complementary tool for highly efficient separations especially of isomers, halogenated, aromatic and/or polar compounds.

Eluent in column acetonitrile – water

ID	Length → 50 mm	100 mm		150 mm		EC guard columns*
NUCLEOSHELL® PFP, 2.7 µm; particle size 2.7 µm						
Analytical EC columns						
	2 mm	763532.20	763534.20	763536.20	763538.20	763538.20
	3 mm	763532.30	763534.30	763536.30	763538.30	763538.30
	4 mm	763532.40	763534.40	763536.40	763538.30	763538.30
	4.6 mm	763532.46	763534.46	763536.46	763538.30	763538.30

EC columns in packs of 1, guard columns in packs of 3.

Guard column system

Guard columns for EC columns with ID	2 mm	3 mm	4 mm	4.6 mm	Guard column holder
* Column Protection System (pack of)	EC 4/2 (3)	4/3 (3)	4/3 (3)	4/3 (3)	718966

For details of the EC column system please see page 258.

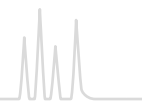

NUCLEOSHELL® HILIC zwitterionic phase

★ Key feature

- Core-shell technology for fast and efficient HPLC
- Ideal for reproducible and stable chromatography of highly polar analytes
- Very short column equilibration times

🔧 Technical data

- Ammonium – sulfonic acid modified silica; pore size 90 Å, particle size 2.7 µm; carbon content 1.3 %; pH stability 2 – 8.5; suitable for LC/MS

✓ Recommended application

- Hydrophilic compounds such as polar organic acids and bases, polar natural compounds, nucleosides, oligonucleotides, amino acids, peptides, water-soluble vitamins

Hydrophilic interaction chromatography

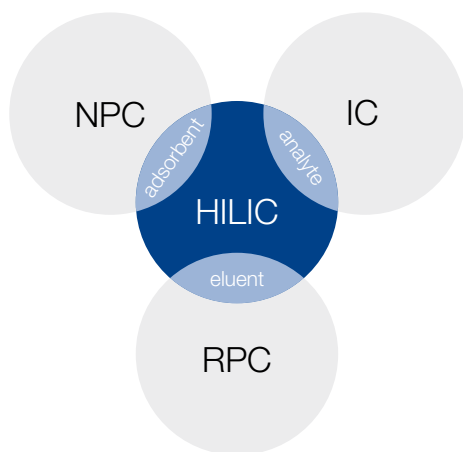

Hydrophilic interaction chromatography (HILIC) is a separation technique using polar stationary phases and organic-aqueous mobile phases. A minimum water content of at least 2 % is indispensable to provide a permanent water layer between the adsorbent surface and the organic fraction of the mobile phase. The sample molecules become separated in a partition chromatography, in which polar analytes are more strongly retained than neutral, less hydrophilic compounds. Consequently, increasing the aqueous part in the mobile phase will diminish retention of the polar sample constituents. In this way HILIC behaves inverse to classical RP chromatography. The particular retention profile of HILIC enables the chromatography of very polar and often small molecules, which won't show any retention on C₈ or C₁₈ reversed phases.

Ultra-fast separations at moderate back pressure

NUCLEOSHELL® HILIC is a core-shell technology based stationary phase with a covalently bonded 3-*N,N*-dimethylamino-propane sulfonic acid ligand (pat. p. nd.). The betaine character of the strong ion-exchanger results in full charge balancing and facilitates fast equilibration times.

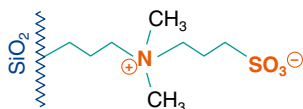

Good separation of polar compounds like the physiologically important substances creatine and creatinine can be achieved on NUCLEOSHELL® HILIC as well as on NUCLEODUR® HILIC, 1.8 µm at similar retention, but much lower back pressure.

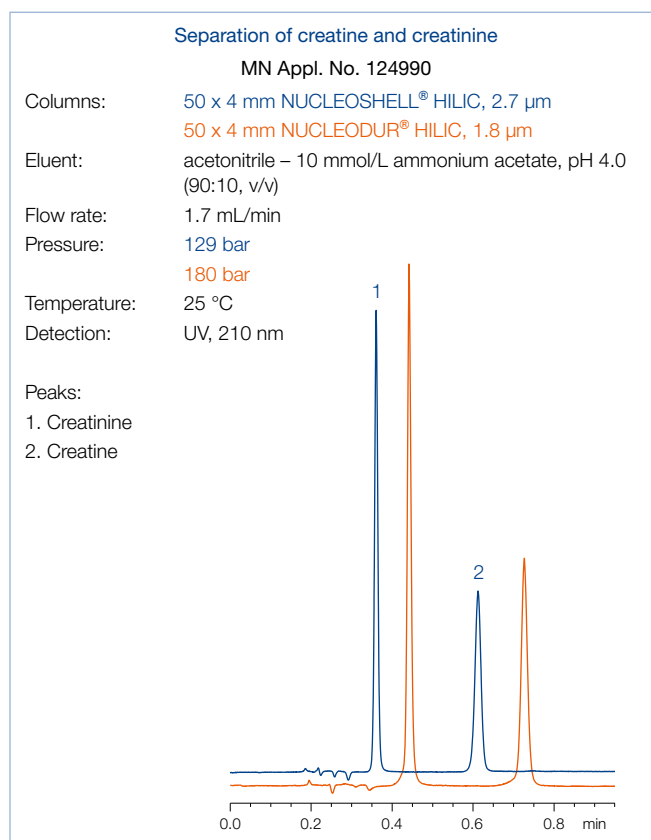

The following chromatograms show the method transfer from a fully porous 3 µm HILIC phase to 2.7 µm core-shell silica with equal selectivity features.

Run time has been cut down to 1 min. Column back pressure remains modest < 400 bar, while solvent demand is reduced to less than 35 %.



Separation of catecholamines

MN Appl. No. 125440

Columns: 100 x 4 mm NUCLEOSHELL® HILIC, 2.7 µm
 100 x 4 mm NUCLEOSHELL® HILIC, 2.7 µm
 250 x 4 mm NUCLEODUR® HILIC, 3 µm

Eluent: acetonitrile – 100 mmol/L ammonium formate, pH 3.2 (80:20, v/v)

Flow rate: 4 mL/min, 1 mL/min, 1 mL/min

Pressure: 395 bar, 95 bar, 116 bar

Temperature: 25 °C

Detection: UV, 280 nm

Peaks:

- 1. DOPAC
- 2. Serotonin
- 3. Dopamine
- 4. Epinephrine
- 5. Norepinephrine
- 6. DOPA
- 7. DOPS

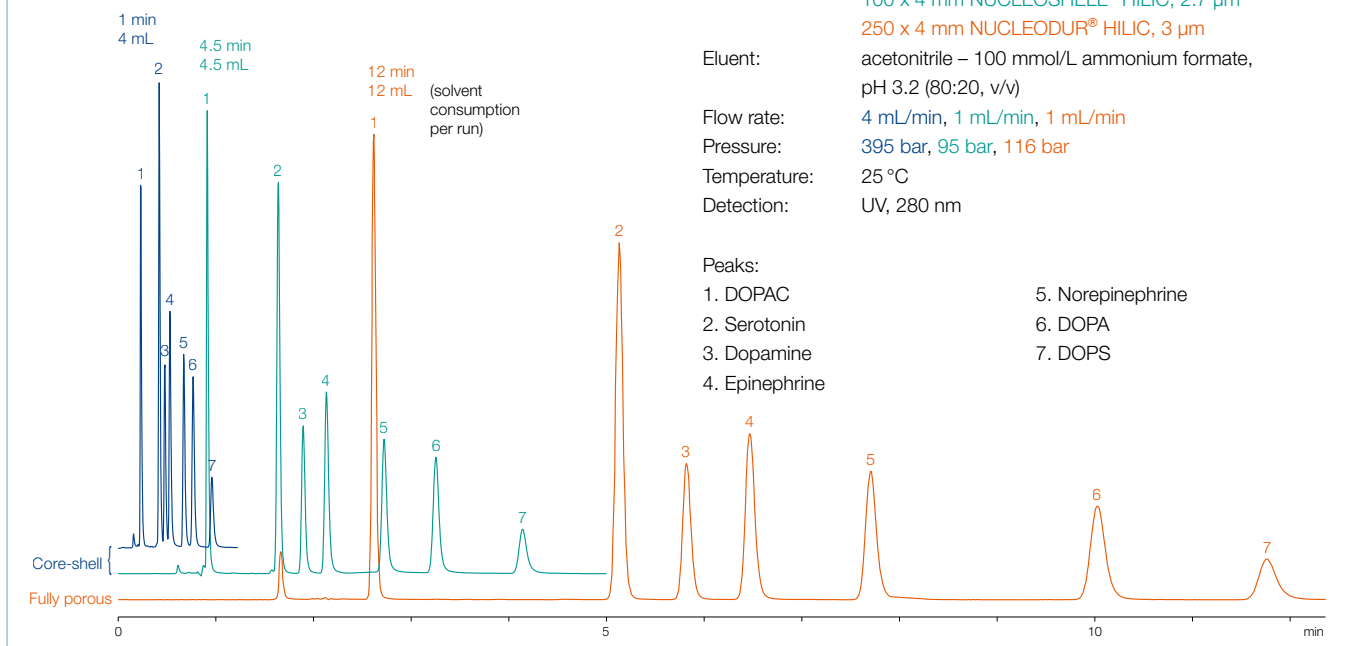

Core-shell silica: separation in 1 min pressure < 400 bar

NUCLEOSHELL® HILIC provides stable and reproducible chromatography, comprising all the benefits of a state-of-the-art core-shell silica.

Eluent in column acetonitrile – water

ID	Length → 50 mm	100 mm			150 mm		EC guard columns*
		100 mm	100 mm	100 mm	150 mm	150 mm	
NUCLEOSHELL® HILIC, 2.7 µm; particle size 2.7 µm							
Analytical EC columns							
	2 mm	763332.20	763334.20	763336.20	763338.20	763338.20	
	3 mm	763332.30	763334.30	763336.30	763338.30	763338.30	
	4 mm	763332.40	763334.40	763336.40	763338.30	763338.30	
	4.6 mm	763332.46	763334.46	763336.46	763338.30	763338.30	
EC columns in packs of 1, guard columns in packs of 3.							

Guard column system

Guard columns for EC columns with ID	2 mm	3 mm	4 mm	4.6 mm	Guard column holder
* Column Protection System (pack of)	EC 4/2 (3)	4/3 (3)	4/3 (3)	4/3 (3)	718966

For details of the EC column system please see page 258.

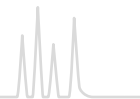

MACHEREY-NAGEL

Column Protection System

The guard column system for HPLC / UHPLC from MN

- Ideal protection for your analytical main column:
significant increase in column lifetime
 - Minimized void volume:
suitable also for ultra fast HPLC (UHPLC)
 - Special ferrules:
pressure stability up to 1300 bar (18850 psi)
 - Cartridges filled with NUCLEODUR[®], NUCLEOSIL[®] and
NUCLEOSHELL[®] HPLC adsorbents.
 - Universal screw-on guard column holder system
 - Suitable for all analytical HPLC columns with 1/16" fittings
- Further information on page 258.





NUCLEOSIL[®]

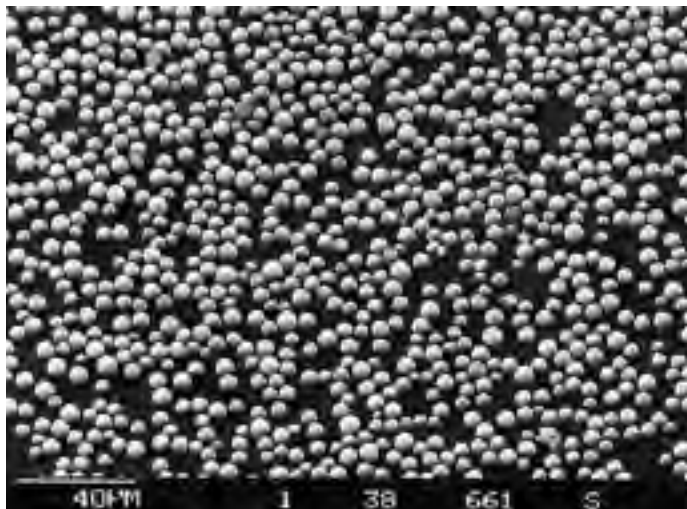

★ Key feature

- NUCLEOSIL[®] is a family of totally porous spherical silicas. They feature a very pure and uniform SiO₂ structure and have gained wide acceptance as routine chromatographic packings for very different fields of modern chromatography.
- One of the first spherical silicas used in HPLC
- Developed in the early seventies, it became a world-renowned HPLC packing
- Absolutely reliable choice for routine analyses
- Largest variety of modified HPLC silicas available
- pH stability 2–8 (for NUCLEOSIL[®] 100-5 C₁₈ AB 1-9)
- Due to its particle sizes NUCLEOSIL[®] finds application in analytical as well as in preparative columns.

Benefits of NUCLEOSIL[®] silica

- High efficiency due to narrow particle size distribution
- High separation performance due to optimized binding techniques
- High chemical and mechanical stability
- High load capacity and recovery rates
- High reproducibility from lot to lot

Physical properties

NUCLEOSIL[®] is manufactured with different pore diameters (50, 100, 120, 300, 500, 1000 and 4000 Å) and particle sizes from 3 μm (only NUCLEOSIL[®] 50, 100 and 120) to 10 μm with very narrow fractionation. All narrow-pore NUCLEOSIL[®] packings are stable up to 500 bar (7,250 psi), the wide-pore NUCLEOSIL[®] silicas are stable up to 300 or 400 bar (4,200 or 5,600 psi).

Physical properties of unmodified NUCLEOSIL[®] materials

Phase	Pore size	Pore volume	Surface (BET)	Density	Pressure stability*
NUCLEOSIL [®] 50	50 Å	0.8 mL/g	420 m ² /g	0.45 g/mL	500 bar
NUCLEOSIL [®] 100	100 Å	1 mL/g	350 m ² /g	0.36 g/mL	500 bar
NUCLEOSIL [®] 120	120 Å	0.65 mL/g	200 m ² /g	0.55 g/mL	500 bar
NUCLEOSIL [®] 300	300 Å	0.8 mL/g	100 m ² /g	0.45 g/mL	400 bar
NUCLEOSIL [®] 500	500 Å	0.8 mL/g	35 m ² /g	0.45 g/mL	400 bar
NUCLEOSIL [®] 1000	1000 Å	0.8 mL/g	25 m ² /g	0.45 g/mL	300 bar
NUCLEOSIL [®] 4000	4000 Å	0.7 mL/g	10 m ² /g	0.48 g/mL	300 bar

* Maximum packing pressure of NUCLEOSIL[®] bulk packings

NUCLEOSIL[®] modifications

- NUCLEOSIL[®] packings are available as unmodified silica or with numerous chemically bonded phases: RP phases like C₁₈ AB, C₁₈ HD, C₁₈ Nautilus, C₁₈, C₁₈ ec, Protect I, C₈ HD, C₈ ec, C₈, C₄, C₂ and C₆H₅ separate mainly by hydrophobic interactions (van der Waals forces). The less polar the sample molecules, the more they are retained – the more polar the sample, the weaker are the hydrophobic interactions and consequently the retention times are shorter.
- Phases with chemically bonded polar groups such as CN, NH₂, N(CH₃)₂, OH show selective separation properties. Due to the availability of different functional groups it is pos-

sible to vary the chemical characteristics of the surface and consequently the adsorption characteristics of the stationary phase.

- Silica-based ion exchangers (NUCLEOSIL[®] SA and SB) are stable from pH 2 to 8 and do not swell. Compared to resin-based ion exchangers they offer the advantage of constant permeability, even when the ionic strength and/or pH of the eluent are changed. The separation can be influenced by
 - the type of buffer
 - the ionic strength and
 - the pH value.







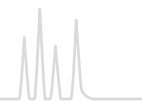



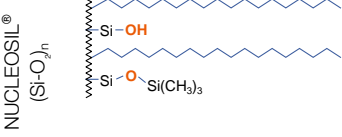

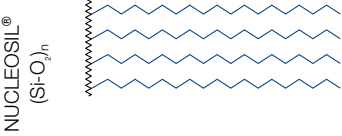

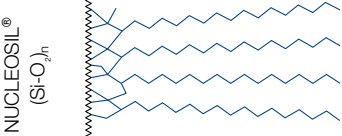

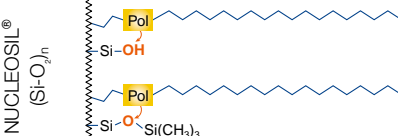
A tabular overview of NUCLEOSIL[®] phases can be found on page 218.

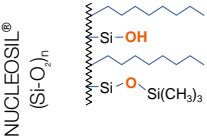

NUCLEOSIL[®] phase overview

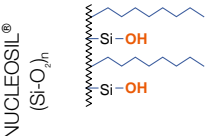

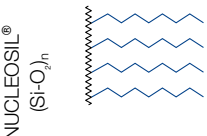

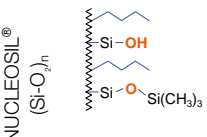





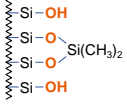





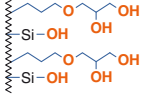

Overview of NUCLEOSIL[®] HPLC phases

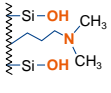
Phase	Specification	Page	Stability	Interactions	Structure
NUCLEOSIL[®] RP-Phasen					
 C ₁₈	octadecyl phase, medium density modification, endcapping 15 % C · USP L1	220	pH 2–8	hydrophobic (van der Waals) interactions slight residual silanol interactions	 NUCLEOSIL [®] (Si-O) _{2n}
 C ₁₈ HD	octadecyl phase, high density monomeric modification, endcapping 20 % C · USP L1	220	pH 2–9	hydrophobic (van der Waals) interactions	 NUCLEOSIL [®] (Si-O) _{2n}
 C ₁₈ AB	octadecyl phase, special crosslinked modification, endcapping 25 % C · USP L1	220	pH 1–9	steric and hydrophobic interactions	 NUCLEOSIL [®] (Si-O) _{2n}
 C ₁₈ Nautilus	octadecyl phase, embedded polar group, endcapping 16 % C · USP L60	220	pH 2–8 up to 100 % H ₂ O	hydrophobic and polar interactions	 NUCLEOSIL [®] (Si-O) _{2n}
 Protect I	special RP phase, protective polar group, monomeric modification, endcapping 11 % C	222	pH 2–8 up to 100 % H ₂ O	hydrophobic and polar interactions	 NUCLEOSIL [®] (Si-O) _{2n}
 C ₈ ec	octyl phase, medium density modification, endcapping 9 % C · USP L7	224	pH 2–8	hydrophobic (van der Waals) interactions slight residual silanol interactions	 NUCLEOSIL [®] (Si-O) _{2n}
 C ₈	octyl phase, no endcapping 8.5 % C · USP L7	224	pH 2–8	hydrophobic (van der Waals) interactions interactions noticeable residual silanol interactions	 NUCLEOSIL [®] (Si-O) _{2n}
 C ₈ HD	octyl phase, high density modification, endcapping 13 % C · USP L7	224	pH 2–8	hydrophobic (van der Waals) interactions	 NUCLEOSIL [®] (Si-O) _{2n}
 C ₄	butyl phase, medium density modification, endcapping ~ 2 % C · USP L26	225	pH 2–8	hydrophobic (van der Waals) interactions residual silanol interactions	 NUCLEOSIL [®] (Si-O) _{2n}

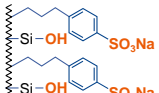

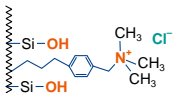
Overview of NUCLEOSIL® HPLC phases

Phase	Specification	Page	Stability	Interactions	Structure
 C ₂	dimethyl phase 3.5% C · USP L16	225	pH 2–8	hydrophobic (van der Waals) interactions noticeable residual silanol interactions	NUCLEOSIL® (Si-O) _{2,n} 
 C ₆ H ₅	phenyl phase, no endcapping 8% C · USP L11	226	pH 2–8	π-π interactions and hydrophobic interactions noticeable residual silanol interactions	NUCLEOSIL® (Si-O) _{2,n} 
Polar NUCLEOSIL® phases and NUCLEOSIL® ion exchangers					
 CN / CN-RP	cyano (nitrile) phase USP L10	228	pH 2–8	π-π, polar and hydrophobic interactions	NUCLEOSIL® (Si-O) _{2,n} 
 OH (Diol)	diol · USP L20	226	pH 2–8	polar interactions (hydrogen bonds)	NUCLEOSIL® (Si-O) _{2,n} 
 NH ₂ / NH ₂ -RP	amino · USP L8	227	pH 2–8	polar and hydrophobic interactions, weak ion exchange interactions	NUCLEOSIL® (Si-O) _{2,n} 
 N(CH ₃) ₂	dimethylamino	225	pH 2–8	polar and hydrophobic interactions, weak ion exchange interactions	NUCLEOSIL® (Si-O) _{2,n} 
 SA	sulfonic acid, strongly acid cation exchanger (SCX) USP L9	229	pH 2–8	strong ion exchange interactions	NUCLEOSIL® (Si-O) _{2,n} 
 SB	quaternary ammonium, strongly basic anion exchanger (SAX) USP L14	229	pH 2–8	strong ion exchange interactions	NUCLEOSIL® (Si-O) _{2,n} 
 SiOH	unmodified spherical silica USP L3	230	pH 2–8	polar	NUCLEOSIL® (Si-O) _{2,n} 

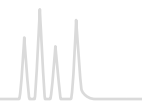

NUCLEOSIL[®] octadecyl phases (C₁₈)

NUCLEOSIL[®] standard octadecyl phases · USP L1

- (CH₂)₁₇–CH₃
- Technical data
 - Nonpolar phases
 - pH stability at 20 °C: 2 – 8
 - carbon content depending on pore size (see table)
 - Corresponding NUCLEODUR[®] phases see C₁₈ ec page 181

NUCLEOSIL[®] C₁₈ HD · USP L1

- (CH₂)₁₇–CH₃
- Technical data
 - Nonpolar hydrophobic high density phases; monomeric modification
 - pH stability 2 – 9
 - Carbon content 20 %
 - Corresponding NUCLEODUR[®] phases see C₁₈ Gravity page 158

NUCLEOSIL[®] C₁₈ AB · USP L1

- (CH₂)₁₇–CH₃
- Technical data
 - Crosslinked hydrophobic phase; polymeric modification; inert towards acidic and basic substances with high affinity for silica
 - pH stability 1 – 9
 - Carbon content 25 %; distinct steric selectivity
 - Corresponding NUCLEODUR[®] phases see C₁₈ Isis page 164

NUCLEOSIL[®] C₁₈ Nautilus · USP L60

- (CH₂)₁₇–CH₃
- Technical data
 - Stable in 100 % aqueous eluents
 - Carbon content 16 %
 - Interesting polar selectivity features; very good base deactivation
 - Corresponding NUCLEODUR[®] phases see PolarTec page 168







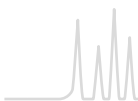



All NUCLEOSIL[®] octadecyl phases are endcapped.
 Custom-packed columns with different column dimensions are available on request.

Eluent in column acetonitrile – water

ID	Length →				EC guard columns*
	100 mm	125 mm	150 mm	250 mm	
NUCLEOSIL [®] 50-5 C ₁₈ ec; particle size 5 µm, pore size 50 Å, endcapped, 14.5 % C					
Analytical EC columns					
	4.6 mm			720098.46	721473.30
NUCLEOSIL [®] 100-3 C ₁₈ ; particle size 3 µm, pore size 100 Å, endcapped, 15 % C					
Analytical EC columns					
	4 mm		720150.40	720133.40	721022.30
	4.6 mm	720841.46	720150.46	720949.46	720133.46
NUCLEOSIL [®] 100-5 C ₁₈ ; particle size 5 µm, pore size 100 Å, endcapped, 15 % C					
Analytical EC columns					
	2 mm		720002.20	720014.20	721074.20
	3 mm		720002.30	720014.30	721074.30
	4 mm	720141.40	720002.40	720120.40	720014.40
	4.6 mm	720141.46	720002.46	720120.46	720014.46



Eluent in column acetonitrile – water

ID	Length → 100 mm	125 mm			150 mm			250 mm			EC guard columns*
NUCLEOSIL® 100-7 C₁₈ ; particle size 7 µm, pore size 100 Å, endcapped, 15 % C											
Analytical EC columns											
	4 mm										720018.40
	4.6 mm		720951.46		720110.46						720018.46
NUCLEOSIL® 100-10 C₁₈ ; particle size 10 µm, pore size 100 Å, endcapped, 15 % C											
Analytical EC columns											
	4 mm										720023.40
	4.6 mm		720701.46		720140.46						720023.46
NUCLEOSIL® 120-3 C₁₈ ; particle size 3 µm, pore size 120 Å, endcapped, 11 % C											
Analytical EC columns											
	4 mm	720149.40		720040.40						720055.40	721075.30
	4.6 mm	720149.46		720040.46		720740.46			720055.46		721075.30
NUCLEOSIL® 120-5 C₁₈ ; particle size 5 µm, pore size 120 Å, endcapped, 11 % C											
Analytical EC columns											
	4 mm			720051.40					720041.40		721070.30
	4.6 mm			720051.46		720730.46			720041.46		721070.30
NUCLEOSIL® 120-7 C₁₈ ; particle size 7 µm, pore size 120 Å, endcapped, 11 % C											
Analytical EC columns											
	4 mm										720042.40
	4.6 mm										
NUCLEOSIL® 120-10 C₁₈ ; particle size 10 µm, pore size 120 Å, endcapped, 11 % C											
Analytical EC columns											
	4 mm										720043.40
	4.6 mm										720043.46
NUCLEOSIL® 100-3 C₁₈ HD ; particle size 3 µm, pore size 100 Å, 20 % C											
Analytical EC columns											
	4 mm			720191.40							721196.30
	4.6 mm			720191.46		720193.46					721196.30
NUCLEOSIL® 100-5 C₁₈ HD ; particle size 5 µm, pore size 100 Å, 20 % C											
Analytical EC columns											
	4 mm			720296.40					720280.40		721072.30
	4.6 mm			720296.46		720294.46			720280.46		721072.30
NUCLEOSIL® 100-5 C₁₈ AB ; particle size 5 µm, pore size 100 Å, 25 % C											
Analytical EC columns											
	4 mm			720935.40					720936.40		721073.30
	4.6 mm			720935.46		720305.46			720936.46		721073.30
NUCLEOSIL® 100-3 C₁₈ Nautilus ; particle size 3 µm, pore size 100 Å, 16 % C											
Analytical EC columns											
	4 mm			720472.40							721649.30
	4.6 mm			720472.46		720471.46					721649.30
NUCLEOSIL® 100-5 C₁₈ Nautilus ; particle size 5 µm, pore size 100 Å, 16 % C											
Analytical EC columns											
	4 mm			720430.40					720431.40		721133.30
	4.6 mm			720430.46		720432.46			720431.46		721133.30

Guard column system

Guard columns for EC columns with ID		2 mm	3 mm	4 mm	4.6 mm	Guard column holder
* Column Protection System (pack of)	EC	4/2 (3)	4/3 (3)	4/3 (3)	4/3 (3)	718966

EC columns in packs of 1, guard columns in packs of 3. For details of our column systems see page 258.

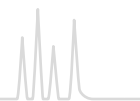

NUCLEOSIL[®] octadecyl phases (C₁₈) wide pore octadecyl phases · USP L1

Technical data

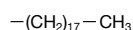

- Many biologically interesting molecules can not be separated using conventional narrow pore silicas with pore sizes of about 100 Å. This is why MACHEREY-NAGEL offers a complete line of wide pore packings with pore sizes of 300, 500, 1000 and 4000 Å.
- These materials can also be used for size exclusion chromatography (SEC).

All NUCLEOSIL[®] octadecyl phases are endcapped.
Custom-packed columns with different column dimensions are available on request.

Eluent in column acetonitrile – water

ID	Length →		EC guard columns*
	125 mm	250 mm	
NUCLEOSIL[®] 300-5 C₁₈; particle size 5 µm, pore size 300 Å, endcapped, 6.5 % C			
Analytical EC columns			
	4 mm	720065.40	721085.30
	4.6 mm	720065.46	721085.30
NUCLEOSIL[®] 500-7 C₁₈; particle size 7 µm, pore size 500 Å, endcapped, 2 % C			
Analytical EC columns			
	4.6 mm	720074.46	
NUCLEOSIL[®] 1000-7 C₁₈; particle size 7 µm, pore size 1000 Å, endcapped, ~ 1 % C			
Analytical EC columns			
	4.6 mm	720077.46	

EC columns in packs of 1, guard columns in packs of 3.

VarioPrep preparative HPLC columns with NUCLEOSIL[®] packing material on request.

NUCLEOSIL[®] 100 Protect I special RP phase with protective polar group

Technical data

- RP phase with pronounced hydrophilic properties
- Monomeric coating
- Endcapped
- Carbon content 11 %

Eluent in column acetonitrile – water

ID	Length →			EC guard columns*
	125 mm	150 mm	250 mm	
NUCLEOSIL[®] 100-5 Protect I; particle size 5 µm, pore size 100 Å				
Analytical EC columns				
	4 mm	720175.40	720170.40	721157.30
	4.6 mm	720175.46	720174.46	720170.46

Guard column system

Guard columns for EC columns with ID	2 mm	3 mm	4 mm	4.6 mm	Guard column holder
* Column Protection System (pack of)	EC 4/2 (3)	4/3 (3)	4/3 (3)	4/3 (3)	718966

EC columns in packs of 1, guard columns in packs of 3. For details of our column systems see page 258.

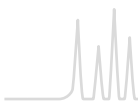

NUCLEOSIL[®] octyl phases (C₈) NUCLEOSIL[®] standard octyl phases · USP L7

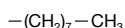











🔧 Technical data

- Nonpolar phases for RP and ion-pairing chromatography
- Endcapped and non-endcapped modifications available; pH stability at 20 °C: 2–8
- Carbon content depending on pore size (see table)

✅ Recommended application

- Separation of moderately to highly polar (water-soluble) compounds: steroids, nucleosides, cyclodextrins, pharmacological plant constituents
- Corresponding NUCLEODUR[®] phases see C₈ ec page 183

Eluent in column acetonitrile – water

ID	Length →			EC guard columns*
	125 mm	150 mm	250 mm	
NUCLEOSIL[®] 100-5 C₈ ec; particle size 5 μm, pore size 100 Å, endcapped, 9 % C				
Analytical EC columns				
 4.6 mm			720165.46	721096.30
NUCLEOSIL[®] 100-5 C₈; particle size 5 μm, pore size 100 Å, not endcapped, 8.5 % C				
Analytical EC columns				
 4 mm	720001.40		720013.40	721194.30
 4.6 mm	720001.46	720990.46	720013.46	721194.30
NUCLEOSIL[®] 100-7 C₈; particle size 7 μm, pore size 100 Å, not endcapped, 8.5 % C				
Analytical EC columns				
 4.6 mm			720017.46	
NUCLEOSIL[®] 100-10 C₈; particle size 10 μm, pore size 100 Å, not endcapped, 8.5 % C				
Analytical EC columns				
 4 mm			720022.40	
 4.6 mm			720022.46	
NUCLEOSIL[®] 120-3 C₈; particle size 3 μm, pore size 120 Å, not endcapped, 6.5 % C				
Analytical EC columns				
 4 mm	720071.40			721093.30
 4.6 mm	720071.46	720214.46		721093.30
NUCLEOSIL[®] 120-5 C₈; particle size 5 μm, pore size 120 Å, not endcapped, 6.5 % C				
Analytical EC columns				
 4 mm	720050.40		720052.40	721095.30
 4.6 mm	720050.46	720735.46	720052.46	721095.30
NUCLEOSIL[®] 300-5 C₈; particle size 5 μm, pore size 300 Å, not endcapped, ~ 3 % C				
Analytical EC columns				
 4.6 mm			720062.46	721061.30

Custom-packed columns with different column dimensions are available on request.

Guard column system

Guard columns for EC columns with ID		2 mm	3 mm	4 mm	4.6 mm	Guard column holder
* Column Protection System (pack of)	EC	4/2 (3)	4/3 (3)	4/3 (3)	4/3 (3)	718966

EC columns in packs of 1, guard columns in packs of 3. For details of our column systems see page 258.

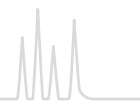

NUCLEOSIL[®] octyl phases (C₈) NUCLEOSIL[®] C₈ HD · USP L7

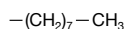

Technical data

- Nonpolar high density phases; monomeric modification; endcapped; carbon content 13 %
- Corresponding NUCLEODUR[®] phases see C₈ Gravity page 158

Recommended application

- Separation of moderate to strong polar (water soluble) analytes like steroids, cyclodextrines, pharmaceutical plant ingredients

Eluent in column acetonitrile – water

ID	Length →			EC guard columns*
	125 mm	150 mm	250 mm	
NUCLEOSIL [®] 100-5 C ₈ HD; particle size 5 μm, pore size 100 Å				
Analytical EC columns				
	4 mm		720196.40	721071.30
	4.6 mm	720194.46	720196.46	721071.30
Custom-packed columns with different column dimensions are available on request.				

Guard column system

Guard columns for EC columns with ID	2 mm	3 mm	4 mm	4.6 mm	Guard column holder
* Column Protection System (pack of)	EC 4/2 (3)	4/3 (3)	4/3 (3)	4/3 (3)	718966

EC columns in packs of 1, guard columns in packs of 3. For details of our column systems see page 258.



Beside analytical HPLC columns we also produce VarioPrep columns (see page 260) for preparative applications.



NUCLEOSIL[®] butyl phases (C₄) · USP L26

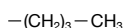

Technical data

- Endcapped phases for RP and ion-pairing chromatography
- pH stability at 20 °C: 2–8; carbon content ~ 2 %
- Retention times are shorter than on C₈ and C₁₈ phases

Recommended application

- For separation of macromolecules and hydrophobic substances
- For butyl phases for biochemical separations please refer to page 244

Eluent in column acetonitrile – water

ID	Length → 250 mm	EC guard columns*
NUCLEOSIL [®] 120-5 C ₄ ; particle size 5 μm, pore size 120 Å		
Analytical EC columns		
4.6 mm	720096.46	721083.30
NUCLEOSIL [®] 300-5 C ₄ ; particle size 5 μm, pore size 300 Å		
Analytical EC columns		
4 mm	720059.40	721916.30
4.6 mm	720059.46	721916.30

Guard column system

Guard columns for EC columns with ID	2 mm	3 mm	4 mm	4.6 mm	Guard column holder
* Column Protection System (pack of)	EC 4/2 (3)	4/3 (3)	4/3 (3)	4/3 (3)	718966

NUCLEOSIL[®] dimethyl phase (C₂) · USP L16



Technical data

- Non-endcapped phase for RP and ion-pairing chromatography
- pH stability at 20 °C: 2–8; carbon content 3.5 %

- Retention times are much shorter than for the other RP phases

Eluent in column acetonitrile – water

ID	Length → 250 mm	EC guard columns*
NUCLEOSIL [®] 100-7 C ₂ ; particle size 7 μm, pore size 100 Å		
Analytical EC columns		
4.6 mm	720089.46	721030.30

EC columns in packs of 1, guard columns in packs of 3. For details of our column systems see page 258.

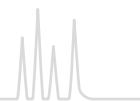

NUCLEOSIL[®] phenyl phases (C₆H₅) · USP L11

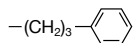

Technical data

- Relatively nonpolar, non-encapped phases for RP and ion pairing chromatography
- Polarity similar to C₈, but with different selectivity for PAHs, polar aromatics, fatty acids etc.
- pH stability at 20 °C: 2–8; carbon content 8%

Recommended application

- Separation of moderately polar compounds

Eluent in column acetonitrile – water

ID	Length → 250 mm	EC guard columns*
NUCLEOSIL [®] 100-5 C ₆ H ₅ ; particle size 5 μm, pore size 100 Å, not encapped		
Analytical EC columns		
4.6 mm	720956.46	721137.30
NUCLEOSIL [®] 100-7 C ₆ H ₅ ; particle size 7 μm, pore size 100 Å, not encapped		
Analytical EC columns		
4 mm	720019.40	
4.6 mm	720019.46	

NUCLEOSIL[®] diol phases · USP L20

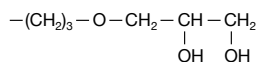

Technical data

- Dihydroxypropyl modified silica for RP and NP chromatography
- Less polar than unmodified silica, very easily wettable with water

- pH stability at 20 °C: 2–8; carbon content 5%

Eluent in column is *n*-heptane. When using an eluent which is not miscible with *n*-heptane (e.g., water), it is necessary to rinse the column with THF first.

ID	Length → 250 mm	EC guard columns*
NUCLEOSIL [®] 100-5 OH (Diol); particle size 5 μm, pore size 100 Å		
Analytical EC columns		
4.6 mm	720143.46	721142.30

Guard column system

Guard columns for EC columns with ID	2 mm	3 mm	4 mm	4.6 mm	Guard column holder
* Column Protection System (pack of)	EC 4/2 (3)	4/3 (3)	4/3 (3)	4/3 (3)	718966

EC columns in packs of 1, guard columns in packs of 3. For details of our column systems see page 258.



NUCLEOSIL® amino phases · USP L8

🔧 Technical data

- Aminopropyl modified polar silica phase; pH stability at 20 °C: 2–8; carbon content 3.5 %
- Corresponding NUCLEODUR® phases see page 188

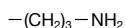



✅ Recommended application

Multi-mode chromatography

- NP chromatography with hexane, dichloromethane or 2-propanol as mobile phase for polar compounds such as substituted anilines, esters, chlorinated pesticides
- RP chromatography of polar compounds like carbohydrates in aqueous-organic eluent systems
- Anion exchange chromatography of anions and organic acids using common buffers (e. g., acetate or phosphate) in conjunction with organic modifiers (e. g., acetonitrile)

Eluent in column is *n*-heptane (except for NH₂ RP). When using an eluent which is not miscible with *n*-heptane (e.g., water), it is necessary to rinse the column with THF first.

ID	Length → 250 mm	EC guard columns*
NUCLEOSIL® 100-5 NH ₂ ; particle size 5 µm, pore size 100 Å; eluent in column <i>n</i> -heptane		
Analytical EC columns		
 4.6 mm	720095.46	721020.30
NUCLEOSIL® 100-5 NH ₂ -RP; particle size 5 µm, pore size 100 Å; eluent in column acetonitrile – water (80:20)		
Analytical EC columns		
 4.6 mm	720095.46RP	721155.30
NUCLEOSIL® 100-10 NH ₂ ; particle size 10 µm, pore size 100 Å; eluent in column <i>n</i> -heptane		
Analytical EC columns		
 4.6 mm	720025.46	

NUCLEOSIL® dimethylamino phase

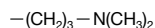

🔧 Technical data

- Weakly basic anion exchanger, pH stability at 20 °C: 2–8; carbon content 4 %

✅ Recommended application

- Separation of many anions; can also be used in a similar way as the NH₂ phase

Eluent in column is *n*-heptane. When using an eluent which is not miscible with *n*-heptane (e.g., water), it is necessary to rinse the column with THF first.

ID	Length → 250 mm	EC guard columns*
NUCLEOSIL® 100-5 N(CH ₃) ₂ ; particle size 5 µm, pore size 100 Å		
Analytical EC columns		
 4.6 mm	720994.46	721158.30

Guard column system

Guard columns for EC columns with ID	2 mm	3 mm	4 mm	4.6 mm	Guard column holder
* Column Protection System (pack of)	EC 4/2 (3)	4/3 (3)	4/3 (3)	4/3 (3)	718966

EC columns in packs of 1, guard columns in packs of 3. For details of our column systems see page 258.

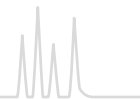

NUCLEOSIL[®] cyano phases · USP L10

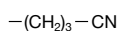

Technical data

- Polar to midpolar cyano (nitrile) modified silica
- pH stability at 20 °C: 2–8; carbon content 5 % for 100 Å pores, ~ 3 % for 120 Å pores
- Corresponding NUCLEODUR[®] phases see page 186

Recommended application

Reversed phase and normal phase chromatography

- Normal phase: with low-polarity solvents for many compounds, which can also be separated on unmodified silica, however, due to the rapid equilibration much more suitable for gradient separations
- Reversed phase: with different selectivity than C₁₈, C₈ or phenyl modified packings

Eluent in column (except for NUCLEOSIL[®] 100-5 CN-RP) is *n*-heptane. When using an eluent which is not miscible with *n*-heptane (e.g., water), it is necessary to rinse the column with THF first.

ID	Length →250 mm	EC guard columns*
NUCLEOSIL[®] 100-5 CN; particle size 5 µm, pore size 100 Å; eluent in column <i>n</i>-heptane		
Analytical EC columns		
4 mm	720090.40	721078.30
4.6 mm	720090.46	721078.30
NUCLEOSIL[®] 100-5 CN-RP; particle size 5 µm, pore size 100 Å; eluent in column acetonitrile – water		
Analytical EC columns		
4 mm	720205.40	721039.30
4.6 mm	720205.46	721039.30
NUCLEOSIL[®] 100-10 CN; particle size 10 µm, pore size 100 Å; eluent in column <i>n</i>-heptane		
Analytical EC columns		
4 mm	720024.40	
4.6 mm	720024.46	
NUCLEOSIL[®] 120-7 CN; particle size 7 µm, pore size 120 Å; eluent in column <i>n</i>-heptane		
Analytical EC columns		
4 mm	720057.40	
4.6 mm	720057.46	

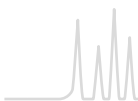

NUCLEOSIL® SA phases · USP L9

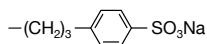

Technical data

- Strongly acidic cation exchanger (SCX) with benzenesulfonic acid modification
- Capacity ~ 1 meq/g; pH stability at 20 °C: 2–8; carbon content 6.5 %

Eluent in column 0.15 mol/L (NH₄)₂HPO₄, pH 5

ID	Length →			EC guard columns*	
	125 mm	150 mm	250 mm		
NUCLEOSIL® 100-5 SA; particle size 5 µm, pore size 100 Å					
Analytical EC columns					
	4 mm			720097.40	721024.30
	4.6 mm	720709.46	720182.46	720097.46	721024.30
NUCLEOSIL® 100-10 SA; particle size 10 µm, pore size 100 Å					
Analytical EC columns					
	4.6 mm			720028.46	

NUCLEOSIL® SB phases · USP L14

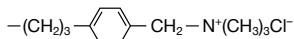

Technical data

- Strongly basic anion exchanger (SAX) with quaternary ammonium modification
- Capacity ~ 1 meq/g; pH stability at 20 °C: 2–8; carbon content 10 %

Eluent in column 0.15 mol/L (NH₄)₂HPO₄, pH 5

ID	Length →			EC guard columns*	
	125 mm	150 mm	250 mm		
NUCLEOSIL® 100-5 SB; particle size 5 µm, pore size 100 Å					
Analytical EC columns					
	4 mm			720996.40	721025.30
	4.6 mm	720989.46	720183.46	720996.46	721025.30
NUCLEOSIL® 100-10 SB; particle size 10 µm, pore size 100 Å					
Analytical EC columns					
	4.6 mm			720029.46	

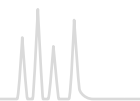



NUCLEOSIL[®] SiOH unmodified silica · USP L3



Technical data

- Spherical silica, pH stability 2–8
- For physical properties of unmodified NUCLEOSIL[®] materials please see page 217.
- Maximum working pressure for the EC columns listed below is 400 bar.

Eluent in column is *n*-heptane. When using an eluent which is not miscible with *n*-heptane (e.g., water), it is necessary to rinse the column with THF first.

ID	Length → 250 mm	EC guard columns*
NUCLEOSIL [®] 50-5; particle size 5 μm, pore size 50 Å		
Analytical EC columns		
 4.6 mm	720093.46	721167.30
NUCLEOSIL [®] 100-5; particle size 5 μm, pore size 100 Å		
Analytical EC columns		
 4.6 mm	720099.46	721518.30

Guard column system

Guard columns for EC columns with ID	2 mm	3 mm	4 mm	4.6 mm	Guard column holder
* Column Protection System (pack of)	EC 4/2 (3)	4/3 (3)	4/3 (3)	4/3 (3)	718966

EC columns in packs of 1, guard columns in packs of 3. For details of our column systems see page 258.



Phase overview for special separations



Overview

Separation / mechanism	Recommended column	Specification of the phase	Page
Environmental analysis			
Anion exchange chromatography of inorganic anions	NUCLEOSIL® Anion I	Strongly basic silica-based anion exchanger	237
RP chromatography of PAHs	NUCLEODUR® C ₁₈ PAH	NUCLEODUR® polymer-coated with C ₁₈ groups USP L1	234
	NUCLEOSIL® 100-5 C ₁₈ PAH	NUCLEOSIL® 100 polymer-coated with C ₁₈ groups USP L1	236
RP chromatography of PFAS	NUCLEODUR® PFAS	Silica-based column for PFAS analysis	232
Enantiomer separation			
Polar and π-π interactions	NUCLEOCEL DELTA	Silica-based modified cellulose phases USP L40	240
Formation of inclusion complexes	NUCLEODEX α-PM, β-PM, γ-PM and β-OH	Silica-based permethylated and underivatized cyclodextrin phases USP L45	238
Enantioselective binding to chiral protein surface structures	RESOLVOSIL BSA-7	Silica-based protein phase (BSA)	241
Ligand exchange	NUCLEOSIL® CHIRAL-1	Covalently bonded amino acid – Cu(II) complexes USP L32	242
Charge-transfer, dipole-dipole interactions and others	NUCLEOSIL® CHIRAL-2	Silica-based brush type phases USP L36	243
	NUCLEOSIL® CHIRAL-3		
Separation of biological macromolecules			
Anion exchange chromatography of oligonucleotides and nucleic acids	NUCLEOGEN® DEAE	Silica-based DEAE anion exchanger	244
Anion exchange chromatography of peptides, large proteins and oligonucleotides	NUCLEOGEL® SAX	Polymer-based strongly basic anion exchanger USP L23	247
Cation exchange chromatography of proteins, peptides and carbohydrates	NUCLEOGEL® SCX	Polymer-based strong cation exchanger USP L22	247
Reversed phase chromatography of proteins, peptides and oligonucleotides	NUCLEOSIL® MPN	Monomerically bonded alkyl chains on silica USP L1 / USP L26	250
	NUCLEOSIL® PPN	Polymerically bonded alkyl chains on silica USP L1	251
	NUCLEOGEL® RP 300	Polystyrene – divinylbenzene polymer USP L21	252
Reversed phase chromatography of small molecules	NUCLEOGEL® RP 100	Small pore macroporous PS-DVB polymer USP L21	252
Food analysis · sugars and organic acids			
RP chromatography of organic acids	NUCLEODUR® C ₁₈ OA	Reversed phase with polar selectivity for organic acid analysis	253
RP chromatography of mono- and oligosaccharides	NUCLEOSIL® Carbohydrate	Silica-based special amino phase USP L8	254
Separation of sugars, alcohols, org. acids based on ion exclusion, ion exchange, size exclusion, ligand exchange, NP and RP effects	NUCLEOGEL® SUGAR 810 H, Ca	Resins with sulfonic acid modification in different ionic forms H form USP L17 / Ca form L19 / Pb form L34 / Na form L58	255
Separation of sugars, alcohols, org. acids based on steric exclusion, ligand exchange and partition effects	NUCLEOGEL® SUGAR Ca, Na, Pb NUCLEOGEL® ION 300 OA		
Gel permeation chromatography (GPC)			
Water-insoluble compounds	NUCLEOGEL® GPC	Polystyrene – divinylbenzene polymer	257

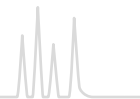

NUCLEODUR® PFAS special reversed phase for PFAS analysis

Technical data

- Base material NUCLEODUR® silica, particle size 3 µm, pore size 110 Å; pH stability 1.0 – 9.0

Recommended application

- Analysis of PFAS

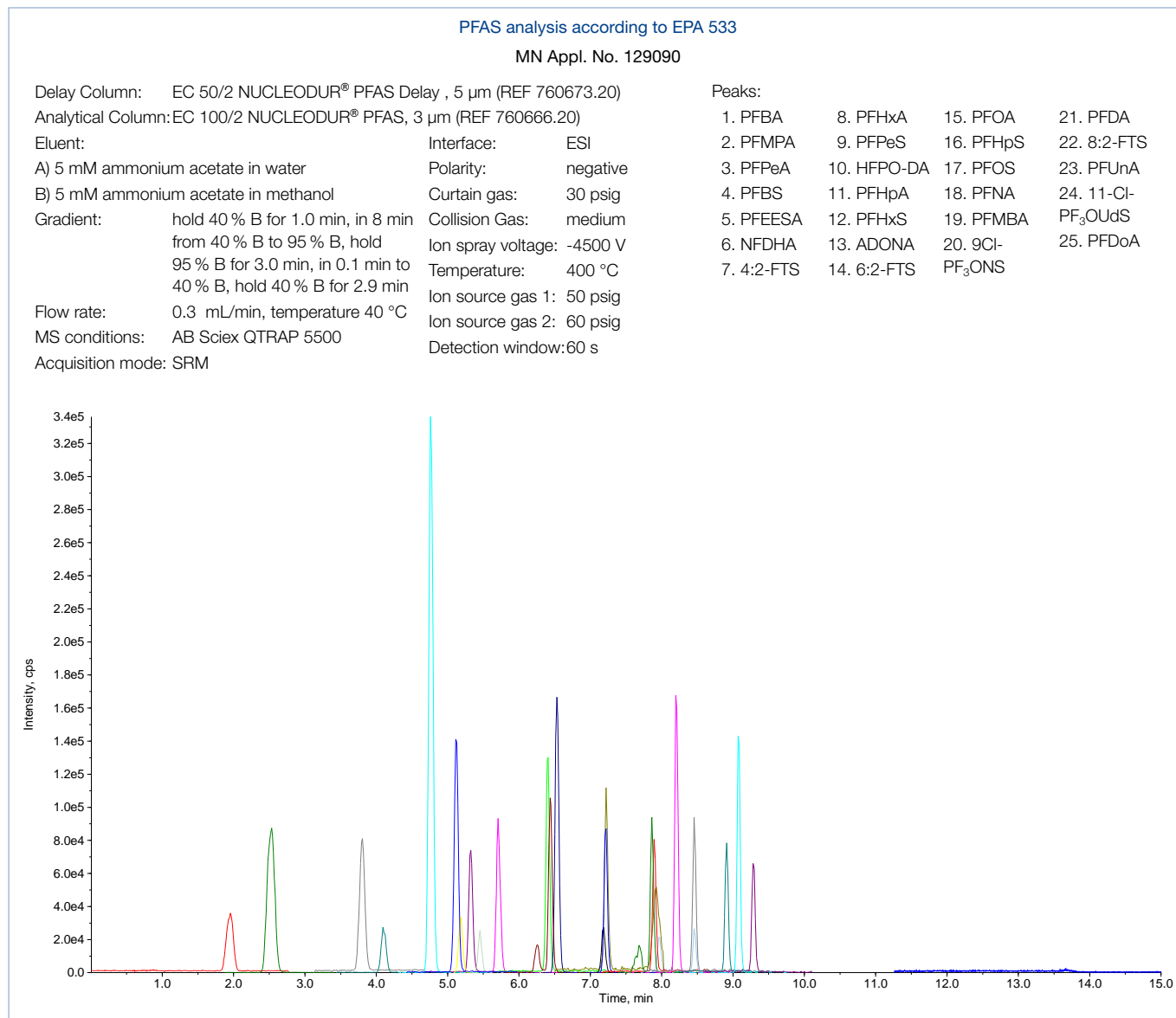

Chromatogram of PFAS according to EPA 533 on NUCLEODUR® PFAS EC 100/2 mm column (β = 1.0 ng/mL for each compound)

Eluent in column acetonitrile – water (70:30, v/v)

ID	Length → 50 mm	100 mm
NUCLEODUR® PFAS, 3 µm; particle size 3 µm		
Analytical EC columns		
2 mm	760663.20	760666.20
NUCLEODUR® PFAS Delay, 5 µm; particle size 5 µm		
Delay column		
2 mm	760673.20	



Analysis of per- and polyfluoroalkyl substances (PFAS) by HPLC

PFAS are organic compounds with a carbon chain in which hydrogen is substituted by fluorine. The carbon-fluorine bond is very strong which makes them “virtually indestructible”, so that these chemicals are very persistent in the environment and in the human body.

The molecular structure of the PFAS provides them with non-sticky and tensid-like characteristics (because of their hydrophobic, lipophilic chain + hydrophilic head). There are thousands of different compounds which are commonly used for more than 80 years for various purposes in daily life, e. g. textiles, fire extinguisher foams, food packing or cookware. Health effects were neglected for a long time. In September 2020, the European Food Safety Authority (EFSA) published a new health risk assessment related to the presence of PFAS in food. Many institutions worldwide are working on global regulation and monitoring of PFAS. As toxicological information and additional PFAS compounds become identified in the future, further directives, restrictions, and regulations will be issued over time. Chromatographic analysis will help us quantify the impact and make monitoring possible.

The special HPLC columns for PFAS analysis: NUCLEODUR® PFAS and NUCLEODUR® PFAS Delay

NUCLEODUR® PFAS, 3 µm HPLC columns provide a solution for analyzing PFAS substances.

These columns show a high batch-to-batch reproducibility, are specially batch tested for PFAS analyses and are very well suited for LC-MS due to a low bleeding characteristics.

The NUCLEODUR® PFAS Delay column provide high retention for PFAS compounds and are used to retain PFAS contaminants from the HPLC system, which could otherwise falsify the sample to be analyzed. For this purpose the NUCLEODUR® PFAS Delay column is connected in flow direction between the mixing vessel and the sample injector.

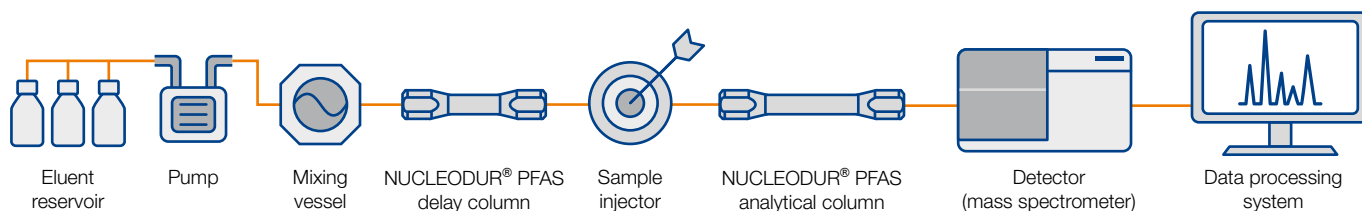



HPLC columns for environmental analyses

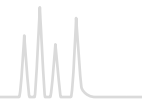

NUCLEODUR® C₁₈ PAH special octadecyl phase for PAH analysis · USP L1

Technical data

- Base material NUCLEODUR® silica, particle sizes 1.8 and 3 µm, pore size 110 Å; polymeric coating

Recommended application

- Allows efficient gradient separation of the 16 PAHs according to EPA

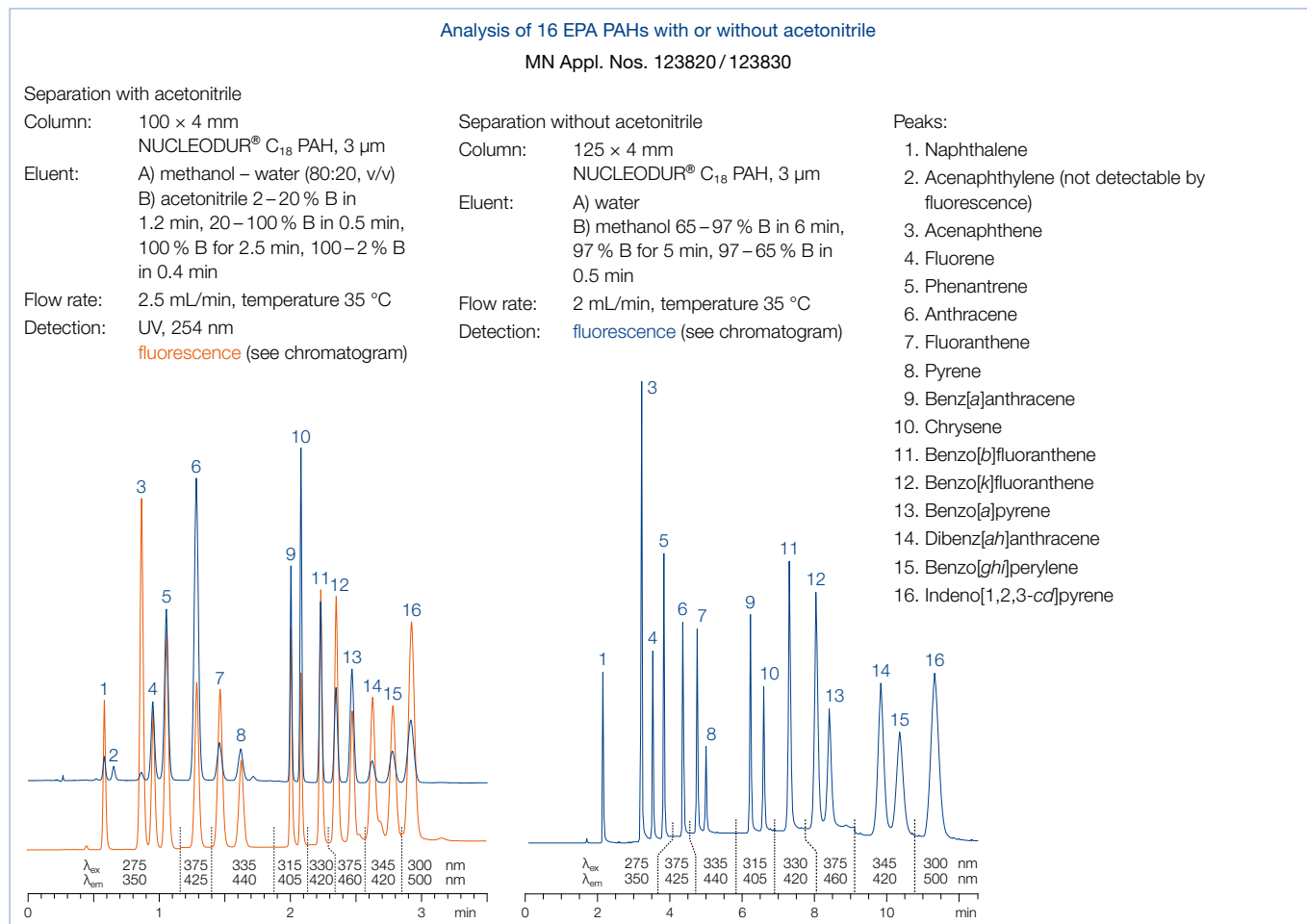

Detection of separated PAHs with UV (250–280 nm), diode array or fluorescence detection at different wavelengths for excitation and emission (acenaphthylene cannot be analyzed with fluorescence detection).

Eluent in column acetonitrile – water (70:30, v/v)

ID	Length → 100 mm	125 mm			150 mm			250 mm			EC guard columns*
NUCLEODUR® C ₁₈ PAH, 1.8 µm; particle size 1.8 µm · UHPLC											
Analytical EC columns											
	2 mm	760773.20									761970.20
	3 mm	760773.30									761970.30
	4 mm	760773.40									761970.30
NUCLEODUR® C ₁₈ PAH, 3 µm; particle size 3 µm											
Analytical EC columns											
	3 mm	760783.30	760784.30		760785.30		760786.30				761971.30
	4 mm	760783.40	760784.40		760785.40		760786.40				761971.30

Guard column system

Guard columns for EC columns with ID	2 mm	3 mm	4 mm	4.6 mm	Guard column holder
* Column Protection System (pack of)	EC	4/2 (3)	4/3 (3)	4/3 (3)	718966



Separation of 18 PAHs on NUCLEODUR® C₁₈ PAH

MN Appl. No. 123840

Column: 125 × 4 mm
NUCLEODUR® C₁₈ PAH, 3 μm

Eluent: A) methanol – water
(70:30, v/v); B) acetonitrile
0–20 % B in 1.5 min,
20–50 % B in 1.5 min,
50–100 % B in 1.0 min,
100 % B for 3 min,
100–0 % B in 0.5 min

Flow rate: 1.5 mL/min

Temperature: 35 °C

Injection: UV: 1 μL,
Fluorescence: 0.5 μL

Detection: UV, 254 nm
fluorescence
(see chromatogram)

Peaks:
(concentrations 10 ng/μL per compound)
1.–16. see page 227
1-me-n: 1-methylnaphthalene
2-me-n: 2-methylnaphthalene

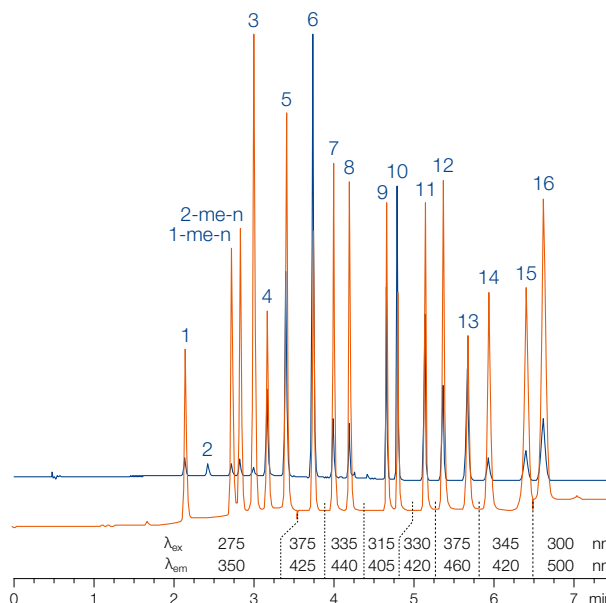

Analysis of polycyclic aromatic hydrocarbons (PAHs) by HPLC

Polycyclic aromatic hydrocarbons (PAHs) are chemical compounds that consist of fused aromatic rings and do not contain heteroatoms or carry substituents. As a pollutant, they are of concern because some compounds have been identified as carcinogenic, mutagenic, and teratogenic. PAHs are natural components of coal or gas. They are delivered to our environment by pyrolysis (incomplete burning) of organic materials like coal, oil, fuel, wood, tobacco, ... and hence can be found globally. Today most PAHs accrue from anthropogenic processes – but also natural origins (forest fire) are possible. Regarding to past pollutions an important impact had production of coke and gas from black coal. Waste products (e. g., tar) from coking or gas plants are often origin of serious ground water pollutions.

Since a number of PAHs (e. g., benzo[a]pyrene, 3-methylcholanthrene and benzantracene) have been proven to be carcinogenic, control of the PAH content of food, water and soil is an important task for routine analysis. For choice and limiting values of the polycyclics we refer to the governmental regulations, which exist in many countries (e. g., EPA method 610 of the United States Environmental Protection Agency).

PAHs can be determined by different chromatographic techniques (TLC, GC, HPLC). Thus the 6 PAHs according to German drinking water specification (TVO) can, e. g., be analyzed by TLC (see German Standard DIN 38409), while a much larger number of polycyclic aromatics can be determined by GC or HPLC.

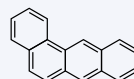

Benzo[a]anthracene

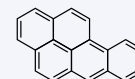

Benzo[a]pyrene

HPLC columns for PAH analysis

For PAH analyses we have developed specially modified C₁₈ phases based on NUCLEODUR® and NUCLEOSIL® which allow efficient gradient separation of 16 PAHs according to EPA. Detection of the separated PAHs can be achieved by UV (250–280 nm), with diode array or with fluorescence detection at different wavelengths for excitation and emission. Acenaphthylene cannot be analyzed with fluorescence detection. For cost-effective routine PAH analysis we recommend applications using methanol instead of acetonitrile as eluent. For rapid analysis NUCLEODUR® C₁₈ PAH (3 μm) in short columns (100 mm) provides excellent results at high flow rates. Hereby separation of 16 PAHs according to EPA can be achieved in less than 3 min.

Tightened regulations require determination of 2 additional PAHs (1- and 2-methylnaphthalene) – so we developed highly efficient methods for 18 PAHs on the NUCLEODUR® C₁₈ PAH.

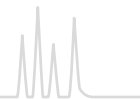

NUCLEOSIL® 100-5 C₁₈ PAH special octadecyl phase for PAH analysis · USP L1

Technical data

- Base material NUCLEOSIL® silica, particle size 5 µm, pore size 100 Å; polymeric coating
- Detection of the separated PAH with UV (250–280 nm), diode array or fluorescence detection at different wavelengths for excitation and emission (acenaphthylene cannot be analyzed with fluorescence detection)

Recommended application

- Efficient gradient separation of the 16 PAHs according to EPA

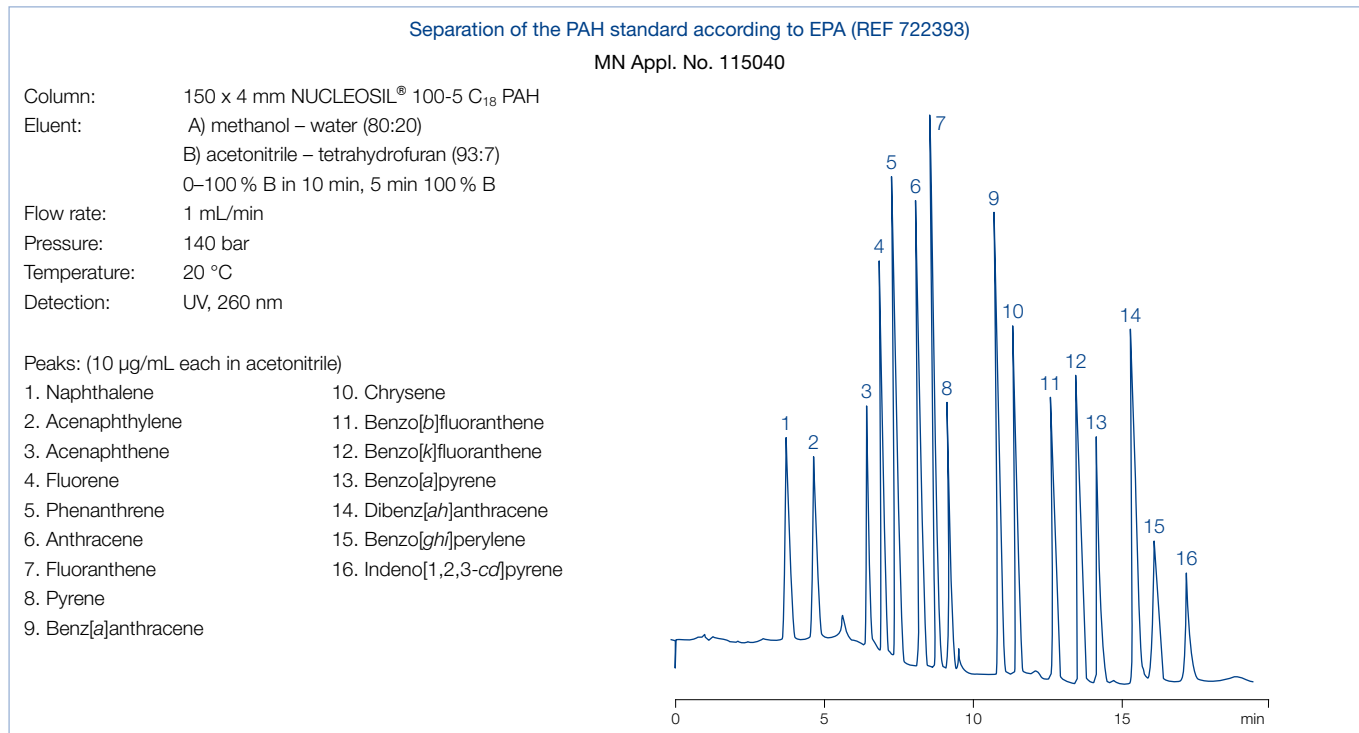

Eluent in column acetonitrile – water 70:30

ID	Length →		EC guard columns*
	150 mm	250 mm	
NUCLEOSIL® 100-5 C ₁₈ PAH; particle size 5 µm, pore size 100 Å			
Analytical EC columns			
	2 mm		720117.20 721168.20
	3 mm	720923.30	720117.30 721168.30
	4 mm	720923.40	720117.40 721168.30
	4.6 mm		720117.46 721168.30
PAH standard according to EPA for HPLC			
Analytical EC columns			
PAH standard for HPLC	16 PAH according to EPA method 610 in acetonitrile (1 mL) for composition see chromatogram above		722393

Guard column system

Guard columns for EC columns with ID	2 mm	3 mm	4 mm	4.6 mm	Guard column holder
* Column Protection System (pack of)	EC 4/2 (3)	4/3 (3)	4/3 (3)	4/3 (3)	718966

EC columns in packs of 1, guard columns in packs of 3. For details of our column systems see page 258.





Anion columns for analysis of inorganic anions

NUCLEOSIL® Anion II

Technical data

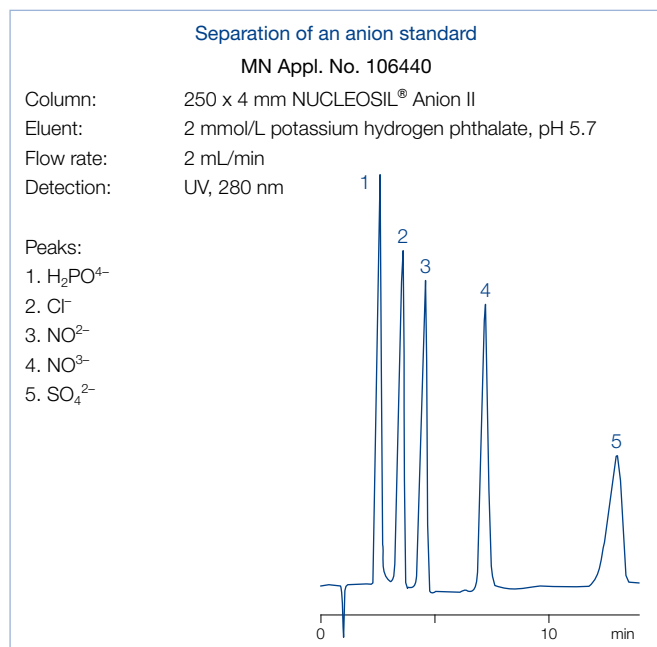
- Base material NUCLEOSIL® silica, particle size 10 µm, pore size 300 Å strongly basic anion exchanger, exchange capacity 50 µeq/g, pH stability 2–7.5
- Eluent in column 0.15 mol/L (NH₄)₂HPO₄ buffer pH 5.2 recommended buffer concentration for separation of inorganic anions: 2 mmol/L phthalate
- Preferred method of detection: conductivity or negative UV detection



ID	Length →	Guard columns*
NUCLEOSIL® Anion II; eluent 0.15 mol/L (NH ₄) ₂ HPO ₄ buffer pH 5.2	120 mm 250 mm	
Analytical EC columns		
 4 mm	720094.40	721169.30

NUCLEOSIL® Anion II guard columns are used with the Column Protection System (REF 718966, see page 259).

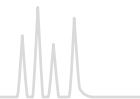

NUCLEODEX columns enantiomer separation based on cyclodextrins

NUCLEODEX β -OH β -cyclodextrin (R = H; n = 2) · USP L45

🔧 Technical data

- Base material NUCLEOSIL® silica, particle size 5 μm , pore size 100 \AA modified cyclodextrins as chiral selectors
- Separation based on hydrogen bonds and dipole interactions between functional groups of the analyte and hydroxyl groups of the cyclodextrin
- Examples for successful enantiomer separations: chlorthalidone and other compounds, which require free hydroxyl groups for enantioselective interactions
- Eluent in column CH_3OH – 0.1 % TEAA pH 4 (55:45)

NUCLEODEX α -PM permethylated α -cyclodextrin (R = CH_3 ; n = 1)

🔧 Technical data

- Base material NUCLEOSIL® silica, particle size 5 μm , pore size 100 \AA modified cyclodextrins as chiral selectors
- Examples for successful enantiomer separations: mecoprop and dichlorprop as free carboxylic acids, *trans*-stilbene oxide, styrene oxide
- Eluent in column CH_3OH – 50 mmol/L phosphate pH 3 (70:30)

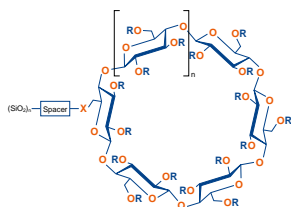

NUCLEODEX β -PM permethylated β -cyclodextrin (R = CH_3 ; n = 2) · USP L45

🔧 Technical data

- Base material NUCLEOSIL® silica, particle size 5 μm , pore size 100 \AA modified cyclodextrins as chiral selectors
- Examples for successful enantiomer separations: mephobarbital (prominal), pesticide derivatives mecoprop methyl and dichlorprop methyl
- Eluent in column CH_3OH – 0.1 % TEAA pH 4 (65:35)

NUCLEODEX γ -PM permethylated γ -cyclodextrin (R = CH_3 ; n = 3)

🔧 Technical data

- Base material NUCLEOSIL® silica, particle size 5 μm , pore size 100 \AA modified cyclodextrins as chiral selectors
- Examples for successful enantiomer separations: steroids or other larger molecules
- Eluent in column CH_3OH – 0.1 % TEAA pH 4 (55:45)

✔ Recommended application

- NUCLEODEX phases are especially suited for the control of optical purity, but also for semipreparative separations and for the analysis of positional and *cis-trans* isomers.
- For numerous separations on NUCLEODEX phases please visit our website: <https://chromaappdb.mn-net.com/>



HPLC columns for enantiomer separations



Separation of the positional isomers of nitroaniline

MN Appl. No. 101420

Column: 200 x 4 mm NUCLEODEX β -OH
 Eluent: methanol – 0.1 % triethylammonium acetate pH 4.0 (50:50, v/v)
 Flow rate: 0.7 mL/min
 Pressure: 180 bar
 Detection: UV, 254 nm
 Injection: 1 μ L

Peaks:
 1. *m*-Nitroaniline
 2. *o*-Nitroaniline
 3. *p*-Nitroaniline

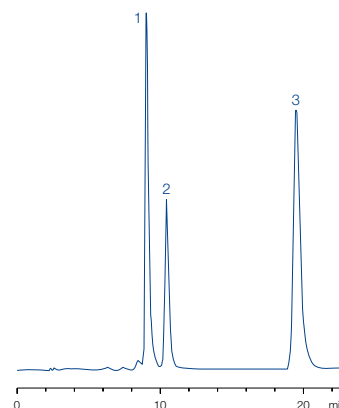

Enantiomer separation of styrene oxide

MN Appl. No. 106160

Column: 200 x 4 mm NUCLEODEX α -PM
 Eluent: methanol – 0.1 % triethylammonium acetate pH 4.0 (60:40, v/v)
 Flow rate: 0.7 mL/min
 Pressure: 160 bar
 Detection: UV, 230 nm
 Injection: 2 μ L

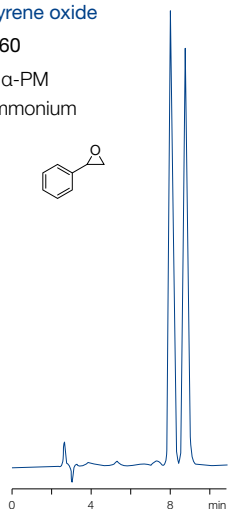



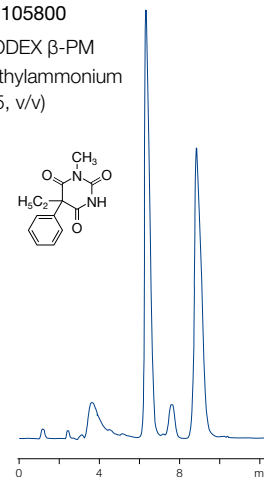
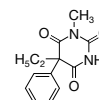

Enantiomer separation of mephobarbital

MN Appl. No. 105800

Column: 200 x 4 mm NUCLEODEX β -PM
 Eluent: methanol – 0.1 % triethylammonium acetate pH 4.0 (55:45, v/v)
 Flow rate: 0.7 mL/min
 Pressure: 180 bar
 Detection: UV, 254 nm
 Injection: 1 μ L



ID	Length → 200 mm	EC guard columns*
NUCLEODEX β -OH; eluent methanol – 0.1 % TEAA pH 4 (55:45)		
Analytical EC columns		
 4 mm	720124.40	721171.30
NUCLEODEX α -PM; eluent methanol – 50 mmol/L phosphate pH 3 (70:30)		
Analytical EC columns		
 4 mm	720127.40	721469.30
NUCLEODEX β -PM; eluent methanol – 0.1 % TEAA pH 4 (65:35)		
Analytical EC columns		
 4 mm	720125.40	721176.30
NUCLEODEX γ -PM; eluent methanol – 0.1 % TEAA pH 4 (55:45)		
Analytical EC columns		
 4 mm	720752.40	721178.30
NUCLEODEX CC screening kit		
contains one CC 30/4 each with NUCLEODEX β -OH, α -PM, β -PM and γ -PM as well as one CC column holder 30 mm		721920

* EC 4/3 guard columns for EC columns with 4 mm ID require the Column Protection System guard column holder (REF 718966, see page 259). Columns and guard columns in packs of 1.



HPLC columns for enantiomer separations

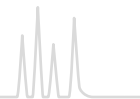

NUCLEOCEL *DELTA* enantiomer separation based on a cellulose derivative · USP L40

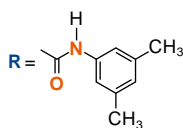
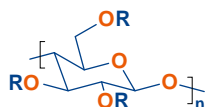

Technical data

- Base material silica, chiral selector cellulose tris-(3,5-dimethylphenylcarbamate)
High resolution type (S) with 5 µm particle size, allows use of shorter columns (150 mm) for faster separations, pressure stability up to ~150 bar (2,000 psi), pH stability 1 – 9
- NUCLEOCEL *DELTA* for normal phase applications: eluent in column *n*-heptane – 2-propanol (90:10, v/v) typical eluents are heptane – propanol mixtures
- NUCLEOCEL *DELTA*-RP for reversed phase applications: eluent in column acetonitrile – water (40:60, v/v) designed for use either in polar organic mode or with eluents containing high concentrations of chaotropic salts such as perchlorate

Recommended application

- Pharmaceutically active compounds, chiral pollutants (e.g., herbicides, PCB), chiral compounds in food (dyes, preservatives), chiral catalysts and bioorganic compounds

Similar phases: Chiralcel® OD, Kromasil® CelluCoat™, Eurocel® 01, Lux™ Cellulose-1

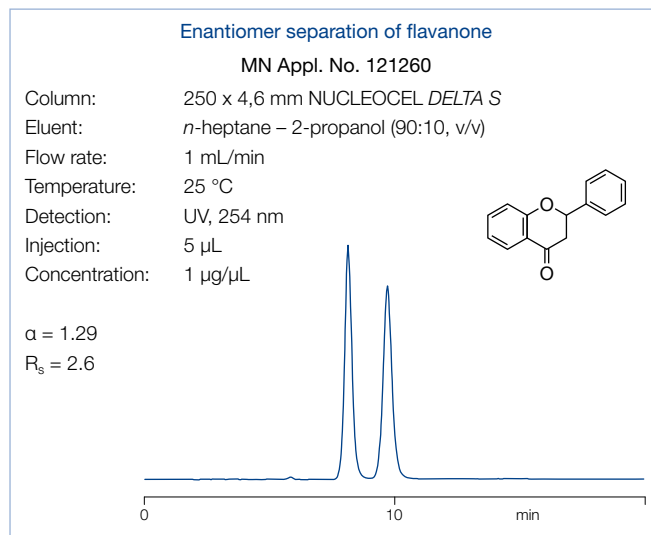
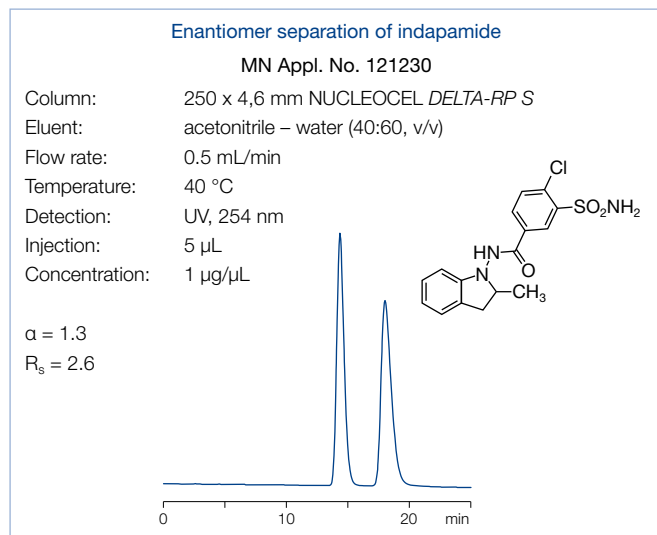

ID	Length →		EC guard columns*
	150 mm	250 mm	
NUCLEOCEL <i>DELTA</i> S, 5 µm; eluent <i>n</i> -heptane – 2-propanol (90:10, v/v)			
Analytical EC columns			
4.6 mm		720445.46	721185.30
NUCLEOCEL <i>DELTA</i> -RP S, 5 µm; eluent acetonitrile – water (40:60, v/v)			
Analytical EC columns			
4.6 mm	720451.46	720450.46	721186.30

* EC 4/3 guard column cartridges are used for EC columns of 4.6 mm ID with the Column Protection System guard column holder (REF 718966, see page 259). Columns and guard columns in packs of 1.

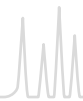

HPLC columns for enantiomer separations



RESOLVOSIL BSA-7 protein phase for enantiomer separation · USP L75

Technical data

- Base material NUCLEOSIL® silica, particle size 7 µm, pore size 300 Å chiral selector bovine serum albumin (BSA)
- Separation based on selective interaction of proteins with low molecular compounds, i. e. principles of bioaffinity, including hydrophobic interactions (similar to a true reversed phase), interactions of polar groups and steric effects

Recommended application

- Amino acid derivatives, aromatic amino acids, aromatic sulfoxides, barbiturates, benzodiazepinones, benzoin and benzoin derivatives, β-blockers, coumarin derivatives, and for monitoring stereoselective microbial and enzymatic conversions

Enantiomer separation of *N*-benzoyl-*D,L*-amino acids

MN Appl. No. 105450

S. Allenmark et al. in "Affinity chromatography and biological recognition" (I. Chaiken, M. Wilchek, and I. Parikh. Eds.), Academic Press, New York, 1983, 259 – 260

Column: 150 × 4 mm RESOLVOSIL BSA-7
 Eluent: 50 mmol/L phosphate buffer pH 6.5
 + 1 % 1-propanol
 Flow rate: 0.70 mL/min
 Detection: UV, 225 nm

- Peaks:
1. Serine
 2. Alanine
 3. Phenylalanine

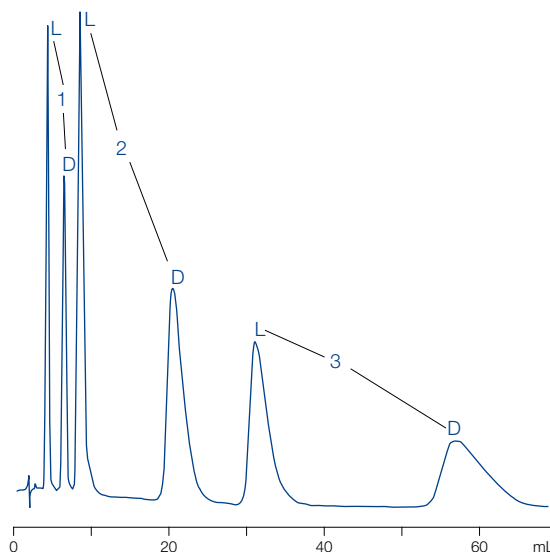

Eluent in column 0.1 mol/L phosphate buffer pH 7.5, 2 % 1-propanol

ID	Length → 150 mm	EC guard columns*
RESOLVOSIL BSA-7		
Analytical EC columns		
 4 mm	720046.40	721402.30

* EC 4/3 guard columns for EC columns with 4 mm ID require the Column Protection System guard column holder (REF 718966, see page 259). Columns and guard columns in packs of 1.



HPLC columns for enantiomer separations

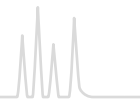

NUCLEOSIL® CHIRAL-1 enantiomer separation based on ligand exchange · USP L32

Technical data

- Base material NUCLEOSIL® silica, particle size 5 µm, pore size 120 Å chiral selector *L*-hydroxyproline – Cu²⁺ complexes
- Principal interaction mode:
 - formation of ternary mixed-ligand complexes with Cu(II) ions; differences in the stability of the diastereomeric complexes cause chromatographic separation

Recommended application

- Enantiomers with two polar functional groups with the correct spacing such as α-amino acids, α-hydroxycarboxylic acids (e.g., lactic acid), *N*-alkyl-α-amino acids etc.

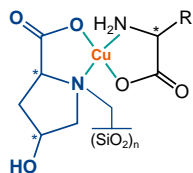

D,L-alanine enantiomers

MN Appl. No. 105410

Column: 250 x 4 mm NUCLEOSIL® CHIRAL-1
 Eluent: 0.5 mmol/L CuSO₄
 Flow rate: 1 mL/min
 Pressure: 60 bar
 Temperature: 60 °C
 Detection: UV, 250 nm

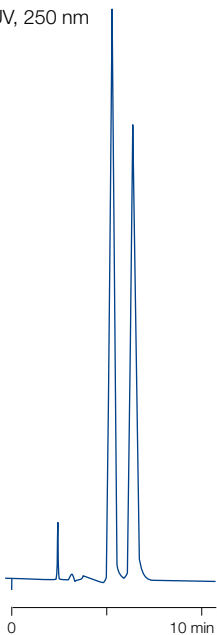

D,L-threonine enantiomers

MN Appl. No. 105410

Column: 250 x 4 mm NUCLEOSIL® CHIRAL-1
 Eluent: 0.25 mmol/L CuSO₄
 Flow rate: 0.8 mL/min
 Pressure: 65 bar
 Temperature: 60 °C
 Detection: UV, 240 nm

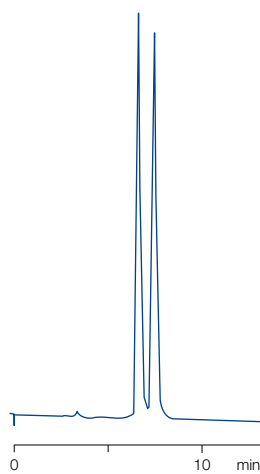

Lactic acid enantiomers

MN Appl. No. 105560

Column: 250 x 4 mm NUCLEOSIL® CHIRAL-1
 Eluent: 0.5 mmol/L CuSO₄
 Flow rate: 0.8 mL/min
 Temperature: 60 °C
 Detection: UV, 240 nm
 Injection: 1 µL

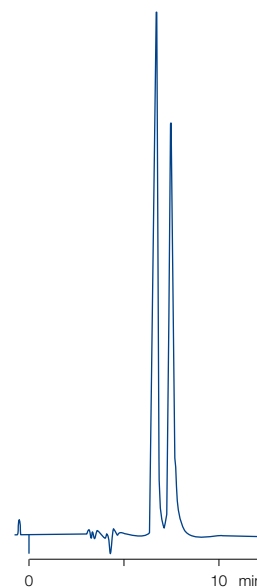

Eluent in column 0.5 mmol/L copper sulfate solution

ID	Length → 250 mm	EC guard columns*
NUCLEOSIL® CHIRAL-1		
Analytical EC columns		
4 mm	720081.40	721188.30

* EC 4/3 guard columns for EC columns with 4 mm ID require the Column Protection System guard column holder (REF 718966, see page 259). Columns and guard columns in packs of 1.



NUCLEOSIL® CHIRAL-2 · CHIRAL-3 enantiomer separation in organic eluent systems · USP L36

Technical data

- Base material NUCLEOSIL® silica, particle size 5 µm, pore size 100 Å chiral selector for NUCLEOSIL® CHIRAL-2 is *N*-(3,5-dinitrobenzoyl)-*D*-phenylglycine, for CHIRAL-3 the optical antipode is used, "brush type" phases
- Principle interaction modes: charge-transfer interactions, hydrogen bonds, dipole-dipole interactions and steric effects

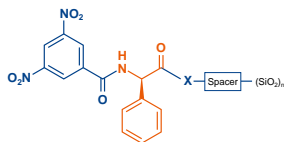

Recommended application

- analysis of stereoisomers such as separation of enantiomers and diastereomers, control of optical purity of plant protectives (pesticides, e. g., propionic acid derived herbicides) pharmaceuticals etc. and for product control in chiral organic syntheses
- For control of optical purity of a substance, the columns NUCLEOSIL® CHIRAL-2 and NUCLEOSIL® CHIRAL-3 allow to select conditions such that the minor enantiomer, present as an impurity, is eluted before the main peak. Overlapping peaks are avoided. This makes an exact quantification of the impurity much easier.

Enantiomer separation of *D,L*-supidimide

MN Appl. No. 105690

Column: 250 x 4 mm NUCLEOSIL® CHIRAL-2
 Eluent: tetrahydrofuran – *n*-heptane (10:3, v/v)
 Flow rate: 1.0 mL/min
 Detection: UV, 220 nm

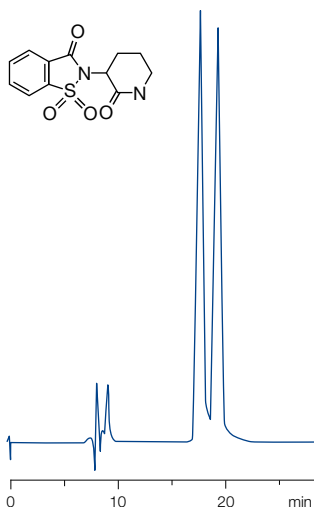

Control of optical purity of mecoprop methyl

MN Appl. No. 111360

Columns: a) 250 x 4 mm NUCLEOSIL® CHIRAL-2
 b) 250 x 4 mm NUCLEOSIL® CHIRAL-3
 Eluent: *n*-heptane – 2-propanol – TFA (100:0.05:0.05, v/v/v)
 Flow rate: 1 mL/min, ambient temperature
 Detection: UV, 230 nm, injection 1 µL (sample with 90 % ee)

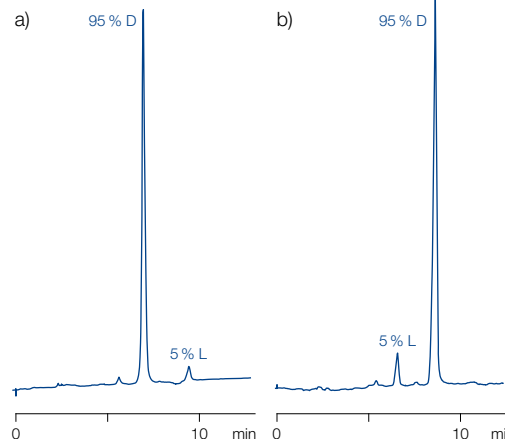

Eluent in column *n*-heptane – 2-propanol – TFAA (100:0.05:0.05, v/v/v)

ID	Length → 250 mm	EC guard columns*
NUCLEOSIL® CHIRAL-2		
Analytical EC columns		
4 mm	720088.40	721190.30
NUCLEOSIL® CHIRAL-3		
Analytical EC columns		
4 mm	720350.40	721190.30

Guard columns for NUCLEOSIL® CHIRAL-2 and CHIRAL-3 are identical.

* EC 4/3 guard columns for EC columns with 4 mm ID require the Column Protection System guard column holder (REF 718966, see page 259). EC columns and EC guard columns in packs of 1.

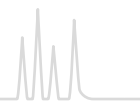

NUCLEOGEN® columns anion exchange chromatography of nucleic acids

NUCLEOGEN® 60-7 DEAE pore size 60 Å

Technical data

- Base material silica, particle size 7 µm; DEAE anion exchanger
- For the separation of oligonucleotides up to chain lengths of 40 bases with recoveries > 95 % capacity 200 A₂₆₀/mL (~ 300 A₂₆₀ for a 125 × 4 mm ID column, 1875 A₂₆₀ for a 125 × 10 mm ID column)
- Preparative separations possible when using higher flow rates and longer gradient times

NUCLEOGEN® 500-7 DEAE pore size 500 Å

Technical data

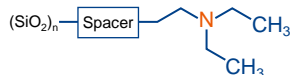

- Base material silica, particle size 7 µm; DEAE anion exchanger
- For the separation of tRNA, 5S RNA, viroids and messenger RNA in the intermediate molecular weight range (25 – 1,000 kDa) with recoveries > 95 %
- Capacity 730 A₂₆₀ for a 125 × 6 mm ID column, 1940 A₂₆₀ for a 125 × 10 mm ID column

NUCLEOGEN® 4000-7 DEAE pore size 4000 Å

Technical data

- Base material silica, particle size 7 µm; DEAE anion exchanger
- For the separation of plasmids, DNA restriction fragments, ribosomal RNA, messenger RNA and viral RNA, i. e. very high molecular weight nucleic acids (e. g., 1 – 50 MDa)
- Capacity 120 A₂₆₀ for a 125 × 6 mm ID column, 350 A₂₆₀ for a 125 × 10 mm ID column

For more separations of deoxyoligonucleotides, plasmids and DNA restriction fragments visit our website <https://chromaappdb.mn-net.com/>



Separation of plasmid pBR 322

MN Appl. No. 107480

M. Colpan, D. Riesner, private communication

A) isolation of plasmid DNA from a crude cell lysate

Sample: 5 µg plasmid pBR 322 containing cleared lysate from *E. coli*

Column: 125 × 6 mm NUCLEOGEN® 4000-7 DEAE

Eluent: A) 20 mmol/L K phosphate buffer pH 6.9; 5 mol/L urea
B) eluent A + 1.5 mol/L KCl
20 – 100 % B in 50 min;
arrow = ionic strength of 850 mmol/L

Flow rate: 1.0 mL/min, 70 bar

Temperature: ambient

Detection: UV, 260 nm

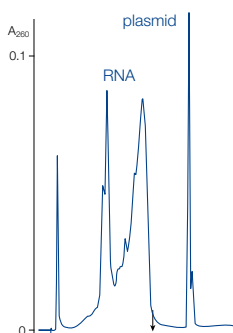

B) separation of supercoiled plasmid from relaxed and linear forms

Sample: plasmid pBR 322, supercoiled, relaxed and linear

Column: 125 × 6 mm NUCLEOGEN® 4000-7 DEAE

Eluent: A) 20 mmol/L K phosphate buffer pH 6.8; 6 mol/L urea
B) eluent A + 2 mol/L KCl
42 – 100 % B in 230 min

Flow rate: 1.5 mL/min, 45 bar

Temperature: ambient

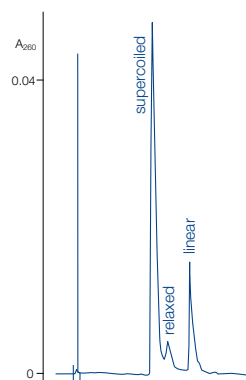

Separation of oligo(rA)_n

MN Appl. No. 115180

Column: 125 × 4 mm NUCLEOGEN® 60-7 DEAE

Eluent: A) 20 mmol/L phosphate buffer, pH 5.5, 5 mol/L urea
B) buffer A + 1 mol/L KCl
0-100 % B in 200 min

Flow rate: 2 mL/min

Pressure: 110 bar

Temperature: ambient

Detection: UV, 260 nm

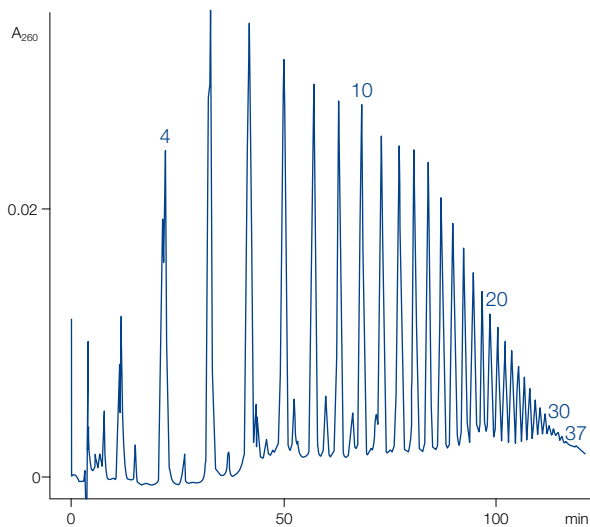

Preparative separation of a crude RNA extract of viroid (PSTV) infected tomato plants

MN Appl. No. 107490

D. Riesner, BioEngineering 1 (1988) 42-48

Column: 125 × 6 mm NUCLEOGEN® 500-7 DEAE

Eluent: A) 250 mmol/L KCl, 20 mmol/L phosphate buffer, pH 6.6, 5 mol/L urea
B) 1 mol/L KCl, 20 mmol/L phosphate buffer, pH 6.6, 5 mol/L urea
0-50 % B in 120 min, 50-100 % B in 250 min

Flow rate: 3 mL/min

Pressure: 40 bar

Temperature: ambient

Detection: 260 nm

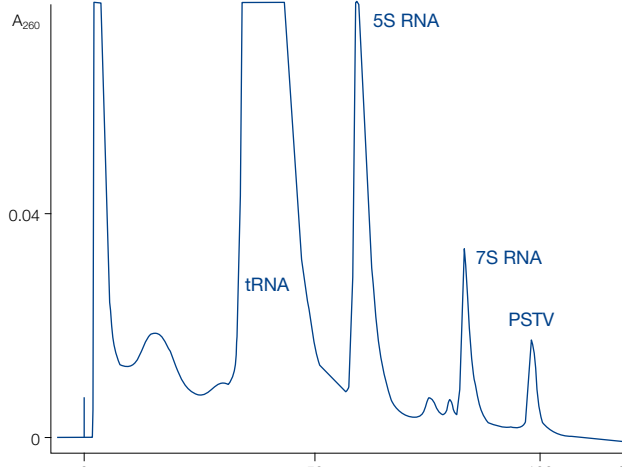





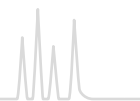



HPLC columns for biochemical separations



Eluent in column methanol

ID	Length → 125 mm	Guard columns*
NUCLEOGEN® 60-7 DEAE; particle size 7 µm, pore size 60 Å		
Analytical EC columns		
 4 mm	736596.40	736400.40
Preparative VarioPrep columns		
 10 mm	736597.100	736400.40
NUCLEOGEN® 500-7 DEAE; particle size 7 µm, pore size 500 Å		
Analytical Valco type columns		
 6 mm	736598	736400.40
Preparative VarioPrep columns		
 10 mm	736599.100	736400.40
NUCLEOGEN® 4000-7 DEAE; particle size 7 µm, pore size 4000 Å		
Analytical Valco type columns		
 6 mm	736601	736400.40
Preparative VarioPrep columns		
 10 mm	736602.100	736400.40

* NUCLEOGEN® guard columns are 30 mm long and require the CC column holder 30 mm (REF 721823).
Columns in packs of 1, guard columns in packs of 2.



HPLC columns for biochemical separations



NUCLEOGEL® SAX anion exchange of biological macromolecules · USP L23

Technical data

- Polymer-based strongly basic anion exchanger – $N^+(CH_3)_3$, gel matrix quaternized PEI; particle size 8 μm , pore size 1000 \AA
- pH working range 1 – 13, max. working pressure 200 bar

Recommended application

- Purification of peptides, large proteins and oligonucleotides, high capacity for proteins even at pH 10

NUCLEOGEL® SCX cation exchange of biological macromolecules · USP L22

Technical data



- Polymer-based strongly acidic cation exchanger – SO_3^- , hydrophilic gel matrix; particle size 8 μm , pore size 1000 \AA
- pH working range 1 – 13, max. working pressure 200 bar

Recommended application

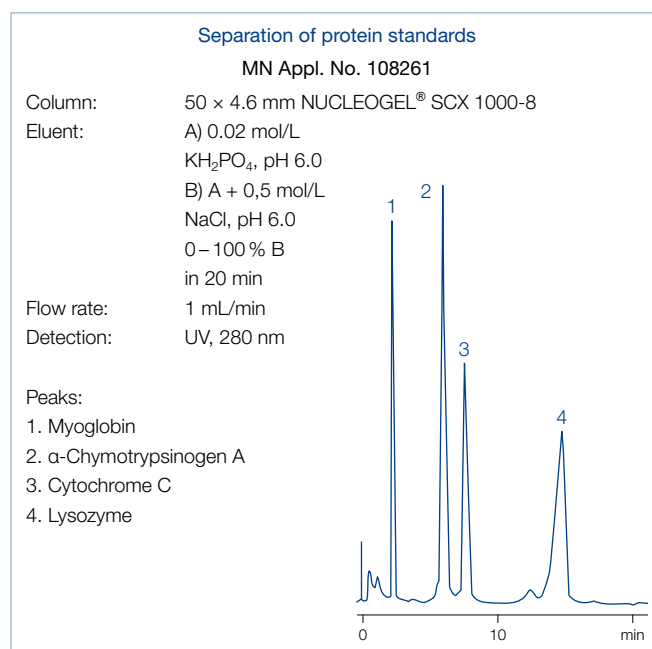
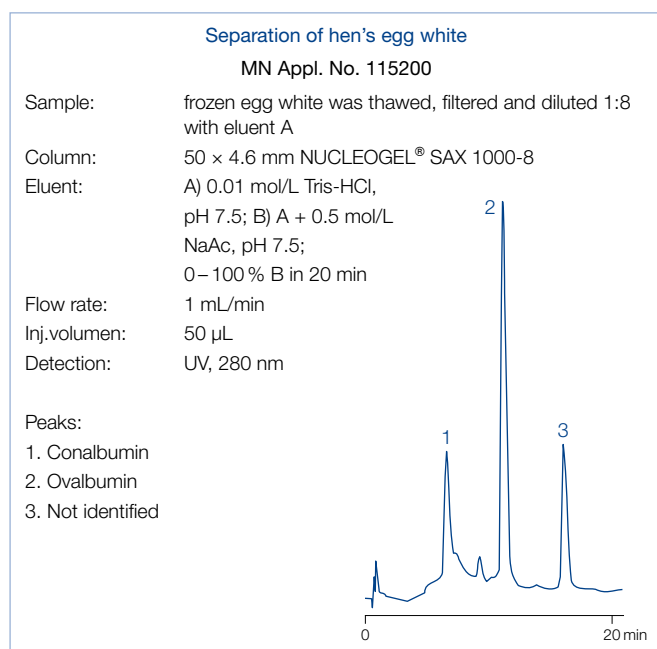
- Proteins, peptides and carbohydrates with high isoelectric point



Eluent in column 0.1 mol/L Na_2SO_4 + 0.2% NaN_3

ID	Length → 50 mm	Guard columns*
NUCLEOGEL® SAX; pore size 1000 \AA		
Analytical Valco type columns		
 4.6 mm	719469	719600
NUCLEOGEL® SCX; pore size 1000 \AA		
Analytical Valco type columns		
 4.6 mm	719475	719540

* NUCLEOGEL® SAX and SCX Valco type guard columns measure 5 x 3 mm and require the guard column holder B, REF 719539 (see page 258)
Columns in packs of 1, guard columns in packs of 2.



HPLC columns for biochemical separations

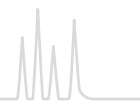

NUCLEODUR® 300 C₁₈ ec · C₄ ec wide pore silica for biochromatography · USP L1 (C₁₈) · USP L26 (C₄)

★ Key feature

- Reliable wide pore RP phases for daily routine analysis
- Medium density octadecyl or butyl modification with exhaustive endcapping
- Ideal phases for separation of biomolecules

🔧 Technical data

- Pore size 300 Å; particle size 5 µm, carbon content 4 % for C₁₈, 2.5 % for C₄; pH stability 1–9; high reproducibility from lot to lot

✓ Recommended application

- Biological macromolecules like proteins or peptides

Column selection by analyte characteristics

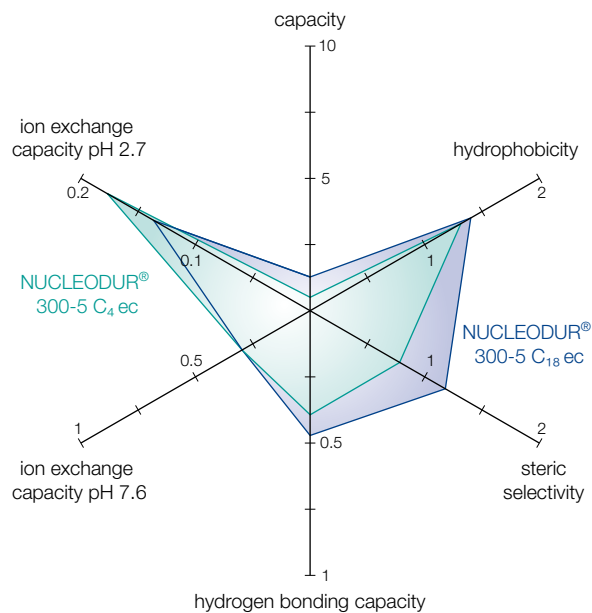
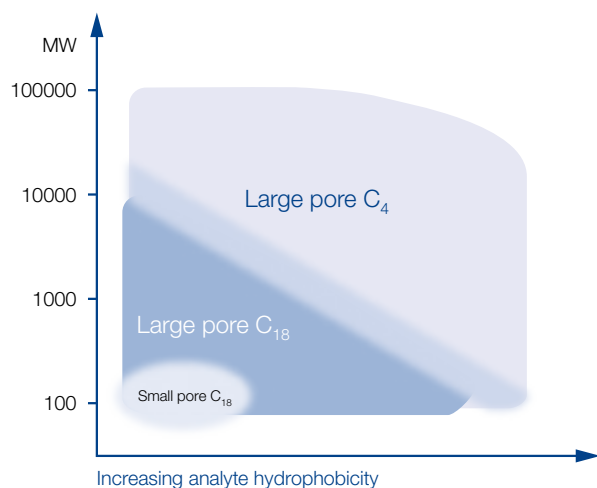

Tanaka plots of NUCLEODUR® wide pore phases

Batch-to-batch reproducibility of NUCLEODUR® 300-5 C₄ ec and NUCLEODUR® 300-5 C₁₈ ec

MN Appl. Nos. 126551 / 126552

Columns: 250 × 4 mm
 Eluent: A) 0.1 % TFA in water
 B) 0.08 % TFA in acetonitrile
 20–60 % B in 15 min
 Flow rate: 1 mL/min
 Temperature: 25 °C
 Detection: UV, 280 nm

Peaks:

1. Ribonuclease A
2. Cytochrome C
3. Lysozyme
4. BSA
5. β-Lactoglobulin
6. β-Lactoglobulin 2

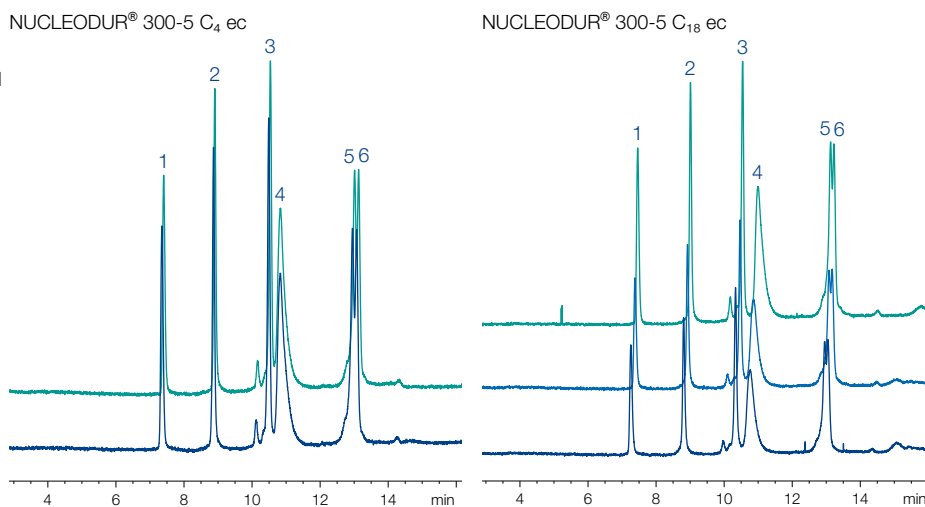



Comparison of narrow and wide pore NUCLEODUR® for the separation of proteins

MN Appl. No. 126590

Columns: 250 × 4,6 mm NUCLEODUR® 300-5 C₁₈ ec
250 × 4,6 mm NUCLEODUR® C₁₈ Gravity, 5 μm

Eluent: A) 0.1 % TFA in water
B) 0.08 % TFA in acetonitrile
20–65 % B in 15 min
(3 min 65 % B)

Flow rate: 1.3 mL/min
Temperature: 25 °C
Detection: UV, 280 nm

Peaks:

1. Ribonuclease A
2. Cytochrome C
3. Lysozyme
4. BSA
5. β-Lactoglobulin
6. β-Lactoglobulin 2

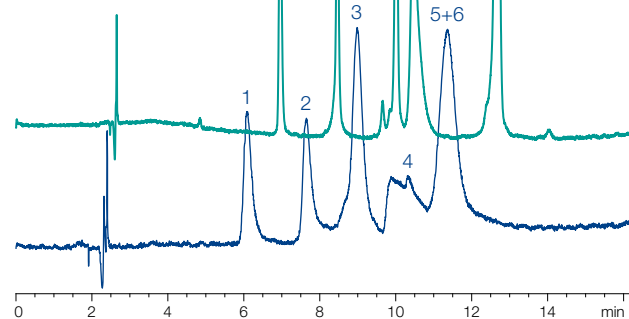

Sharper peaks of larger molecules on wide pore material

Tryptic digest of cytochrome C

MN Appl. No. 126600

Columns: 250 × 4.6 mm NUCLEODUR® 300-5 C₁₈ ec
250 × 4.6 mm Jupiter® C₁₈, 5 μm

Eluent: A) 0.1 % TFA in water
B) 0.08 % TFA in acetonitrile
5–40 % B in 15 min (1 min 40 % B)

Flow rate: 1.3 mL/min
Temperature: 30 °C
Detection: UV, 280 nm

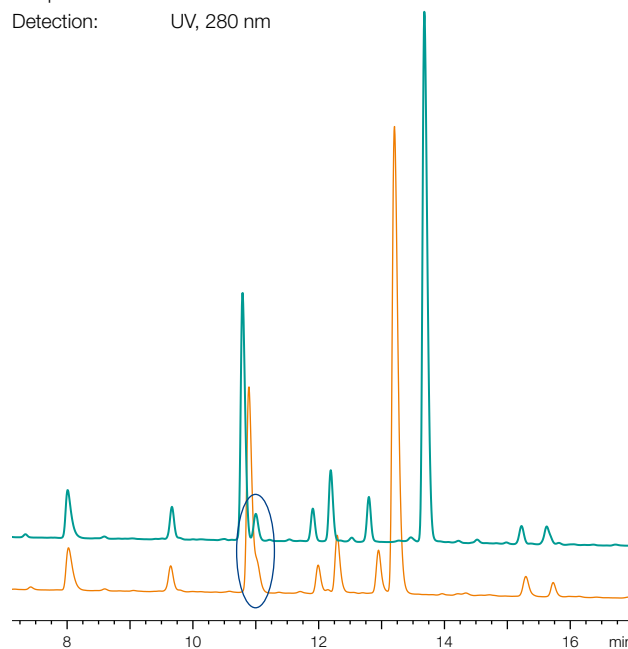

Less tailing and better separation on NUCLEODUR® 300 C₁₈ ec

Eluent in column acetonitrile – water

ID	Length → 100 mm	125 mm			150 mm		250 mm		EC guard columns*
NUCLEODUR® 30-5 C₁₈ ec; octadecyl phase, particle size 5 μm, pore size 300 Å, endcapped, 4 % C									
Analytical EC columns									
	2 mm	760183.20	760184.20	760185.20	760186.20	761988.20			
	3 mm	760183.30	760184.30	760185.30	760186.30	761988.30			
	4 mm	760183.40	760184.40	760185.40	760186.40	761988.30			
	4.6 mm	760183.46	760184.46	760185.46	760186.46	761988.30			
NUCLEODUR® 300-5 C₄ ec; butyl phase, particle size 5 μm, pore size 300 Å, endcapped, 2.5 % C									
Analytical EC columns									
	2 mm	760193.20	760194.20	760195.20	760196.20	761989.20			
	3 mm	760193.30	760194.30	760195.30	760196.30	761989.30			
	4 mm	760193.40	760194.40	760195.40	760196.40	761989.30			
	4.6 mm	760193.46	760194.46	760195.46	760196.46	761989.30			

* EC guard columns require the Column Protection System guard column holder (REF 718966, see page 259).
EC columns in packs of 1, guard columns in packs of 3.



HPLC columns for biochemical separations

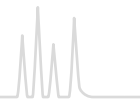

NUCLEOSIL® MPN RP chromatography of biological macromolecules

NUCLEOSIL® 100-5 C₁₈ MPN · USP L1

★ Key feature

- Octadecyl phase, particle size 5 µm; pore size 100 Å
- Dynamic protein binding capacity per g packing: 6 mg BSA, 110 mg cytochrome C
- pH working range 2–8, max. working pressure 250 bar

🔧 Technical data

- Silica-based reversed phase materials with monomerically bonded alkyl chains, brush type structure predominantly hydrophobic forces with a small portion of hydrophilic interactions
- Maximum separation efficiency can be achieved when the injected protein mass does not exceed 1–2 % of the maximum protein loading capacity.

NUCLEOSIL® 300-5 C₄ MPN · USP L26

★ Key feature

- Butyl phase, particle size 5 µm, pore size 300 Å
- Dynamic protein binding capacity per g packing: 14 mg BSA, 27 mg cytochrome C especially suited for the purification of larger, hydrophobic peptides and very different proteins
- pH working range 2–8, max. working pressure 250 bar

🔧 Technical data

- Silica-based reversed phase materials with monomerically bonded alkyl chains, brush type structure predominantly hydrophobic forces with a small portion of hydrophilic interactions
- Maximum separation efficiency can be achieved when the injected protein mass does not exceed 1–2 % of the maximum protein loading capacity.

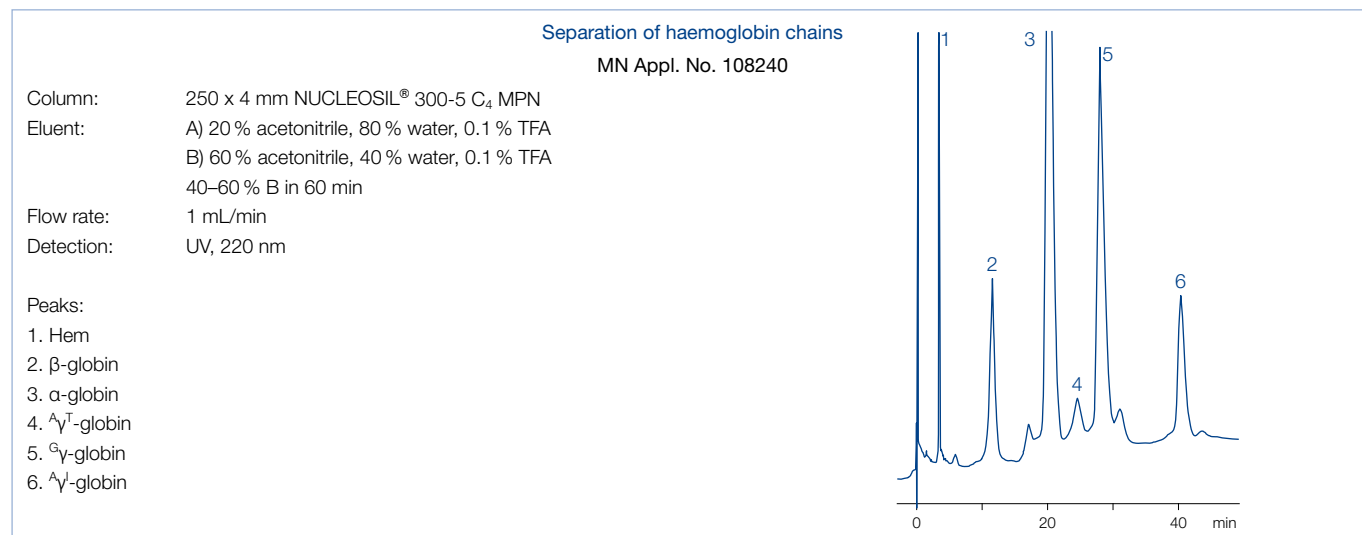

Eluent in column methanol

ID	Length → 250 mm	EC guard columns*
NUCLEOSIL® 100-5 C₁₈ MPN		
Analytical EC columns		
4 mm	720231.40	
NUCLEOSIL® 300-5 C₄ MPN		
Analytical EC columns		
4 mm	720245.40	721119.30

* EC guard columns require the Column Protection System guard column holder (REF 718966, see page 259). Columns in packs of 1, guard columns in packs of 2.



HPLC columns for biochemical separations



NUCLEOSIL® PPN RP chromatography of biological macromolecules

NUCLEOSIL® 100-5 C₁₈ PPN · USP L1

★ Key feature

- Octadecyl phase, particle size 5 μm, pore size 100 Å, dynamic protein binding capacity per g packing: 8 mg BSA, 64 mg cytochrome C; suited for the separation of peptides and proteins up to about 40 kD, also suited for basic peptides

🔧 Technical data

- Silica-based reversed phase materials with polymerically bonded alkyl chains; exclusively hydrophobic interactions
- pH working range 1–9, max. working pressure 250 bar

NUCLEOSIL® 500-5 C₁₈ PPN · USP L1

★ Key feature



- Octadecyl phase, particle size 5 μm, pore size 500 Å, dynamic protein binding capacity per g packing: 22 mg BSA, 40 mg cytochrome C; especially suited for large peptides and medium-size hydrophilic proteins

🔧 Technical data

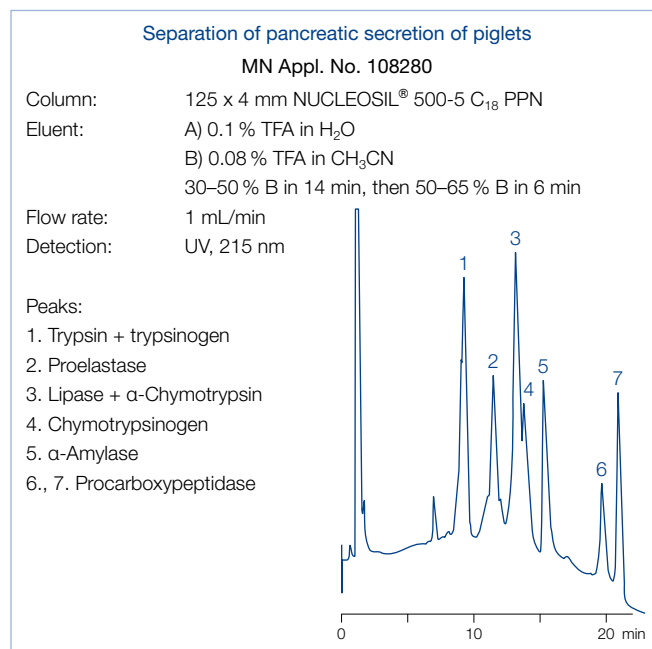
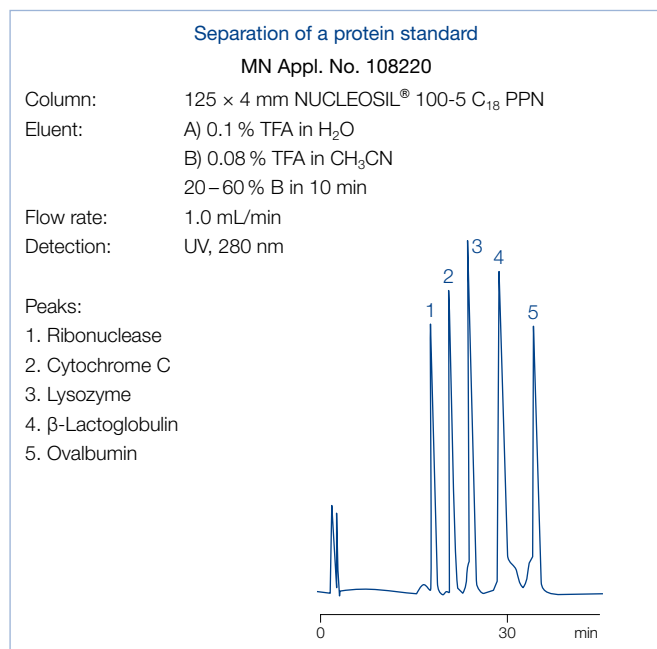
- Silica-based reversed phase materials with polymerically bonded alkyl chains; exclusively hydrophobic interactions
- pH working range 1–9, max. working pressure 250 bar



Eluent in column methanol

ID	Length → 250 mm	EC guard columns*
NUCLEOSIL® 100-5 C ₁₈ PPN; particle size 5 μm, pore size 100 Å		
Analytical EC columns		
 4 mm	720252.40	721567.30
NUCLEOSIL® 500-5 C ₁₈ PPN; particle size 5 μm, pore size 500 Å		
Analytical EC columns		
 4 mm	720258.40	721924.30

* EC guard columns require the Column Protection System guard column holder (REF 718966, see page 259). Columns in packs of 1, guard columns in packs of 2.

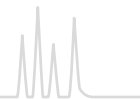

NUCLEOGEL® RP columns RP columns for biochemical applications · USP L21

Technical data

- Polystyrene resin cross-linked with divinylbenzene, available particle sizes 5 µm and 8 µm, available pore sizes 100 Å and 300 Å
- pH working range 1 – 13, max. working pressure 180 bar
- Small pore columns for reversed phase separation of small molecules such as pharmaceuticals with basic properties, e. g., organic heterocycles; also suited for separation of nucleosides and nucleotides up to 5000 Da; allow gradient as well as isocratic elution
- Wide pore columns are especially recommended for large biomolecules higher background hydrophobicity compared to silica phases

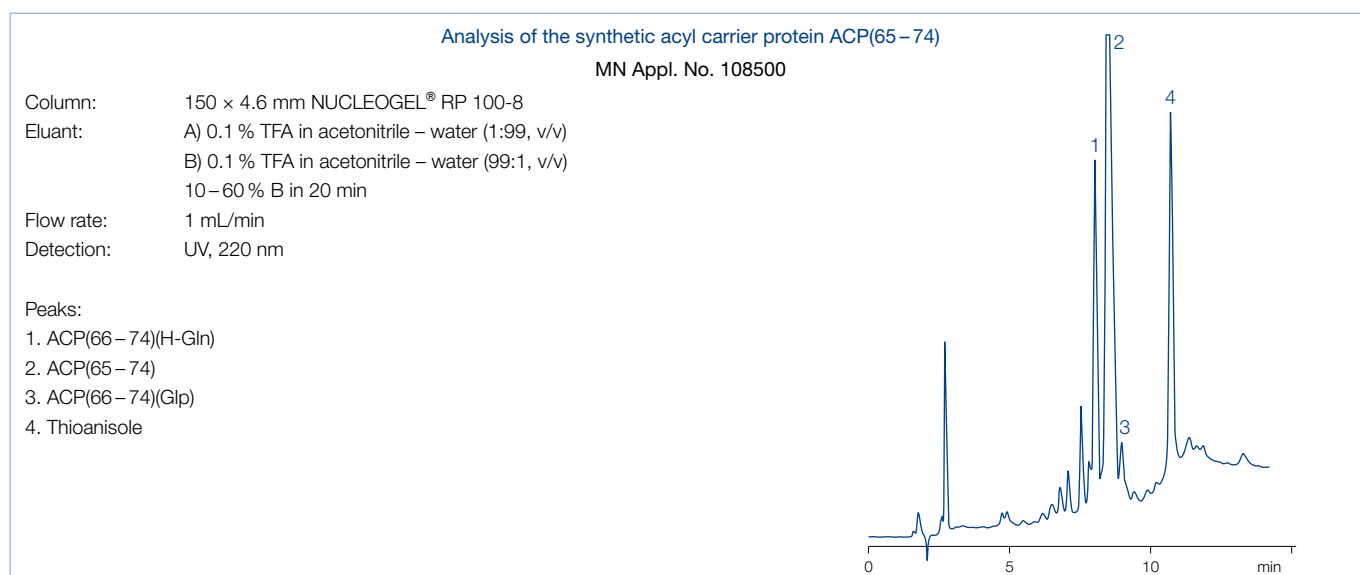

Eluent in column acetonitrile – water

ID	Length → 50 mm	150 mm		250 mm		Guard columns*
NUCLEOGEL® RP 100-5; particle size 5 µm, pore size 100 Å						
Analytical Valco type columns						
4.6 mm		719454	719455			719542
NUCLEOGEL® RP 100-8; particle size 8 µm, pore size 100 Å						
Analytical Valco type columns						
4.6 mm		719456	719520			719542
NUCLEOGEL® RP 300-5; particle size 5 µm, pore size 300 Å						
Analytical Valco type columns						
4.6 mm		719459				719542
NUCLEOGEL® RP 300-8; particle size 8 µm, pore size 300 Å						
Analytical Valco type columns						
4.6 mm		719460				719542

* Valco type guard columns measure 5 × 3 mm and require Guard column holder B, REF 719539, see page 258.
 Columns in packs of 1, guard columns in packs of 2.



HPLC columns for sugar analyses



NUCLEODUR® C₁₈ OA special octadecyl phase for organic acid analysis · USP L1

Technical data

- Base material NUCLEODUR® silica, particle size 5 µm, pore size 110 Å; pH stability 2.0 – 8.0

Recommended application

- Reversed phase with polar selectivity for organic acid analysis; suitable for usage with 100 % aqueous mobile phase

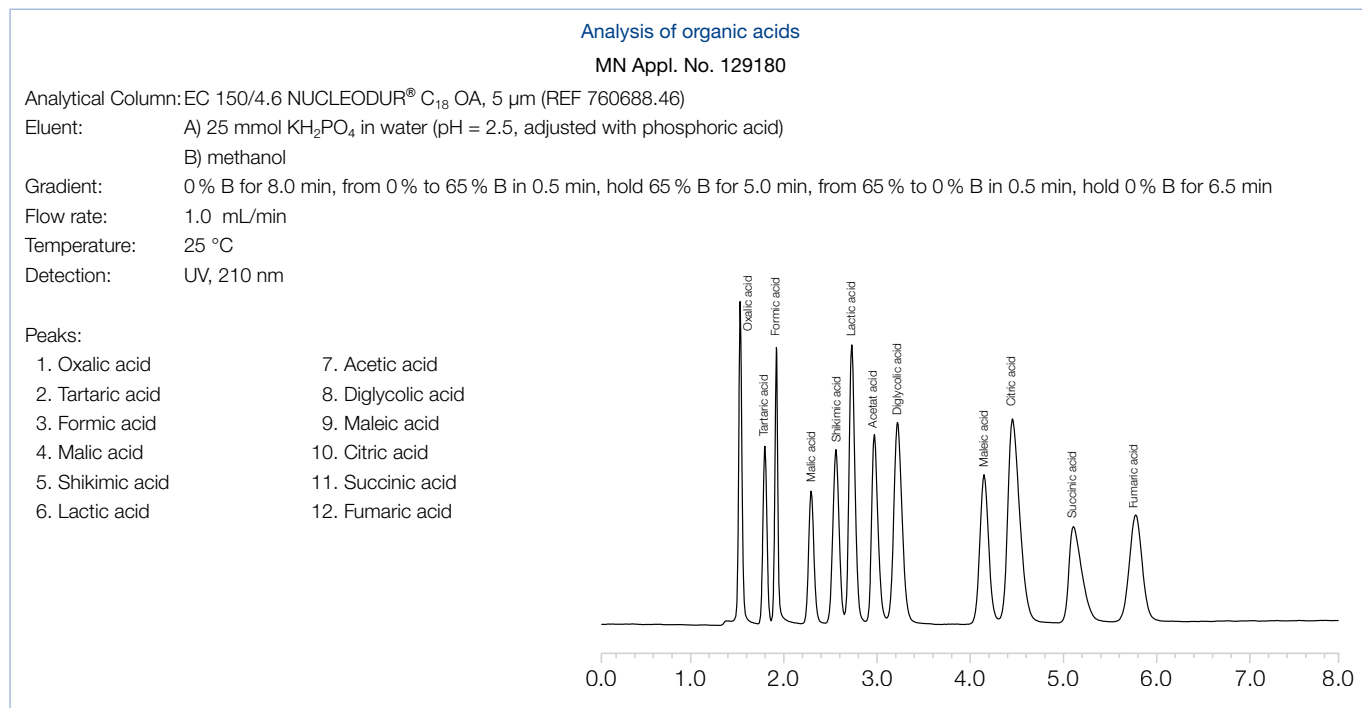

Detection of a standard mixture containing 12 organic acids.

Eluent in column acetonitrile – water

ID	Length →	
	150 mm	250 mm
NUCLEODUR® C ₁₈ OA, 5 µm; particle size 5 µm		
Analytical EC columns		
4.6 mm	760688.46	760689.46

Analysis of organic acids by HPLC

Fruits and fruit juices are globally traded products. Therefore, monitoring of organic acids is an important parameter for quality control in the processing of juices and related products, as well

as for the evaluation of the authenticity and purity of juices. In addition, the use of organic acids in foods and beverages is regulated in many countries, though regulations vary widely.



HPLC columns for sugar analyses

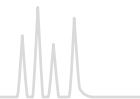

NUCLEOSIL® Carbohydrate separation of mono- and disaccharides · USP L8

Technical data

- Matrix: NUCLEOSIL® silica with amino modification, particle size 10 µm

Recommended application

- RP separation of mono- and disaccharides

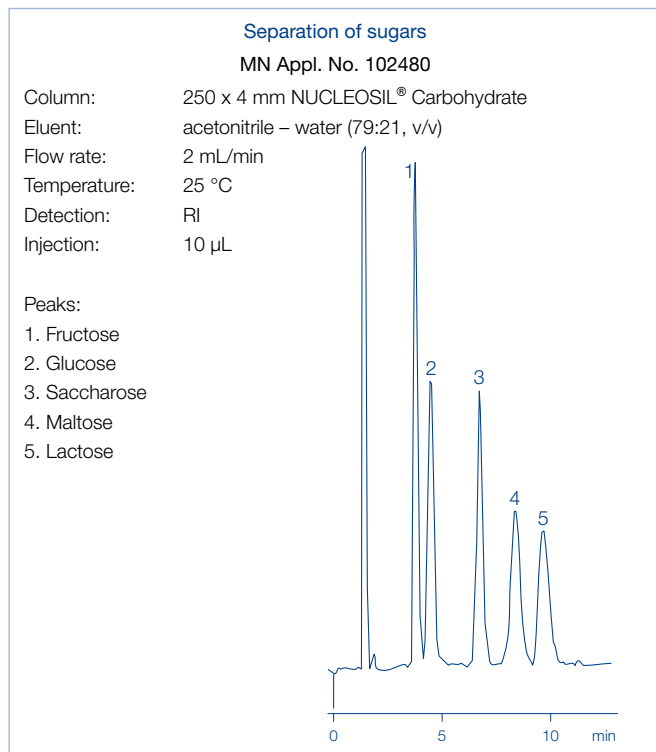

Eluent in column acetonitrile – water (79:21, v/v)

ID	Length → 250 mm	EC guard columns*
NUCLEOSIL® Carbohydrate		
Analytical EC columns		
4 mm	720905.40	721170.30

* EC 4/3 guard columns for EC columns with 4 mm ID require the Column Protection System guard column holder (REF 718966, see page 259). Columns and guard columns in packs of 1.



HPLC columns for sugar analyses

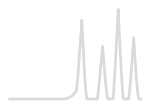

NUCLEOGEL® SUGAR 810 separation of sugars · USP L17 (H⁺ form) · USP L19 (Ca²⁺ form)

Technical data

- Sulfonated polystyrene - divinylbenzene resins in different ionic forms; due to a different selectivity pattern compared to NUCLEOGEL® SUGAR columns, the range of application is considerably enlarged
- Separation mechanism: ion exclusion, ion exchange, size exclusion, ligand exchange, NP and RP chromatography

Recommended application

- H⁺ form: Separation of sugars, sugar alcohols and organic acids; eluent in column 5 mmol/L H₂SO₄
- Ca²⁺ form: Separation of mono-, di- and oligosaccharides; eluent in column water

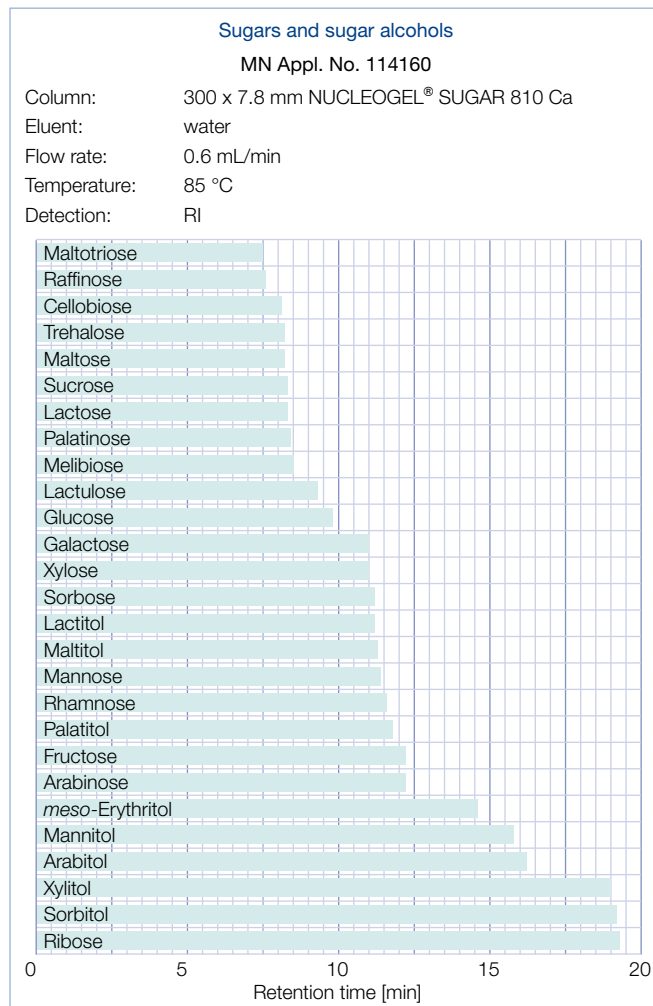
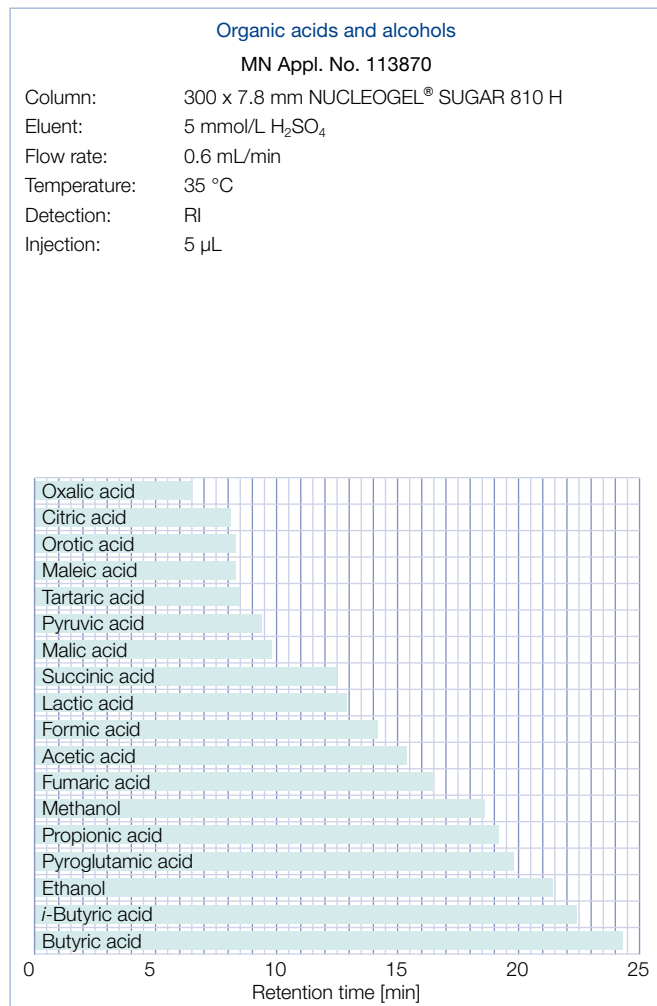

ID	Length → 300 mm	Guard columns*
NUCLEOGEL® SUGAR 810 H; eluent in column 5 mmol/L H ₂ SO ₄		
Analytical Valco type columns		
7.8 mm	719574	719575
NUCLEOGEL® SUGAR 810 Ca; eluent in column water		
Analytical Valco type columns		
7.8 mm	719570	719571

* NUCLEOGEL® SUGAR 810 guard columns measure 30 x 4 mm and require the CC column holder 30 mm (REF 721823)
Columns in packs of 1, guard columns in packs of 2.



HPLC columns for sugar analyses

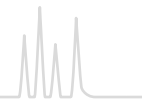

NUCLEOGEL® ION 300 OA/SUGAR

separation of sugars · USP L17 (H⁺ form) · USP L19 (Ca²⁺ form) · USP L34 (Pb²⁺ form) · USP L58 (Na⁺ form)

Technical data

- Sulfonated spherical PS/DVB resins in different ionic forms; mean particle size 10 µm, pore size 100 Å
- Separation mechanism includes steric exclusion, ligand exchange and partition effects, ligand exchange being the predominant force, since the hydrated metal ions form strong interactions with the hydroxyl groups of the sample molecules. The intensity of these interactions decreases in the sequence Pb > Ca > Na
- Recommended operating temperatures: 60–95 °C; maximum pressure 70 bar

Recommended application

- NUCLEOGEL® ION 300 OA: H⁺ form for separation of sugars, alcohols and organic acids
- NUCLEOGEL® SUGAR: Ca²⁺ form: separation of mono- and oligosaccharides, sugar alcohols
- Pb²⁺ form: separation of mono- and disaccharides from food and biological samples
- Na⁺ form: separation of oligosaccharides from starch hydrolysates and food

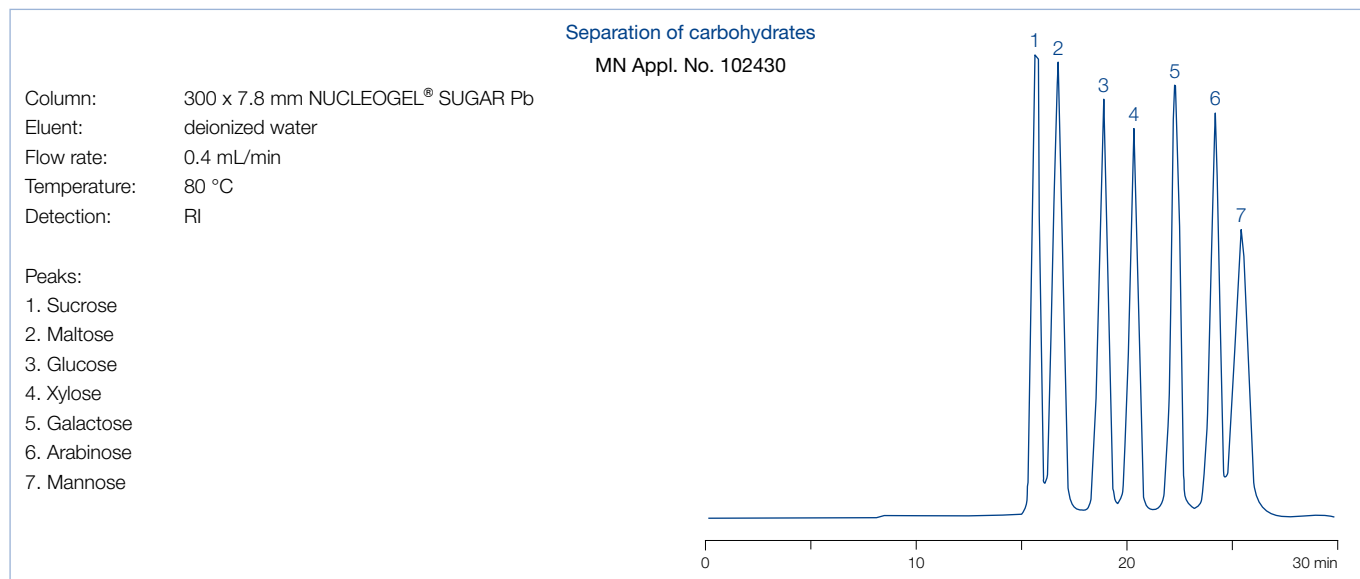

ID	Length → 300 mm	Guard columns*
NUCLEOGEL® ION 300 OA; eluent in column 5 mmol/L H ₂ SO ₄ 5 mmol/L H ₂ SO ₄		
Analytical Valco type columns		
7.8 mm	719501	719537
NUCLEOGEL® SUGAR Ca; eluent in column water + 0.02 % azide		
Analytical Valco type columns		
6.5 mm	719531	719535
NUCLEOGEL® SUGAR Pb; eluent in column water + 0.02 % azide		
Analytical Valco type columns		
7.8 mm	719530	719534
NUCLEOGEL® SUGAR Na; eluent in column water + 0.02 % azide		
Analytical Valco type columns		
7.8 mm	719532	719536

* Valco Type guard columns measure 21 × 4 mm and require the guard column holder C, REF 719538, see page 258. Columns in packs of 1, guard columns in packs of 2.



Columns for gel permeation chromatography



NUCLEOGEL® GPC for GPC of water-insoluble substances

Technical data

- Highly crosslinked macroporous, spherical polystyrene – divinylbenzene polymer matrix with good mechanical stability

Chromatogram of styrene oligomers

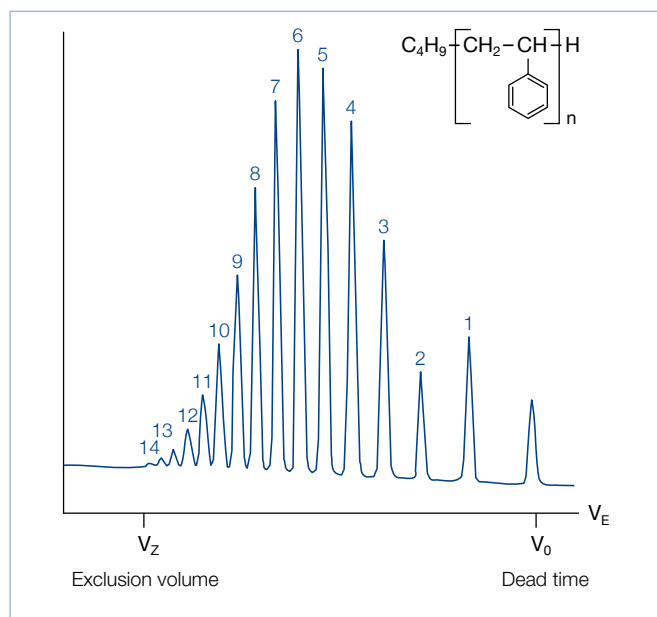

Working ranges for polystyrene

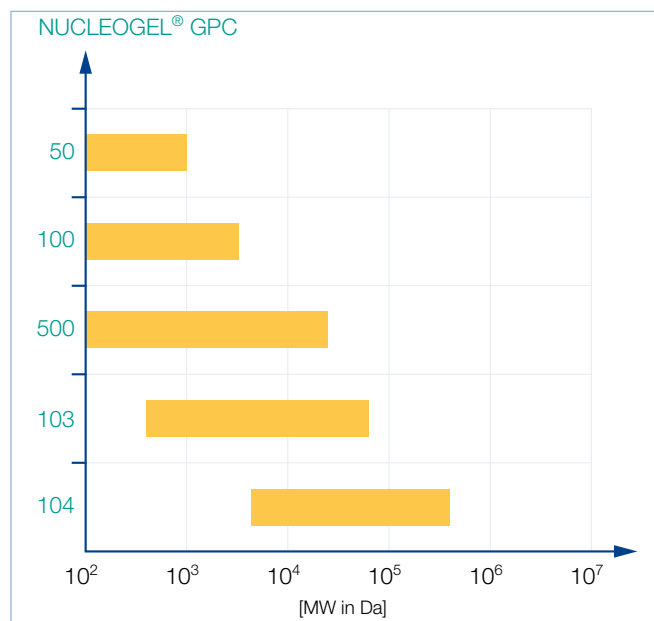

Eluent in column toluene

Phase	Exclusion limit [kDalton]	Application	Column 300 × 7.7 mm	
5 µm particle size				
Analytical Valco type columns				
	NUCLEOGEL® GPC 50	2	low molecular weight organics	719402
	NUCLEOGEL® GPC 100	4	oligomers, oils	719403
	NUCLEOGEL® GPC 500	25	low molecular weight polymers	719404
	NUCLEOGEL® GPC 103	60	low molecular weight polymers	719405
	NUCLEOGEL® GPC 104	500	polymers up to 500 kDa guard columns 50 × 7.7 mm	719406 719409
10 µm particle size				
Analytical Valco type columns				
	NUCLEOGEL® GPC 50	2	low molecular weight organics	719410
	NUCLEOGEL® GPC 100	4	oligomers, oils	719411
	NUCLEOGEL® GPC 500	25	low molecular weight polymers	719412
	NUCLEOGEL® GPC 103	60	low molecular weight polymers	719413
	NUCLEOGEL® GPC 104	500	polymers up to 500 kDa guard columns 50 × 7.7 mm	719414 719418

Columns and guard columns in packs of 1.

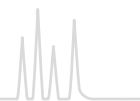

EC standard columns for analytical HPLC / UHPLC



- Analytical column system manufactured from stainless steel M8 outer threads on both ends combination of sealing element and very fine-meshed stainless steel screen, PTFE ring and fitting adaptor column heads SW 12, with inner threads M8 × 0.75 and UNF 10–32 (= 1/16" connection)
- EC column hardware guarantees pressure stability of 1200 bar - hereby EC columns are suitable for UHPLC applications (ultra fast HPLC) and all modern HPLC systems.
- As screw-on guard column system we recommend the Column Protection System used with EC guard column cartridges with 4 mm length.
- EC guard columns supplied with NUCLEODUR®, NUCLEOSIL® spherical silicas and NUCLEOSHELL® spherical core shell silica particles

Available standard dimensions of EC columns

ID	Length →									
	20 mm	30 mm	50 mm	75 mm	100 mm	125 mm	150 mm	200 mm	250 mm	300 mm
2 mm	+	+	+	+	+	+	+	+	+	+
3 mm	+	+	+	+	+	+	+	+	+	+
4 mm	+	+	+	+	+	+	+	+	+	+
4.6 mm	+	+	+	+	+	+	+	+	+	+

Please ask for availability of certain phases.

Note: NUCLEODUR® and NUCLEOSHELL® column head must not be removed!

Guard columns for EC columns

EC column with ID	EC guard column*
2 mm	4/2
3 mm	4/3
3 mm	4/3
3 mm	4/3

Packs of 3 cartridges

* Information about the Column Protection System on page 259.

For preparative applications MN offers the so-called VarioPrep® hardware system, which is described from page 260 on.

Valco type columns



- Analytical column system manufactured from stainless steel
- Available inner diameters: 4.6 mm ID (1/4" OD) and 7.7 mm (3/8" OD)
- Mainly used for NUCLEOGEN® and NUCLEOGEL® (see page 231)

Description	Pack of	REF
Accessories for Valco type columns		
Guard column holder B for VA columns 5 × 3 mm	1	719539
Guard column holder C for VA guard columns 21 × 4 mm	1	719538

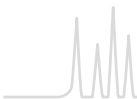

Column Protection System

Innovative and universal guard column holder system



- Suitable for all analytical HPLC columns with 1/16" fittings
- Cartridges filled with special NUCLEODUR®, NUCLEOSIL® and NUCLEOSHELL® HPLC adsorbents
- Ideal protection for your analytical main column
→ significant increase in column lifetime
- Minimized dead volume → suitable also for ultra-fast HPLC
- Special ferrules → pressure stability up to 1300 bar (18,850 psi)
- Visual contamination check
→ in-time changing of the guard column
- Suitable guard columns with 4 mm length, 2 mm ID (for main columns with 2 mm ID); 3 mm ID (for main columns with 3, 4 and 4.6 mm), respectively
- UNIVERSAL RP guard columns suitable for all HPLC columns under RP conditions

Content of the Column Protection System



Description	Pack of	REF
Guard column holder	1	
Capillaries (0.12 mm ID)	2	
Ferrules	3	718966
Wrenches	2	
Manual	1	

Description	Pack of	REF
Replacement parts for the Column Protection System		
Special ferrules made of PEEK	5	718967
Replacement connector including O-ring	1	718968
Stainless steel capillaries 0.12 mm ID, nuts and metal ferrules	3	718969
Stainless steel capillaries 0.18 mm ID (for higher flow rates), nuts and metal ferrules	3	718971
Wrench (size 12 and 14 mm)	1	718970
EC 4/2 UNIVERSAL RP guard column (for main columns with 2 mm ID)	3	728777.20
EC 4/2 UNIVERSAL RP guard column (for main columns with 2 mm ID), value pack	9	728778.20
EC 4/3 UNIVERSAL RP guard column (for main columns with 3, 4 and 4.6 mm ID)	3	728777.30
EC 4/3 UNIVERSAL RP guard column (for main columns with 3, 4 and 4.6 mm ID), value pack	9	728778.30

Visual contamination check

The cartridge is fitted with a special filter membrane:

- If this silver membrane is contaminated (bright or dark discoloration), it is advisable to replace the cartridge.
- If the contaminants are colorless, replace the cartridge if the pressure rises or the chromatographic performance decreases.

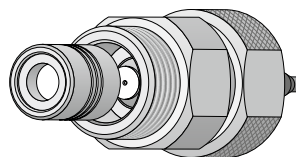

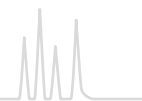

VarioPrep (VP) columns for preparative HPLC



- Column system for preparative HPLC, manufactured from stainless steel with two adjustable end fittings, suitable for frequent use of back-flushing techniques
- Allows compensation of a dead volume, which could occur at the column inlet after some time of operation, without need for opening the column
- Can be packed with all NUCLEODUR® and NUCLEOSIL® spherical silicas

Available standard dimensions of VarioPrep columns with axially adjustable end fittings

End fitting design	ID	Length →		Length →						
		10* mm	15* mm	50 mm	75 mm	100 mm	125 mm	150 mm	250 mm	500 mm
	8	+		+		+	+	+	+	
	10			+		+	+	+	+	
	16	+		+		+	+	+	+	
	21			+	+	+	+	+	+	
	32		+			+		+	+	
	40			+		+	+	+	+	+
	50		+			+		+	+	
	80								+	+

* 10 × 8, 10 × 16, 15 × 32 and 15 × 50 mm ID columns are used as guard columns and require the respective holders, see page 261.

The VarioPrep principle



VarioPrep columns are produced with highest packing quality and bed density (1). Due to intensive chemical and/or mechanical exposure of the column adsorbent, shrinking of the column bed can occur (2; orange gap). In this even unlikely case readjustment of the VarioPrep

column fitting (3; turning the nut at the column inlet clockwise) will eliminate the emerged dead volume (4). The performance of the VarioPrep column is completely reconstituted and column lifetime is significantly extended.

Column reconstitution

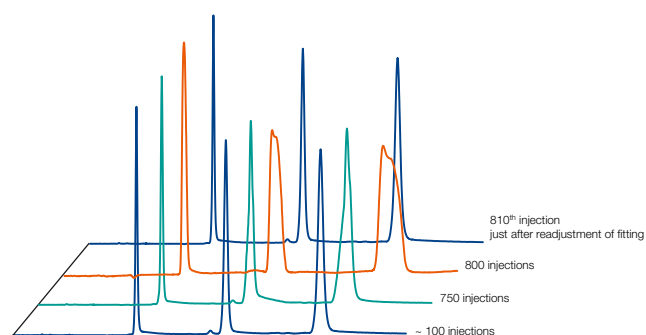

Reconstitution of VarioPrep column performance

- Slight peak broadening and deformation after 800 injections under strongly demanding conditions (pH 11; 50 °C; sample in DMSO)
- Readjustment of the column fitting restores column performance and prolongs column lifetime noticeably.

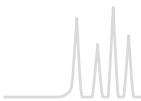

The improved guard column system for (semi-) preparative HPLC



- ① VP 15/32 for 32 and 40 mm ID columns ③ VP 10/8 for 8 and 10 mm ID columns
- ② VP 10/16 for 16 and 21 mm ID columns ④ VP 15/50 for ≥ 50 mm ID columns

- Easy handling and cartridge exchange
- Robust hardware
- Free rotary plunger fittings – low O-ring abrasion
- Cost-efficient cartridges
- Minimally invasive / no disturbance of the separation efficiency of main column
- Low back pressure
- Designed for pressures up to 400 bar

Column performance without and with guard column

Columns: 125 x 16 mm NUCLEODUR® C₁₈ HTec, 5 μ m
 125 x 16 mm NUCLEODUR® C₁₈ HTec, 5 μ m + 10 x 16 mm NUCLEODUR® C₁₈ HTec guard column

Eluent: acetonitrile – water (80:20, v/v)

Flow rate: 16 mL/min

Temperature: 22 °C

- Peaks:
1. Phenol
 2. Naphthalene
 3. Anthracene

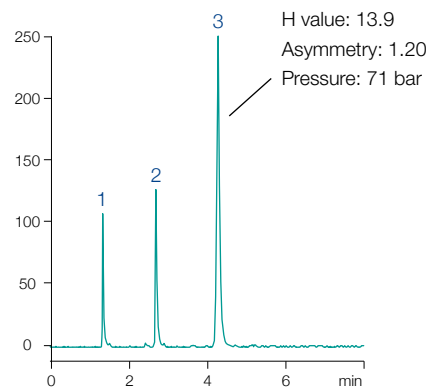
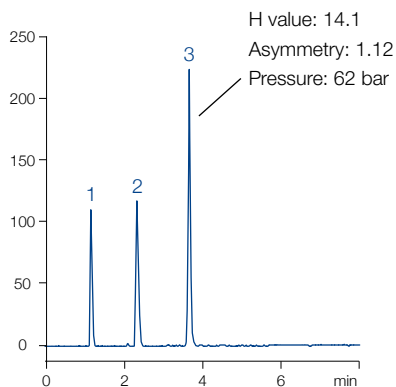

Using VarioPrep guard columns provides ideal protection of your main column – symmetry, pressure and retention stay almost constant.

Technical data

1/16" thread, free rotary plunger fittings, low O-ring abrasion, stainless steel

Guard cartridge	Holder REF	Holder ID	Recommended for column ID	Preferred capillary ID	Typical flow rate
VP 10/8	718251	8 mm	8 and 10 mm ID	0.17 and 0.25 mm	1 – 12 mL/min
VP 10/16	718256	16 mm	16 and 21 mm ID	0.17, 0.25 and 0.5 mm	2 – 32 mL/min
VP 15/32	718253	32 mm	32 and 40 mm ID	0.25, 0.5 and 1.0 mm	5 – 150 mL/min
VP 15/50	718255	50 mm	≥ 50 mm ID	0.5 and 1.0 mm	20 – 250 mL/min

Guard column holders for VarioPrep columns

VP Guard columns for VarioPrep columns with ID \rightarrow				Pack of guard columns	Replacement O-ring (pack of 2)	Holder ID	REF
8, 10 mm	16, 21 mm	32, 40 mm	≥ 50 mm				
VP 10/8				2	718975	8 mm	718251
VP	10/16			2	718976	16 mm	718256
VP		15/32		1	718977	32 mm	718253
VP			15/50	1	718978	50 mm	718255

For REF numbers of individual VP guard column cartridges see respective NUCLEODUR® and NUCLEOSIL® phases.

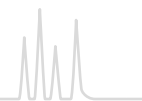

Accessories for stainless steel HPLC columns

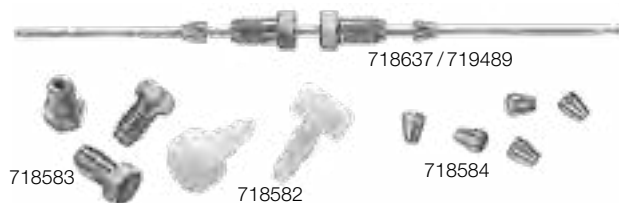

- Stainless steel columns are most frequently used in HPLC.
- The material is corrosion resistant, pressure stable and easy to work mechanically.

Description	Pack of	REF
Capillary accessories		
1/16" column end caps (plastic)	4	718582
1/16" nut for connecting 1/16" capillaries	5	718583
1/16" ferrule	5	718584
Capillary unions		
Typ 1: 100 mm x 1/16" x 0.25 mm	1	718637
Typ 2: 100 mm x 1/16" x 0.12 mm	1	719489
Cutter for 1/16" capillary tubing	1	706290

For accessories and replacement parts for EC columns see page 259, for accessories and replacement parts for VarioPrep columns see page 261.



SPE accessories for sample preparation, like e. g., CHROMABOND® vacuum manifolds can be found on page 66.



PEEK accessories

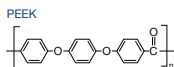

PEEK (= polyether ether ketone) is a high performance polymer belonging to the group of polyarylether ketones (PAEK), which meets all requirements of HPLC columns with respect to chemical resistance and mechanical stability. In some fields of application in HPLC like, e. g., in ion chromatography and chromatography of biopolymers, PEEK fulfills the requirements for a nonmetallic material.

All fittings can be tightened by hand.

Description	Pack of	REF
-------------	---------	-----

PEEK fittings		
1/16" PEEK fingertight fitting, 1-part combination nut + ferrule	1	718770
1/16" PEEK fingertight Nut	1	718771
1/16" PEEK ferrule for REF 718771	1	718772
1/16" PEEK double ferrule	1	718775



1/16" PEEK union, both sides inner threads, equipped with 2 fingertight nuts and double ferrules	1	718766
--	---	--------



1/16" PEEK union, both sides inner threads, however without nuts and without ferrules	1	718767
---	---	--------



1/16" PEEK union, both sides outer threads	1	718768
--	---	--------



AD	ID [mm]	Length	Pack of	REF
----	---------	--------	---------	-----

PEEK standard capillaries				
1/16"	0.13	1 m	1	718765
1/16"	0.17	1 m	1	718760
1/16"	0.25	1 m	1	718761
1/16"	0.5	1 m	1	718762
1/16"	0.75	1 m	1	718763

Description	Pack of	REF
-------------	---------	-----

Tools for PEEK capillaries		
Guillotine cutter for PEEK and PTFE capillaries	1	718769



Clean-Cut cutter for different capillary outer diameters	1	718755
--	---	--------



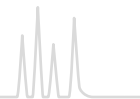

Basics of preparative HPLC

In principal for preparative HPLC the same rules apply than for analytic HPLC. However both differ significantly in their aim. The aim of analytic HPLC is a preferably complete separation of the single components of a mixture with subsequent peak identification. In contrast the goal of preparative HPLC is isolation of the desired product in defined purity, maximum amount while having a cost effective method of operating.

Demand of a preparative separation

- Throughput
- Purity
- Yield

Upscaling table for current MN column dimensions



ID x Length [mm]	4 x 250	8 x 250	10 x 250	16 x 250	21 x 250	32 x 250	40 x 250	50 x 250	80 x 250
Linear scale-up factor	1	4	6.25	16	27.6	64	100	156.3	400
Typical amount of sample* [mg]	0.02–2	0.08–8	0.13–13	0.3–35	0.6–60	1.3–130	2–210	3–350	10–850
Typical flow rate [mL/min]	0.5–1.5	2–6	3–9	8–24	14–40	32–96	50–150	80–250	200–600

* based on RP material; the herein stated maximum amounts of sample are dependent on the separation problem and the sample. In some cases half the maximum amount of sample can already lead to a drastic overload of the column, in other cases the maximum amount of sample still leads to an acceptable separation.

NUCLEODUR® bulk packings

- Fully spherical high purity silica
- Pore size 110 Å; pore volume 0.9 mL/g; surface (BET) 340 m²/g; density 0.47 g/mL; pressure stable up to 600 bar
- Bigger particles for preparative application

Phase	Endcapped	Carbon content	Particle size	Pack of 100 g
NUCLEODUR® C₁₈ HTec premium octadecyl phase (see page 178)				
NUCLEODUR® C ₁₈ HTec, 7 µm	yes	18 % C	7 µm	713831.0100
NUCLEODUR® C ₁₈ HTec, 10 µm	yes	18 % C	10 µm	713832.0100
NUCLEODUR® C₁₈ ec standard octadecyl phase (see page 181)				
NUCLEODUR® 100-10 C ₁₈ ec	yes	17.5 % C	10 µm	713611.0100
NUCLEODUR® 100-12 C ₁₈ ec	yes	17.5 % C	12 µm	713618.0100
NUCLEODUR® 100-16 C ₁₈ ec	yes	17.5 % C	16 µm	713621.0100
NUCLEODUR® 100-20 C ₁₈ ec	yes	17.5 % C	20 µm	713601.0100
NUCLEODUR® 100-30 C ₁₈ ec	yes	17.5 % C	30 µm	713631.0100
NUCLEODUR® 100-50 C ₁₈ ec	yes	17.5 % C	50 µm	713550.0100
Unmodified NUCLEODUR® SiOH silica (see page 190)				
NUCLEODUR® 100-10			10 µm	713610.0100
NUCLEODUR® 100-12			12 µm	713615.0100
NUCLEODUR® 100-16			16 µm	713620.0100
NUCLEODUR® 100-20			20 µm	713600.0100
NUCLEODUR® 100-30			30 µm	713630.0100
NUCLEODUR® 100-50			50 µm	713551.0100



POLYGOSIL[®] bulk packings

- Irregular silica for analytical applications
- pH stability 2 – 8

Physical properties of unmodified POLYGOSIL[®] materials

Phase	Pore size	Pore volume	Surface (BET)	Density	Pressure stability
POLYGOSIL [®] 60	60 Å	0.75 mL/g	350 m ² /g	0.45 g/mL	600 bar
POLYGOSIL [®] 100	100 Å	1 mL/g	280 m ² /g	0.35 g/mL	400 bar
POLYGOSIL [®] 300	300 Å	0.8 mL/g	100 m ² /g	0.45 g/mL	400 bar
POLYGOSIL [®] 1000	1000 Å	0.8 mL/g	25 m ² /g	0.45 g/mL	300 bar

Modification of POLYGOSIL[®] follows the same processes as for NUCLEOSIL[®] silica.

Phase	Endcapped	Carbon content	Pore size	Particle size	Pack of 10 g	Pack of 100 g
Octadecyl phases – (CH₂)₁₇ – CH₃						
POLYGOSIL [®] 60-5 C ₁₈	yes	12 % C	60 Å	5 µm	711330.10	711330.100
POLYGOSIL [®] 60-7 C ₁₈	yes	12 % C	60 Å	7 µm	711340.10	711340.100
POLYGOSIL [®] 60-10 C ₁₈	yes	12 % C	60 Å	10 µm	711350.10	711350.100
POLYGOSIL [®] 100-5 C ₁₈	yes	14 % C	100 Å	5 µm	711560.10	711560.100
POLYGOSIL [®] 100-7 C ₁₈	yes	14 % C	100 Å	7 µm	711570.10	711570.100
POLYGOSIL [®] 100-10 C ₁₈	yes	14 % C	100 Å	10 µm	711580.10	711580.100
POLYGOSIL [®] 300-7 C ₁₈	yes	4 % C	300 Å	7 µm	711710.10	711710.100
POLYGOSIL [®] 1000-7 C ₁₈	yes	~ 1 % C	1000 Å	7 µm	711992.10	711992.100
Octyl phases – (CH₂)₇ – CH₃						
POLYGOSIL [®] 60-5 C ₈	no	7 % C	60 Å	5 µm	711300.10	711300.100
POLYGOSIL [®] 60-7 C ₈	no	7 % C	60 Å	7 µm	711310.10	711310.100
POLYGOSIL [®] 60-10 C ₈	no	7 % C	60 Å	10 µm	711320.10	711320.100
Butyl phases – (CH₂)₃ – CH₃						
POLYGOSIL [®] 300-7 C ₄	yes	~ 1 % C	300 Å	7 µm	711680.10	711680.100
POLYGOSIL [®] 1000-7 C ₄	yes	< 1 % C	1000 Å	7 µm	711991.10	711991.100
Cyano phases (nitrile) – (CH₂)₃ – CN						
POLYGOSIL [®] 60-5 CN		~ 5 % C	60 Å	5 µm	711380.10	711380.100
POLYGOSIL [®] 60-10 CN		~ 5 % C	60 Å	10 µm	711390.10	711390.100
Amino phases – (CH₂)₃ – NH₂						
POLYGOSIL [®] 60-5 NH ₂		~ 3 % C	60 Å	5 µm	711360.10	711360.100
POLYGOSIL [®] 60-10 NH ₂		~ 3 % C	60 Å	10 µm	711370.10	711370.100
Dimethylamino phases – (CH₂)₃ – N(CH₃)₂						
POLYGOSIL [®] 60-5 N(CH ₃) ₂		~ 3.5 % C	60 Å	5 µm	711420.10	711420.100
POLYGOSIL [®] 60-10 N(CH ₃) ₂		~ 3.5 % C	60 Å	10 µm	711430.10	711430.100
Unmodified silica; SiOH						
POLYGOSIL [®] 60-5			60 Å	5 µm	711010.10	711010.100
POLYGOSIL [®] 60-7			60 Å	7 µm	711280.10	711280.100
POLYGOSIL [®] 60-10			60 Å	10 µm	711020.10	711020.100
POLYGOSIL [®] 100-5			100 Å	5 µm	711510.10	711510.100
POLYGOSIL [®] 100-7			100 Å	7 µm	711520.10	711520.100
POLYGOSIL [®] 100-10			100 Å	10 µm	711530.10	711530.100
POLYGOSIL [®] 300-7			300 Å	7 µm	711600.10	711600.100
POLYGOSIL [®] 1000-7			1000 Å	7 µm	711890.10	711890.100

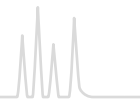

POLYGOPREP bulk packings

- Irregular silica for preparative applications
- pH stability 2–8

Physical properties of unmodified POLYGOPREP materials

Phase	Pore size	Pore volume	Surface (BET)	Density	Pressure stability
POLYGOPREP 60	60 Å	0.75 mL/g	350 m ² /g	0.45 g/mL	600 bar
POLYGOPREP 100	100 Å	1 mL/g	280 m ² /g	0.35 g/mL	400 bar
POLYGOPREP 300	300 Å	0.8 mL/g	100 m ² /g	0.45 g/mL	400 bar
POLYGOPREP 1000	1000 Å	0.8 mL/g	35 m ² /g	0.45 g/mL	300 bar

Modification of POLYGOPREP follows the same processes as for NUCLEOSIL® silica.

Phase	Endcapped	Carbon content	Pore size	Particle size	Pack of 100 g	Pack of 1 kg
Octadecyl phases – (CH₂)₁₇ – CH₃						
POLYGOPREP 60-12 C ₁₈	no*	12 % C	60 Å	10–15 µm	711009.100	711009.1000
POLYGOPREP 60-20 C ₁₈	no*	12 % C	60 Å	15–25 µm	711031.100	711031.1000
POLYGOPREP 60-30 C ₁₈	no*	12 % C	60 Å	25–40 µm	711480.100	711480.1000
POLYGOPREP 60-50 C ₁₈	no*	12 % C	60 Å	40–63 µm	711500.100	711500.1000
POLYGOPREP 60-80 C ₁₈	no*	12 % C	60 Å	63–100 µm	711011.100	711011.1000
POLYGOPREP 60-130 C ₁₈	no*	12 % C	60 Å	63–200 µm	711590.100	711590.1000
POLYGOPREP 100-12 C ₁₈	no*	14 % C	100 Å	10–15 µm	711018.100	711018.1000
POLYGOPREP 100-20 C ₁₈	no*	14 % C	100 Å	15–25 µm	711019.100	711019.1000
POLYGOPREP 100-30 C ₁₈	no*	14 % C	100 Å	25–40 µm	711032.100	711032.1000
POLYGOPREP 100-50 C ₁₈	no*	14 % C	100 Å	40–63 µm	711021.100	711021.1000
POLYGOPREP 300-12 C ₁₈	yes	4 % C	300 Å	10–15 µm	711024.100	711024.1000
POLYGOPREP 300-20 C ₁₈	yes	4 % C	300 Å	15–25 µm	711025.100	711025.1000
POLYGOPREP 300-30 C ₁₈	yes	4 % C	300 Å	25–40 µm	711720.100	711720.1000
POLYGOPREP 300-50 C ₁₈	yes	4 % C	300 Å	40–63 µm	711730.100	711730.1000
POLYGOPREP 1000-30 C ₁₈	yes	~ 1 % C	1000 Å	25–40 µm	711028.100	711028.1000
POLYGOPREP 1000-50 C ₁₈	yes	~ 1 % C	1000 Å	40–63 µm	711029.100	711029.1000
Octyl phases – (CH₂)₇ – CH₃						
POLYGOPREP 60-12 C ₈	no*	7 % C	60 Å	10–15 µm	711007.100	711007.1000
POLYGOPREP 60-20 C ₈	no*	7 % C	60 Å	15–25 µm	711008.100	711008.1000
POLYGOPREP 60-30 C ₈	no*	7 % C	60 Å	25–40 µm	711470.100	711470.1000
POLYGOPREP 60-50 C ₈	no*	7 % C	60 Å	40–63 µm	711490.100	711490.1000
* On request, these POLYGOPREP RP phases can be endcapped at surcharge.						
Butyl phases – (CH₂)₃ – CH₃						
POLYGOPREP 300-12 C ₄	yes	~ 1 % C	300 Å	10–15 µm	711022.100	711022.1000
POLYGOPREP 300-20 C ₄	yes	~ 1 % C	300 Å	15–25 µm	711023.100	711023.1000
POLYGOPREP 300-30 C ₄	yes	~ 1 % C	300 Å	25–40 µm	711690.100	711690.1000
POLYGOPREP 300-50 C ₄	yes	~ 1 % C	300 Å	40–63 µm	711700.100	711700.1000
POLYGOPREP 1000-30 C ₄	yes	< 1 % C	1000 Å	25–40 µm	711026.100	711026.1000
POLYGOPREP 1000-50 C ₄	yes	< 1 % C	1000 Å	40–63 µm	711027.100	711027.1000
Cyano phases (nitrile) – (CH₂)₃ – CN						
POLYGOPREP 60-12 CN		~ 4.5 % C	60 Å	10–15 µm	711015.100	711015.1000
POLYGOPREP 60-20 CN		~ 4.5 % C	60 Å	15–25 µm	711016.100	711016.1000
POLYGOPREP 60-30 CN		~ 4.5 % C	60 Å	25–40 µm	711017.100	711017.1000
Amino phases – (CH₂)₃ – NH₂						
POLYGOPREP 60-12 NH ₂		~ 3 % C	60 Å	10–15 µm	711012.100	711012.1000
POLYGOPREP 60-20 NH ₂		~ 3 % C	60 Å	15–25 µm	711013.100	711013.1000
POLYGOPREP 60-30 NH ₂		~ 3 % C	60 Å	25–40 µm	711014.100	711014.1000



POLYGOPREP irregular silica for HPLC



Phase	Pore size	Particle size	Pack of 100 g	Pack of 1 kg
Unmodified POLYGOPREP silica; SiOH				
POLYGOPREP 60-12	60 Å	10–15 µm		711001.1000
POLYGOPREP 60-20	60 Å	15–25 µm		711240.1000
POLYGOPREP 60-30	60 Å	25–40 µm		711250.1000
POLYGOPREP 60-50	60 Å	40–63 µm		711260.1000
POLYGOPREP 60-80	60 Å	63–100 µm		711270.1000
POLYGOPREP 60-130	60 Å	63–200 µm		711037.1000
POLYGOPREP 100-12	100 Å	10–15 µm		711002.1000
POLYGOPREP 100-20	100 Å	15–25 µm		711003.1000
POLYGOPREP 100-30	100 Å	25–40 µm		711540.1000
POLYGOPREP 100-50	100 Å	40–63 µm		711550.1000
POLYGOPREP 100-80	100 Å	63–100 µm		711033.1000
POLYGOPREP 100-130	100 Å	63–200 µm		711034.1000
POLYGOPREP 300-12	300 Å	10–15 µm	711004.100	711004.1000
POLYGOPREP 300-20	300 Å	15–25 µm		711610.1000
POLYGOPREP 300-30	300 Å	25–40 µm	711620.100	711620.1000
POLYGOPREP 300-50	300 Å	40–63 µm	711630.100	711630.1000
POLYGOPREP 1000-12	1000 Å	10–15 µm	711035.100	711035.1000
POLYGOPREP 1000-20	1000 Å	15–25 µm		711036.1000
POLYGOPREP 1000-30	1000 Å	25–40 µm	711005.100	711005.1000
POLYGOPREP 1000-50	1000 Å	40–63 µm	711006.100	711006.1000

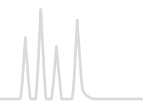

Silica adsorbents for low pressure column chromatography



- Silica 60; pore size ~ 60 Å; pore volume ~ 0.75 mL/g; spec. surface BET ~ 500 m²/g highly porous, amorphous silicic acid in the form of hard, opalescent particles, prepared by precipitation of water glass with sulfuric acid
- For higher demands on the performance of column packings we recommend our high-purity irregular POLYGOPREP silicas (see before).
- Silica FIA for the fluorescence indicator adsorption procedure for the determination of hydrocarbon groups in the testing of liquid fuels in accordance with DIN 51791 and ASTM D 1319-58T
- The FIA method determines saturated hydrocarbons, olefins and aromatic hydrocarbons of a sample chromatographically by adsorption and desorption in a column filled with FIA silica, in the presence of a fluorescent dye mixture.

Description	Particle size	1 kg	5 kg	25 kg
Silica 60, 0.015–0.04 mm	–	815650.1	815650.5	815650.25
Silica 60, 0.025–0.04 mm	–	815300.1	815300.5	815300.25
Silica 60, 0.04–0.063 mm	230–400 mesh	815380.1	815380.5	815380.25
Silica 60 M, 0.04–0.063 mm	230–400 mesh	815381.1	815381.5	815381.25
Silica 60, 0.05–0.1 mm	130–270 mesh	815390.1	815390.5	815390.25
Silica 60, 0.05–0.2 mm	70–270 mesh	815320.1	815320.5	815320.25
Silica 60, 0.063–0.2 mm	70–230 mesh	815330.1	815330.5	815330.25
Silica 60, < 0.063 mm	+230 mesh	815400.1	815400.5	815400.25
Silica 60, < 0.08 mm	+190 mesh	815310.1	815310.5	815310.25
Silica 60, 0.1–0.2 mm	70–130 mesh	815340.1	815340.5	815340.25
Silica 60, 0.2–0.5 mm	35–70 mesh	815350.1	815350.5	815350.25
Silica 60, 0.5–1.0 mm	18–35 mesh	815360.1	815360.5	815360.25
Silica FIA fine	0.071–0.16 mm	815410.1		
Silica FIA coarse	0.071–0.63 mm	815430.1		

Aluminum oxide

- Aluminum oxides produced by dehydration of different aluminum hydroxides, e. g., hydrargillite between 400 and 500 °C.
- Activity grade I, particle size 50–200 µm, specific surface (BET) ~ 130 m²/g

Description	pH	1 kg	5 kg	25 kg
Aluminum oxide 90 basic	pH 9.5 ± 0.3	815010.1	815010.5	815010.25
Aluminum oxide 90 neutral	pH 7 ± 0.5	815020.1	815020.5	815020.25
Aluminum oxide 90 acidic	pH 4 ± 0.3	815030.1	815030.5	815030.25

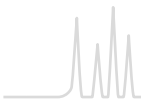

Adsorbents for column chromatography



Kieselguhr

- Naturally occurring amorphous silicic acids of fossil origin, also known as diatomaceous earth or diatomite purified for chromatographic applications
- Compared to silica, kieselguhr has a small surface of low activity → application in partition chromatography; impregnated with various substances (paraffin, silicone oil, undecane) it can be used for reversed phase chromatography
- The following grades of kieselguhr are manufactured by Johns-Manville. They are narrowly classified with homogeneous particle size distributions and high purity.
- For columns packed with kieselguhr please see CHROMABOND® XTR for liquid-liquid extraction, page 64.

Description	Rel. purification factor	Rel. flow rate	1 kg	5 kg
Filter-Cel®	100	100	815510.1	815510.5
Celite® 503	42	910	815540.1	815540.5
Celite® 535	35	1269	815550.1	815550.5
Celite® 545	32	1830	815560.1	815560.5

Florisil®

- Hard granular magnesia silica gel:
MgO 15.5 ± 0.5 % · SiO₂ 84.0 ± 0.5 % · Na₂SO₄ ≤ 1.0 %;
60/100 mesh
- Recommended application
Sample preparation (see chapter “Solid phase extraction”, page 8)
- Clean-up of pesticide residues, separation of chlorinated pesticides, extraction of steroids, sex hormones, antibiotics, lipids etc.

Description	Particle size	1 kg	5 kg
Florisil standard 60/100 mesh	0.15/0.25 mm	815710.1	815710.5

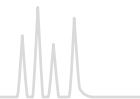

Polyamide

- Polyamide 6 = ϵ -polycaprolactam
- The separation mechanism mainly based on hydrogen bonds
- Recommended application
Separation of phenolic compounds (e. g., isolation of natural products) carboxylic acids, aromatic nitro compounds
- For SPE columns packed with polyamide see CHROMABOND® PA page 43.

Description	Particle size	1 kg	5 kg
Polyamide SC 6, < 0.07 mm	< 0,07 mm	815610.1	815610.5
Polyamide SC 6, 0.05–0.16 mm	0.05–0.16 mm	815620.1	815620.5
Polyamide SC 6, 0.10–0.30 mm	0.10–0.30 mm	815600.1	815600.5

Unmodified cellulose

- Cellulose MN 100:
native fibrous cellulose, standard grade average degree of polymerization 620–680, fiber length (85 %) 20–100 μm , specific surface acc. to Blaine ~ 6,500 cm^2/g ; residue on ignition at 850 °C < 10,000 ppm, < 20 ppm Fe, < 5 ppm Cu, < 7 ppm P, CH_2Cl_2 extract < 0.20 %
- Cellulose MN 2100:
native fibrous cellulose, purified grade (washed with different eluents) average degree of polymerization 620–680, fiber length (85 %) 20–75 μm , specific surface acc. to Blaine ~ 5,500 cm^2/g residue on ignition at 850 °C < 1,000 ppm, < 2 ppm Fe, < 1 ppm Cu, < 2 ppm P, CH_2Cl_2 extract < 0.15 %
- Grade MN 2100ff is a defatted cellulose MN 2100 with a CH_2Cl_2 extract < 0.02 %

Description	1 kg	5 kg	25 kg
Cellulose MN 100	815050.1	815050.5	815050.25
Cellulose MN 2100	815060.1	815060.5	815060.25
Cellulose MN 2100ff (Cellulose MN 2100 defatted)	815070.1		



MACHEREY-NAGEL

optimal autosampler vials for your sample

Vials and closures

For reliable and reproducible analysis the correct storage of sample solutions is important. MACHEREY-NAGEL offers diverse vials and suitable closures.

Our product range includes

- Different vial types from N 8 to N 24
 - Crimp neck
 - Screw neck
 - Snap ring
- Clear glass, amber glass and polypropylene vials, with or without scale and label
- Diverse inserts for small sample volumes
- Variety of closures and septa of different material
- Suitable accessories like crimping tools and vial containers
- Compatibility with different autosamplers from page 136 onwards



Our broad range of vials and closures can be found from page 102 onwards.

Also use our VialFinder on www.mn-net.com/VialFinder



Thin layer chromatography

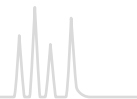

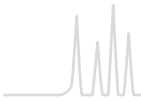

Contents

Basics.....	274
Introductory kits.....	277
Summary of MN ready-to-use layers.....	280
Unmodified TLC silica layers.....	282
Silica layers with concentrating zone.....	286
Unmodified HPTLC silica layers.....	288
Modified silica layers.....	291
Further layers.....	296
Layers for special TLC separations.....	299
Chromatography papers.....	302
Accessories.....	303
Reagents.....	304
Adsorbents.....	305



Glass plates



ALUGRAM® Xtra aluminum sheets
ALUGRAM® aluminum sheets



POLYGRAM® polyester sheets

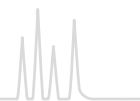

Thin layer chromatography (TLC) and high performance thin layer chromatography (HPTLC), also called planar chromatography, are, like all chromatographic techniques, based on a multi-stage distribution process involving

- Suitable adsorbents (the stationary phase) coated as a thin layer onto a suitable support (e.g., glass plate, polyester or aluminum sheet; also see page 280)
- Solvents or solvent mixtures (the mobile phase or eluent)
- Sample molecules

Features of modern TLC/HPTLC

The success of thin layer chromatography as a highly efficient microanalytical separation method is based on a large number of advantageous properties:

- High sample throughput in a short time
- Suitable for screening tests
- Pilot procedure for HPLC and Flash chromatography

Principle steps of a TLC separation

Sample preparation

For separation the sample must meet several requirements to obtain good results. Since the TLC plate is a disposable product, sample preparation in general is not as demanding as for other chromatographic methods. However, eventually several steps for sample pretreatment may be necessary. These include sampling, mechanical crushing, extraction steps, filtration and sometimes enrichment of interesting components or clean-up, i.e. removal of undesired impurities.

Our TLC micro-sets introduce some simple methods of sample pretreatment. The dyes or dye mixtures of the beginner's set do not require complicated procedures. The advanced sets require the user to carry out some additional steps for preparing a sample, thus introducing the user to techniques often performed in industrial laboratories.

Thorough preparation of samples is an important prerequisite for the success of a TLC separation. For our range of products for more demanding sample pretreatment please see the chapter "SPE" from page 10.

Sample application

The most frequent technique is application with a glass capillary as spot or short streak.

Application as streak will yield better results especially for instrumental quantification. For both types of application some manual skill is required to obtain reproducible results. Substance zones which are too large from the beginning will cause poor separation since during chromatography they will become even larger and more diffuse.

The principle of TLC is known for more than 100 years [11]. The real break-through as an analytical method, however, came about 50 years ago as a consequence of the pioneering work of Egon Stahl [12].

Today TLC has gained increasing importance as an analytical separation technique, which is probably due to effects of instrumentation and automation [13]. At the same time the applicability of thin layer chromatography was enhanced by development of new adsorbents and supports.

Today MACHEREY-NAGEL offers a versatile range of ready-to-use layers, which are the result of 50 years of continuous research and development.

- After separation the analytical information can be stored for a longer period of time (the TLC ready-to-use layer acts as storage medium for data)
- Separated substances can be subjected to subsequent analytical procedures (e.g., IR, MS) at a later date
- Rapid and cost-efficient optimization of the separation due to easy change of mobile and stationary phase

A valuable aid for manual application especially of large volumes of very dilute samples is the concentrating zone (e.g., SILGUR-25 UV₂₅₄), which consists of a chromatographically inactive adsorbent (kieselguhr). The substances to be separated are concentrated to a small band in the concentrating zone and the separation starts at the beginning of the chromatographically active adsorbent silica.

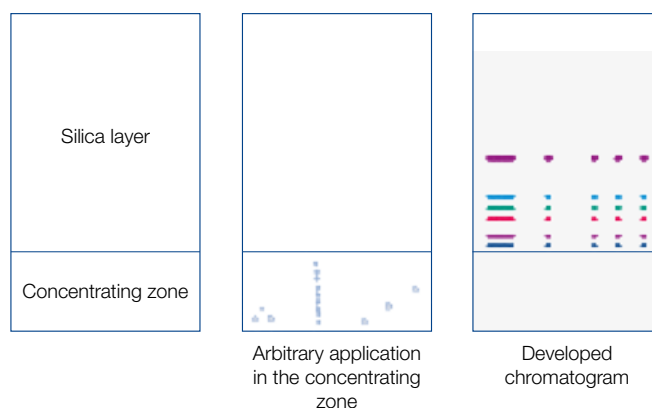

Another method for sample concentration is a short pre-elution (few mm) with a solvent, in which all substances have a high R_f value.

If a quantitative evaluation with a TLC scanner is to follow the separation we recommend to use commercially available sample applicators for spotting. These range from simple spotting guides via nanoapplicators to completely automated spotting

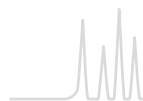

devices. Application as streak can be performed automatically by spraying of the sample without touching the layer of the TLC plate. Application as band over the whole width of the TLC plate is especially important for preparative TLC. After application allow the solvent of the samples to evaporate completely (about 10 min) or blow with cold or hot air. Development of a chromatogram should never start before the solvent of the applied samples is evaporated completely.

Developing a chromatogram – separation techniques

The most frequently used separation technique is ascending TLC in a trough chamber (standard method, linear development). Usually it is applied as single development. However, multiple development, with or without change of eluent (step technique) can improve separation results. For 2-dimensional development only 1 spot of the sample is applied in one edge of a plate. After chromatography in the first direction the plate is dried, turned by 90° and developed in the 2nd dimension with another eluent. Thus complicated mixtures give 2-dimensional chromatograms taking advantage of the different separating properties of two eluents.

For selection and optimization of the eluent numerous publications are available. A generally applicable standardized optimization method is described by H. Keuker et al. [14].

It is important to pay attention to the atmosphere in the developing chamber. If reproducible migration distances are required, saturation of the chamber atmosphere with eluent vapor is necessary. For this purpose the developing chamber is lined with well absorbing chromatography paper (e.g., MN 260) and charged with a correspondingly larger volume of eluent.

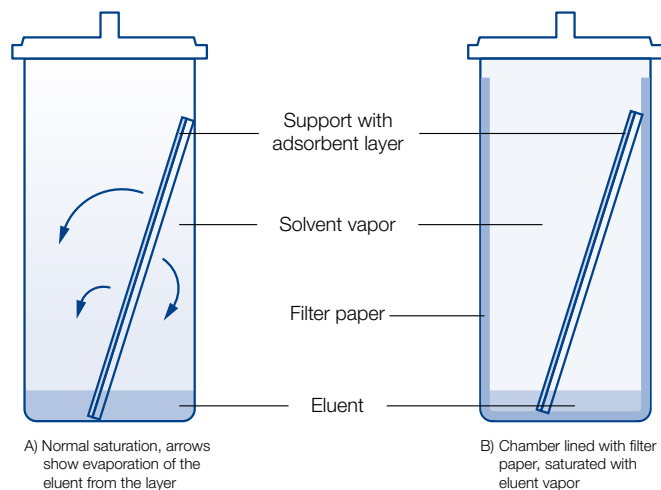

Evaluation of a thin layer chromatogram

Evaluation depends on the purpose of the chromatographic analysis. For qualitative determination often localization of substances is sufficient. This can be easily achieved by parallel runs with reference substances.

A parameter often used for qualitative evaluation is the R_f value (retention factor) or the 100-fold value hR_f . The R_f value is defined as follows:

$$R_f = \frac{\text{distance starting line - middle of spot}}{\text{distance starting line - solvent front}} = \frac{b}{a}$$

i.e. the R_f values are between 0 and 1, best between 0.1 and 0.8 (i.e. 10–80 for hR_f). If reproducible R_f values are to be obtained, it is essential that several parameters such as chamber saturation, composition of solvent mixtures, temperature etc. are strictly controlled.

Quantitative evaluation is possible by suitable calibration measurements. For this purpose either the area of a substance spot is measured or a photometric evaluation is performed directly on the layer. The latter procedure, however, requires a higher instrumental expense.

The following paragraphs describe the most frequently used methods for evaluation in TLC.

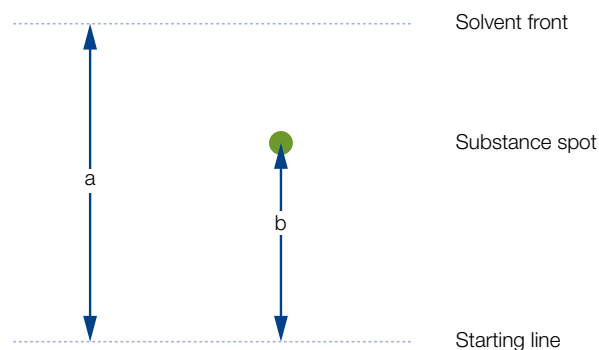

Qualitative detection

Qualitative evaluation is generally made directly on the TLC plate via characteristic R_f values of substances, i.e. the ratio of distance start – substance zone to distance start – solvent front and specific chemical reactions.

Visualization of separated substances

First of all it is necessary to recognize the position of a substance spot. Only in very few cases the sample is a dye which can be seen with the naked eye. Much more often for unspecific visualization substances can be viewed under UV light, since many substances show a UV absorption. If a fluorescent indicator is added to the layer, all substances absorbing in the respective region of wave length cause a quenching of the fluorescence, i.e. they appear as dark spots on the fluorescent layer. Customary fluorescent indicators are excited at 254 nm or (less frequently) at 366 nm with a mercury lamp. For our program of fluorescent indicators for TLC please see page 304.



Quenching of the fluorescence

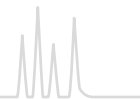

Identification of separated substances is possible via the R_f value compared to the pure compound, which is often applied simultaneously on the same plate.

For a number of compounds their native fluorescence can be used for visualization, which is excited by UV light (mostly long-wave UV) (e.g., aflatoxins). This allows not only determination of the R_f value, but often enables a further qualitative assignment.

If these methods do not allow localization or characterization of a substance, post-chromatographic detection methods can be applied, chemical reactions on the TLC plate [15]. Quite unspecific reactions are iodine adsorption and the charring technique (spraying with sulfuric acid and heat treatment).

More reliable results are possible with specific reagents for spraying or dipping, which form colored or fluorescent compounds with the substances to be detected. Depending on the sensitivity of these reactions they are not only used for group or substance specific characterization (in addition to the R_f value) but also for quantification down to trace levels. As example take the ninhydrin reaction. Formation of a (usually red) zone with this detection method yields the information, that a certain group of substances, e.g., α -amino acids, are present. The R_f value allows further assignment to one or several single compounds.

For identification of a substance a combination of different detection methods can be useful. Thus almost all lipids can be converted to products with light green fluorescence by reaction with 2',7'-dichlorofluorescein. Adsorption of iodine vapor enables a differentiation between saturated and unsaturated lipids or lipids containing nitrogen. And finally the R_f value is a third means of identification.

Here are some general remarks concerning spraying: use all spray reagents under a fume hood. The developed, dried TLC plate or sheet is placed on a sheet of filter paper for spraying. Usually it is sufficient to fill the sprayer with about 5–10 mL solution. Spray from a distance of about 15 cm with the aid of a rubber ball or – if available – with pressurized air. It is always better to spray a layer twice very thinly and evenly (with intermediate drying), than to saturate the layer with excessive spray reagent. In the latter case spots tend to become diffuse. After visualization mark outlines of zones with a lead pencil, because some spots tend to fade after a while.

Especially for quantitative evaluation short dipping of the layer in the respective reagent solution is recommended. For this purpose automatic instruments are commercially available, which allow reproducible dipping.

When a substance is localized on the TLC plate (e.g., under UV), but not yet identified, TLC scanners allow recording of UV spectra of individual substance zones directly on the layer, or the zone is removed by scratching or cutting (for sheets), eluted and further analyzed, e.g., by FT-IR, RAMAN, NMR or mass spectroscopy.

Quantitative evaluation

Often TLC is considered to be only a semiquantitative analytical procedure. This is true for visual evaluation of spots, since the eye can only compare but not measure absolute values. If, however, a direct optical evaluation (“in situ” measurement) is performed on the TLC plate with a thin layer scanner, after measurement of calibration functions, exact quantitative results are possible. Commercial scanners offer many features such as evaluation in absorption and fluorescence, unattended programmed scanning of lanes, multi-wave length measurement, background correction, selectable base line for integration, recording of spectra, evaluation of circular or anti-circular chromatograms with very high ease of operation. In addition to manual operation control by a computer is possible with respective data collection and storage. Usually wavelengths from 200 to 700 nm are available (visible and UV), e.g., all post-chromatographic (and of course all pre-chromatographic) visualization procedures are evaluated with the proper wavelength, which is determined with the instrument. Time requirements for all these possibilities are extremely low. Interlaboratory experiments with standard deviations of 2 % show how excellent results are obtainable [16].



TLC micro-sets introductory kits for science education

Beginner's set

- Features separations with simple developing solvents; samples are colored thus eliminating the need for visualization.
- All equipment needed is contained in the set.

TLC micro-set A for beginners

This kit contains all chemicals and accessories for the following separations:

- Separation of the fat-soluble (lipophilic)
Test dye mixture 1: butter yellow, indophenol, sudan blue II, sudan red G
- Separation of a mixture of anthraquinone dyes
Test dye mixture 2: blue 1, blue 3, green, green blue, red, violet 1, violet 2
- Separation of a mixture of food dyes
Test dye mixture 3: brilliant black BN (E151), fast red E, erythrosine (E127), yellow orange S (sunset yellow CFC, E110), naphthol red S, ponceau 4 R (E124), tartrazine (E102)
- Separation of dyes from felt tip pens

Advanced sets F1, F2 and F3

- Require some experience and skill from the user: some of the samples have to be pretreated before separation, and for identification of substances spray reagents have to be used

Contents of TLC micro-set A for beginners

1 manual
3 developing chambers
50 glass capillaries 1 μ L
1 spotting guide
2 felt tip pens
1 measuring cylinder 10 mL
50 polyester sheets 4 \times 8 cm each of POLYGRAM[®]: SIL G/UV₂₅₄, Alox N/UV₂₅₄ and CEL 300
8 mL each of test dye mixture 1 (4 lipophilic dyes), test dyes sudan red G, and sudan blue II
8 mL each of test dye mixture 2 (7 anthraquinone dyes), test dyes blue 1 and violet 2
8 mL each of test dye mixture 3 (7 food dyes), test dyes yellow orange S, and brilliant black BN
100 mL each of toluene, toluene – cyclohexane (2:1, v/v), ethanol, 2.5 % sodium citrate solution, 25 % ammonia solution – 2-propanol (5:3, v/v)

Designation	Pack of	REF
TLC micro-set A for beginners*	1 kit	814000
Replacement parts for TLC micro-set A		
Test dye mixture 1*, solution of 4 lipophilic dyes in toluene (components see above)	8 mL	814001
Test dye mixture 2*, solution of 7 anthraquinone dyes in toluene – cyclohexane (2:1, v/v) (components see above)	8 mL	814002
Test dye mixture 3, aqueous solution of 7 food dyes (components see above)	8 mL	814003
Collection of 4 individual components of test dye mixture 1*	4 \times 8 mL	814011
Collection of 7 individual components of test dye mixture 2*	7 \times 8 mL	814012
Collection of 7 individual components of test dye mixture 3	7 \times 8 mL	814013
Sodium citrate, 2.5 g in 100 mL bottle to fill up with distilled water	2.5 g	814029

* These products contain harmful substances which must be specially labeled as hazardous. For detailed information please see SDS.

Information about the advanced sets F1, F2 and F3 can be found on page 278 and page 279.

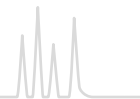

TLC micro-set F1

This kit contains all chemicals required for the separation of

- Amino acids (test mixture, consisting of alanine, arginine, tryptophan and valine)
- Amino acids in urine
- The heavy metal cations copper(II) and manganese(II)

TLC micro-set F2

This kit contains all chemicals required

- For analysis of edible fats
- For analysis of fats and cholesterol in blood

TLC micro-set F3

This kit contains all chemicals required

- For separation of analgetics (pain relievers)
- For drug analysis as shown for cinchona bark

Contents of TLC micro-set F₁

1 manual, 50 glass capillaries 1 μ L
50 polyester sheets 4 \times 8 cm each of POLYGRAM[®]:
SIL G/UV₂₅₄ and CEL 300
100 mL each of *n*-butanol, ninhydrin spray reagent (0.2 % in ethanol), acetone, 25 % ammonia solution, rubeanic acid spray reagent
50 mL each of 50 % acetic acid, 18 % hydrochloric acid
8 mL each of the amino acid test mixture (see left), tryptophan and arginine reference solutions
8 mL each of the heavy metal cation test mixture (see left), Cu²⁺ and Mn²⁺ reference solutions

Contents of TLC micro-set F₂

1 manual, 50 glass capillaries 1 μ L
50 polyester sheets 4 \times 8 cm POLYGRAM[®]:
SIL G/UV₂₅₄
5 disposable pipettes 25 μ L
5 sample vials N 11 (1.5 mL) with PE caps and seals
3 sample vials 30 mL (for butter, margarine and edible oil)
100 mL each of cyclohexane and molybdato-phosphoric acid spray reagent
2 \times 50 mL acetone with calibrated pipette
25 mL butan-2-one
8 mL cholesterol reference solution

Contents of TLC micro-set F₃

1 manual, 50 glass capillaries 1 μ L
50 polyester sheets 4 \times 8 cm POLYGRAM[®]:
SIL G/UV₂₅₄
5 Aspirin[®] tablets, 5 Thomapyrin[®] tablets
20 folded filters MN 615 1/4, 11 cm diameter
3 sample vials 8 mL (for Aspirin[®] sample, Thomapyrin[®] sample, cinchona bark extract), 5 g cinchona bark
100 mL each of ethanol, 2-propanol, toluene – diethyl ether (61:39, v/v), spray reagent for caffeine and spray reagent according to Dragendorff-Munier
50 mL each of iron(III) chloride solution and potassium hexacyanoferrate(III) solution, 30 mL ethyl acetate
25 mL each of 12.5 % ammonia solution and diethylamine
8 mL each of caffeine, paracetamol, quinine reference solutions

All experiments with TLC micro-sets F1–F3 require the materials kit (see TLC micro-set M on page 279).



Designation	Pack of	REF
TLC micro-set F1*	1 kit	814200
Refill reagents for TLC micro-set F1		
Amino acid test mixtures (components see previous page)	8 mL	814201
Collection of 4 individual components of the amino acid test mixture	4 × 8 mL	814202
Cation test mixture (components see previous page)	8 mL	814204
Collection of 2 individual components of the cation test mixture (Cu ²⁺ , Mn ²⁺)	2 × 8 mL	814205
TLC micro-set F2*	1 kit	814300
Refill reagents for TLC micro-set F2		
Cholesterol reference solution*	8 mL	814301
TLC micro-set F3*	1 kit	814400
Refill reagents for TLC micro-set F3		
Quinine reference solution*	8 mL	814405
Paracetamol reference solution*	8 mL	814406
Caffeine reference solution*	8 mL	814407
Refill packs TLC sheets for all TLC micro-sets		
TLC polyester sheets POLYGRAM® SIL G/UV ₂₅₄ , 4 × 8 cm	4 × 50	814025
TLC polyester sheets POLYGRAM® AloX N/UV ₂₅₄ , 4 × 8 cm	4 × 50	814026
TLC polyester sheets POLYGRAM® CEL 300, 4 × 8 cm	4 × 50	814027
TLC polyester sheets POLYGRAM® 4 × 8 cm: 100 x SIL G/UV ₂₅₄ ; 50 x AloX N/UV ₂₅₄ ; 50 x CEL 300	1 kit	814028

* These products contain harmful substances which must be specially labeled as hazardous. For detailed information please see SDS. Accessories for TLC micro-sets can be found under TLC accessories on page 303. Spray reagents can be found on page 304.



TLC micro-set M

This kit is prerequisite for the separations with kits F1 to F3. In addition, it serves as basic equipment for the individual study of further thin layer chromatographic experiments.

Contents of TLC micro-set M (materials kit)

2 × 50 glass capillaries 1 µL, 2 spotting guides
 1 rubber cap for capillaries
 1 measuring cylinder 10 mL
 1 beaker 25 mL
 2 developing chambers
 1 glass laboratory sprayer with rubber bulb
 1 plastic syringe 1 mL
 20 sheets filter paper MN 713 (15 × 21 cm)
 50 polyester sheets 4 × 8 cm each of POLYGRAM®:
 SIL G/UV₂₅₄, AloX N/UV₂₅₄ and CEL 300

Designation	Pack of	REF
TLC micro-set M (materials kit)	1 kit	814100

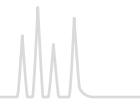

Advantages of MN plates and sheets for TLC

Continuous high quality

- Guaranteed by stringent production control including standardized lot tests, surface checks for roughness or cracks as well as hardness and adherence checks

Comprehensive range of phases for TLC / HPTLC

- There is no universal TLC plate which meets all possible types of analyses
- Our versatile range of TLC ready-to-use layers covers many different types of applications

Immediately ready for chromatographic separation

- Coatings or impregnations are not necessary

Homogeneous, smooth, well adhering layers

- An important criterion especially for reproducible quantitative evaluation



Electron microscope photograph of a cross section through a glass plate with silica layer (magnification × 500)

Adsorbents for MN plates and sheets for TLC

Classical adsorbents

- For ~ 80 % of all TLC separations silica 60 (mean pore diameter 60 Å = 6 nm) is used
- Other classical adsorbents are aluminum oxide, cellulose, kieselguhr, ion exchangers and polyamide

Special phases

- Modified silica, like C₁₈ (octadecyl-) cyano-, amino-, diol-, RP-2
- Special layers for specific separations, like PAH- or enantiomer separation

Particle size distribution and thickness of layer

- Are chosen to fit the given type of application (e.g., HPTLC, standard or preparative separations)
- Most MN ready-to-use layers are available with or without fluorescent indicator

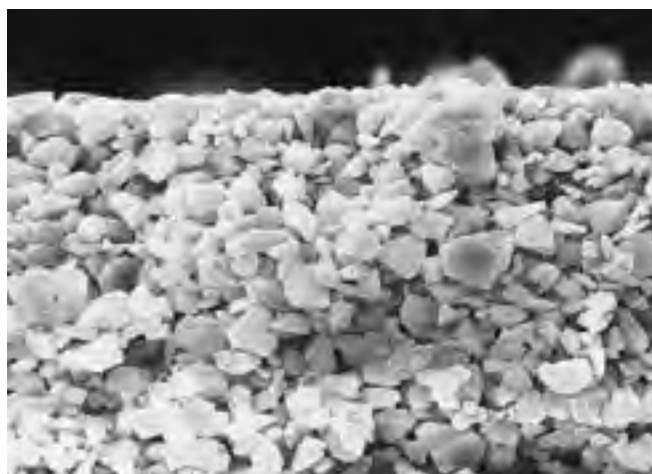

Electron microscope photograph of a cross section through an aluminum sheet with silica layer (magnification × 500)

Supports for ready-to-use layers for TLC

	Glass plates G	POLYGRAM® P	ALUGRAM® A / ALUGRAM® Xtra Ax
Physical properties of support materials			
Material	glass	polyester	aluminum
Thickness (approx.)	1.3 mm	0.2 mm	0.15 mm
Weight, packaging and storage requirements	high	low	low
Torsional strength	ideal	low	relatively high
Temperature stability	high	max. 185 °C	high
Susceptible to breakage	yes	no	no
Can be cut with scissors	no	yes	yes
Chemical resistance of support materials			
Against solvents	high	high	high
Against mineral acids and conc. ammonia	high	high	low
Stability of the binder system of NP plates in water			
Suitability for aqueous detection reagents	depending on phase	very suitable	ALUGRAM®: limited suitability; ALUGRAM® Xtra: very suitable

Summary of MN ready-to-use layers



Summary

Phase	Support*	Layer	Page
Standard silica particle size 5 – 17 µm			
ADAMANT	G	silica 60, improved binder system, optimized particle size distribution	282
SIL G	G P A Ax	silica 60, standard grade	284
DURASIL	G	silica 60, special binder system	285
SIL HD	G	silica 60, optimized binder system, brilliant staining properties	285
SILGUR	G Ax	silica 60 with kieselguhr concentrating zone	287
Unmodified silica for HPTLC particle size 2 – 10 µm			
Nano-SILGUR	G Ax	nano silica 60 with kieselguhr concentrating zone	287
Nano-ADAMANT	G	nano silica 60, improved binder system, optimized particle size distribution	289
Nano-SIL	G A Ax	nano silica 60, standard grade	289
Nano-DURASIL	G	nano silica 60, special binder system	290
Nano-SIL HD	G	nano silica 60, optimized binder system, brilliant staining properties	290
Modified silica for HPTLC particle size 2 – 10 µm			
Nano-SIL C ₁₈ -50 / Nano-SIL C ₁₈ -100	G	nano silica with partial or complete C ₁₈ modification	291
RP-18 W/UV ₂₅₄	G A	nano silica with partial octadecyl modification, wettable with water	292
RP-2/UV ₂₅₄	G A	silanized silica = dimethyl-modified nano silica 60	292
Nano-SIL CN	G A	cyano-modified nano silica	293
Nano-SIL NH ₂	G A	amino-modified nano silica	294
Nano-SIL DIOL	G	diol-modified nano silica	295
Aluminum oxide			
Alox-25 / Alox N	G P A	aluminum oxide	296
Cellulose, unmodified and modified			
CEL 300	G P A	native fibrous cellulose MN 300	297
CEL 400	G P	microcrystalline cellulose MN 400 (AVICEL®)	297
CEL 300 PEI	P	polyethyleneimine-impregnated cellulose ion exchanger	298
POLYAMID-6			
POLYAMID-6	P	perlon = ε-polycaprolactame	298
Layers for special separations			
CHIRALPLATE	G	RP silica with Cu ²⁺ ions and chiral reagent, for enantiomer separation of amino acids	299
SIL N-HR	P	high purity silica 60, special binder system, higher gypsum content	299
SIL G-25 HR	G	high purity silica 60 with gypsum, recommended for aflatoxin analysis	300
SIL G-25 Tenside	G	silica G with ammonium sulfate for separation of surfactants	300
Nano-SIL PAH	G	nano silica with special impregnation for PAH analysis	300
IONEX-25 SA-Na	P	mixed layer of strongly acidic cation exchanger and silica	301
IONEX-25 SB-AC	P	mixed layer of strongly basic anion exchanger and silica	301
SILCEL-Mix	G	mixed layer of cellulose and silica	301
* G = Glass plates P = POLYGRAM® polyester sheets A = ALUGRAM® aluminum sheets Ax = ALUGRAM® Xtra aluminum sheets			

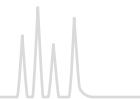

ADAMANT ^G unmodified standard silica layers

★ Key features

- Outstanding hardness and abrasion resistance due to an optimized binder system
- Increased separation efficiency due to an optimized particle size distribution
- High suitability for trace analysis resulting from a UV indicator with increased brilliance and a lownoise background of the layer

🔧 Technical characteristics

- Silica 60, mean pore size 60 Å, specific surface (BET) ~ 500 m²/g, specific pore volume 0.75 mL/g, particle size 5 – 17 μm

Separation of steroids

MN Appl. No. 402930

Layers: ADAMANT UV₂₅₄, SIL G/UV₂₅₄
 Sample: 0.1 % solution in CHCl₃
 Eluent: chloroform – methanol (97:3, v/v)
 Migration distance: ADAMANT 50 mm in 10 min, SIL G 57 mm in 10 min
 Detection: UV

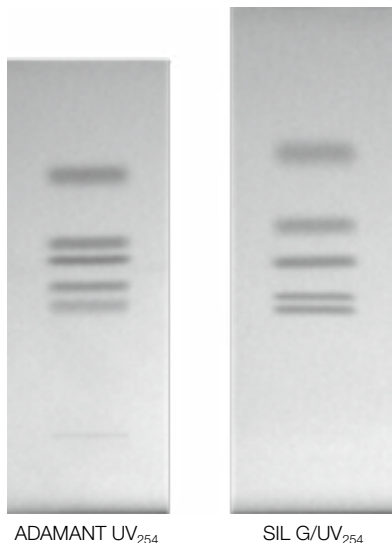

Substance	R _f ADAMANT	R _f SIL G
Cortisone	0.37	0.27
Corticosterone	0.43	0.30
Testosterone	0.50	0.39
Deoxycorticosterone	0.55	0.46
Progesterone	0.73	0.62

Separation of barbiturates

MN Appl. No. 402950

Layer: ADAMANT UV₂₅₄
 Sample volume: 1 μL
 Eluent: chloroform – acetone (95:5, v/v)
 Migration distance: 70 mm in 20 min
 Detection: UV



Substance	R _f
Thiamylal (0.5 %)	0.69
Thiopental (1.0 %)	0.65
Hexobarbital (5.0 %)	0.41
Pentobarbital (1.0 %)	0.26
Phenobarbital (1.0 %)	0.18

Glass plates

Plate size [cm]	2.5 × 7.5	5 × 10	5 × 10	5 × 20	10 × 10	10 × 20	20 × 20	Thickness of layer	Fluorescent indicator
Pack of [plates]	100	50	200	100	25	50	25		
ADAMANT		821040	821040.200		821050		821060	0.25 mm	–
ADAMANT UV ₂₅₄	821005	821010	821010.200	821015	821020	821025	821030	0.25 mm	UV ₂₅₄



ALUGRAM® Xtra SIL G ^{Ax} unmodified standard silica layers on aluminum

★ Key features

- Outstanding wettability for precise colorization results, even with 100 % aqueous detection reagents
- Excellent separation efficiency and reproducibility from lot to lot
- Easy and reliable cutting due to an optimized binder system, no flaking of silica

🔧 Technical characteristics

- Silica 60, mean pore size 60 Å, specific surface (BET) ~ 500 m²/g, specific pore volume 0.75 mL/g, particle size 5 – 17 µm
- Binder: highly polymeric product, which is stable in almost all organic solvents and resistant towards aggressive visualization reagents, also completely stable in purely aqueous eluents

Separation of nutmeg ingredients

MN Appl. No. 403590

Layer: ALUGRAM® Xtra SIL G UV₂₅₄
 Sample: shake 1.0 g freshly powdered drug for 3 min with 4 mL methanol and filter; apply 10 µL
 Eluent: toluene – ethyl acetate (95:5, v/v)
 Migration distance: 15 cm
 Detection: 254 nm: underivatized daylight and 366 nm: spray with 5 % ethanolic sulfuric acid, 1 % vanillic acid and heat to 105 °C

The chromatograms show the following zones with increasing *R_f* values: linalool (bluish grey), eugenol (yellowish brown), myristicin (reddish brown), and anethole (pink-violet). Other colored zones may appear.

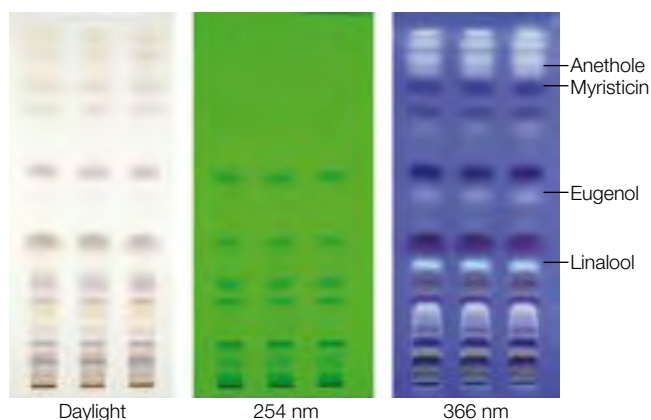

ALUGRAM® Xtra aluminum sheets

Plate size [cm]	2.5 × 7.5	4 × 8	5 × 7.5	5 × 10	5 × 20	10 × 20	20 × 20	Thickness of layer	Fluorescent indicator
Pack of [plates]	200	50	20	50	50	20	25		
SIL G			818230.20	818261	818232		818233	0.20 mm	–
SIL G/UV ₂₅₄	818329	818331	818330.20	818360	818332	818362	818333	0.20 mm	UV ₂₅₄

Further application examples can be found online in our application database at ChromaAppDB.mn-net.com



Unmodified TLC silica layers

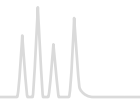

SIL G G P A unmodified standard silica layers

Technical characteristics

- Silica 60, mean pore size 60 Å, specific surface (BET) ~ 500 m²/g, specific pore volume 0.75 mL/g, particle size 5 – 17 µm
- Thickness of layer for analytical plates 0.25 mm, for preparative plates 0.5 and 1 mm; for 2 mm preparative layers a slightly coarser material is used
- Indicators: manganese activated zinc silicate with green fluorescence for short-wave UV (254 nm); special inorganic fluorescent pigment with blue fluorescence for long-wave UV (366 nm)
- Binders: highly polymeric products, which are stable in almost all organic solvents and resistant towards aggressive visualization reagents; binder system for POLYGRAM[®] sheets is also completely stable in purely aqueous eluents

Glass plates

Plate size [cm]	2.5 x 7.5	5 x 10	5 x 10	5 x 20	10 x 10	10 x 20	20 x 20	Thickness of layer
Pack of [plates]	100	50	200	100	25	50	25	
SIL G-25		809017	809017.200	809011		809012	809013	0.25 mm
SIL G-25 UV ₂₅₄	809028.100	809027	809027.200	809021	809020	809022	809023	0.25 mm
SIL G-25 UV _{254 + 366}				809121		809122	809123	0.25 mm

Glass plates

Plate size [cm]	2.5 x 7.5	5 x 10	5 x 10	5 x 20	10 x 10	10 x 20	20 x 20	Thickness of layer
Pack of [plates]	(preparative TLC)						20	
SIL G-50							809051	0.50 mm
SIL G-50 UV ₂₅₄							809053	0.50 mm

Glass plates

Plate size [cm]	2.5 x 7.5	5 x 10	5 x 10	5 x 20	10 x 10	10 x 20	20 x 20	Thickness of layer
Pack of [plates]	(preparative TLC)						15	
SIL G-100							809061	1.00 mm
SIL G-100 UV ₂₅₄							809063	1.00 mm

Glass plates

Plate size [cm]	2.5 x 7.5	5 x 10	5 x 10	5 x 20	10 x 10	10 x 20	20 x 20	Thickness of layer
Pack of [plates]	(preparative TLC)						12	
SIL G-200							809073	2.00 mm
SIL G-200 UV ₂₅₄							809083	2.00 mm

POLYGRAM[®] polyester sheets

Plate size [cm]	2.5 x 7.5	4 x 8		5 x 20		20 x 20	40 x 20	
Pack of [plates]	200	50		50		25	25	
SIL G	805902	805032		805012		805013	805014	0.20 mm
SIL G/UV ₂₅₄	805901	805021		805022		805023	805024	0.20 mm
SIL G/UV ₂₅₄						roll 500 x 20 cm	805017	0.20 mm

ALUGRAM[®] aluminum sheets

Plate size [cm]	2.5 x 7.5	4 x 8	5 x 7.5	5 x 10	5 x 20	10 x 20	20 x 20	
Pack of [plates]	200	50	20	50	50	20	25	
SIL G			818030.20	818161	818032	818163	818033	0.20 mm
SIL G/UV ₂₅₄	818129	818131	818130.20	818160	818132	818162	818133	0.20 mm

Further application examples can be found online in our application database at ChromaAppDB.mn-net.com

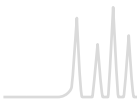

DURASIL ^G unmodified standard silica layers

Technical characteristics

- Silica 60, mean pore size 60 Å, specific surface (BET) ~ 500 m²/g, specific pore volume 0.75 mL/g, particle size 5 – 17 µm
- Hard, water-resistant and wettable layers due to a special binder system

Glass plates

Plate size [cm]	5 × 10	5 × 10	5 × 20	10 × 20	20 × 20	Thickness of layer	Fluorescent indicator
Pack of [plates]	50	200	100	50	25		
DURASIL-25				812003	812004	0.25 mm	–
DURASIL-25 UV ₂₅₄	812005	812005.200	812006	812007	812008	0.25 mm	UV ₂₅₄

SIL HD ^G unmodified standard silica layers

Key features

- Outstanding dyeability and abrasion resistance due to an optimized binder system
- Good wettability for precise colorization results, even with
- 100 % aqueous detection reagents
- Excellent separation efficiency due to an optimized
- particle size distribution
- High suitability for trace analyses resulting from a UV
- Indicator with increased brilliance and a low-noise back
- Ground of the layer

Technical characteristics

- Silica 60, mean pore size 60 Å, specific surface (BET) ~ 500 m²/g, specific pore volume 0.75 mL/g, particle size 5 – 17 µm

Glass plates

Plate size [cm]	5 × 10	10 × 10	10 × 20	20 × 20	Thickness of layer	Fluorescent indicator
Pack of [plates]	50	25	50	25		
SIL HD	809217	809210	809212	809213	0.25 mm	–
SIL HD UV ₂₅₄	809227	809220	809222	809223	0.25 mm	UV ₂₅₄

The most TLC layers are available as glass plate, polyester- or aluminum sheet (also see page 280 and 281).

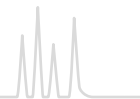

MN TLC pre-coated layers – qualitative and individual tailored

Kieselguhr zone

- For rapid sample application
- Because kieselguhr is completely inert towards a large number of compounds, the samples always form a narrow band at the interface of the two adsorbents, irrespective of shape, size or position of the spots in the concentrating zone. Separation then takes place in the silica layer.

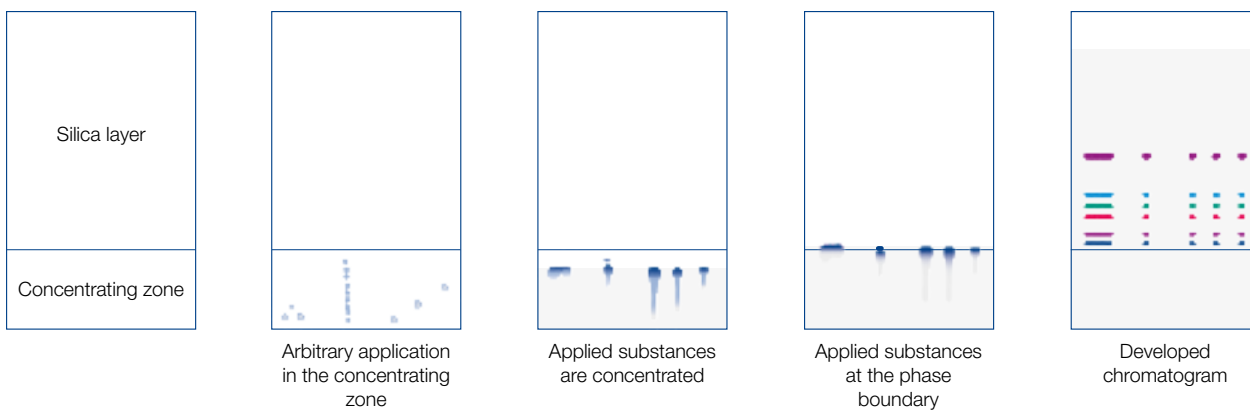

Silica layers with concentrating zone



SILGUR ^G ^{Ax} unmodified standard silica layers with concentrating zone

Technical characteristics

- Silica 60, mean pore size 60 Å, specific surface (BET) ~ 500 m²/g, specific pore volume 0.75 mL/g, particle size 5 – 17 µm
- Kieselguhr zone for rapid sample application (see page 286)
- Channel-plate with 19 channels help to prevent cross contamination by separating several samples
- More samples can be separated on a plate, and spot areas can be more easily determined

Glass plates

Plate size [cm]	10 × 20	20 × 20	Thickness of layer	Fluorescent indicator
Pack of [plates]	50	25		
SILGUR-25	810012	810013	0.25 mm	–
SILGUR-25 UV ₂₅₄	810022	810023	0.25 mm	UV ₂₅₄

Channel-Plates

Pack of [plates]	25			
SILGUR-25-C UV ₂₅₄	810123	0.25 mm	UV ₂₅₄	

ALUGRAM[®] Xtra aluminum sheets

Pack of [plates]	20	25		
SILGUR	818412	818413	0.20 mm	–
SILGUR UV ₂₅₄	818422	818423	0.20 mm	UV ₂₅₄



Nano-SILGUR ^G ^{Ax} unmodified HPTLC silica layers with concentrating zone

Technical characteristics

- Nano silica 60, pore size 60 Å, specific surface (BET) ~ 500 m²/g, mean specific pore volume 0.75 mL/g, particle size 2 – 10 µm
- Kieselguhr zone for rapid sample application (see page 286)

Glass plates

Plate size [cm]	10 × 10	Thickness of layer	Fluorescent indicator
Pack of [plates]	25		
Nano-SILGUR-20	811032	0.20 mm	–
Nano-SILGUR-20 UV ₂₅₄	811042	0.20 mm	UV ₂₅₄

ALUGRAM[®] Xtra aluminum sheets

Plate size [cm]	10 × 10	Thickness of layer	Fluorescent indicator
Pack of [plates]	25		
Nano-SILGUR	818432	0.20 mm	–
Nano-SILGUR UV ₂₅₄	818442	0.20 mm	UV ₂₅₄

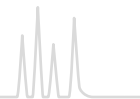

Sharper separation by nano silica

Nano silica for HPTLC

- Narrow fractionation of the silica particles allows theoretical plate heights, which are one order of magnitude smaller than on standard silica layers.

Advantages

- Shorter migration distances
- Lower amount of samples required
- Increased detection sensitivity with equal selectivity
- Less developing time



Nano silica

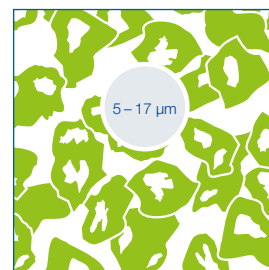

Standard silica

Comparison of ADAMANT and Nano-ADAMANT plates for separation of anthraquinone dyes

Layers: A) ADAMANT
B) Nano-ADAMANT
Sample: 1 μL , about 0.1 %
Eluent: toluene – cyclohexane (4:3, v/v)
Migration time: A) 30 min, B) 15 min

Peaks:
1. Blue 3
2. Violet 2
3. Red
4. Green
5. Blue 1
6. Greenish blue
7. Violet 1

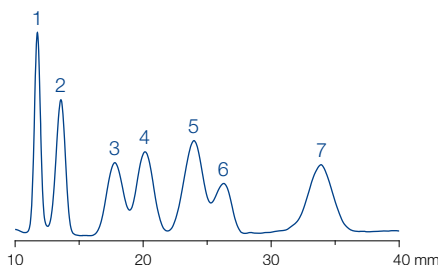
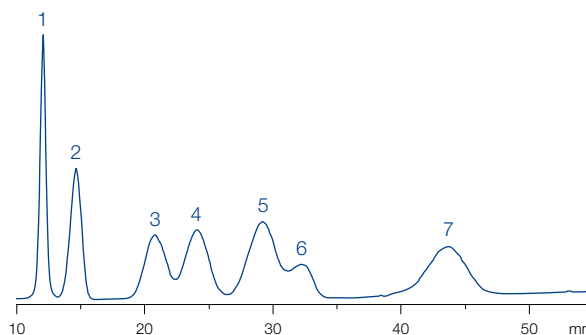

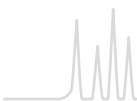

Unmodified HPTLC silica layers



Nano-ADAMANT ^G unmodified HPTLC silica layers

★ Key features

- Outstanding hardness and abrasion resistance due to an optimized binder system
- Increased separation efficiency due to an optimized particle size distribution
- High suitability for trace analyses resulting from a UV indicator with increased brilliance and a lownoise background of the layer

🔧 Technical characteristics

- Nano silica 60, mean pore size 60 Å, specific surface (BET) ~ 500 m²/g, specific pore volume 0.75 mL/g, particle size 2–10 µm

Glass plates

Plate size [cm]	10 × 10	10 × 20	Thickness of layer	Fluorescent indicator
Pack of [plates]	25	50		
Nano-ADAMANT	821140	821150	0.20 mm	–
Nano-ADAMANT UV ₂₅₄	821110	821120	0.20 mm	UV ₂₅₄

Nano-SIL ^{G Ax A} unmodified HPTLC silica layers

🔧 Technical characteristics

- Nano silica 60, mean pore size 60 Å, specific surface (BET) ~ 500 m²/g, specific pore volume 0.75 mL/g, particle size 2–10 µm
- Indicator: manganese activated zinc silicate with green fluorescence for short-wave UV (254 nm)
- Binder: highly polymeric product, which is stable in almost all organic solvents and resistant towards aggressive visualization reagents

Glass plates

Plate size [cm]	5 × 5	5 × 20	10 × 10	10 × 20	20 × 20	Thickness of layer	Fluorescent indicator
Pack of [plates]	100	50	25	50	25		
Nano-SIL-20	811011		811012	811013		0.20 mm	–
Nano-SIL-20 UV ₂₅₄	811021		811022	811023		0.20 mm	UV ₂₅₄

ALUGRAM[®] Xtra aluminum sheets

Plate size [cm]	5 × 5	5 × 20	10 × 10	10 × 20	20 × 20	Thickness of layer	Fluorescent indicator
Pack of [plates]	100	50	25	50	25		
Nano-SIL G		818240			818241	0.20 mm	–
Nano-SIL G/UV ₂₅₄		818342			818343	0.20 mm	UV ₂₅₄

ALUGRAM[®] aluminum sheets

Plate size [cm]	5 × 5	5 × 20	10 × 10	10 × 20	20 × 20	Thickness of layer	Fluorescent indicator
Pack of [plates]	100	50	25	50	25		
Nano-SIL G					818141	0.20 mm	–
Nano-SIL G/UV ₂₅₄					818143	0.20 mm	UV ₂₅₄



Unmodified HPTLC silica layers

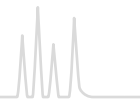

Nano-DURASIL unmodified HPTLC silica layers

Technical characteristics

- Nano silica 60, mean pore size 60 Å, specific surface (BET) ~ 500 m²/g, specific pore volume 0.75 mL/g, particle size 2 – 10 µm
- Indicator: manganese activated zinc silicate with green fluorescence for short-wave UV (254 nm)
- Hard, water-resistant and wettable layers due to a special binder system
- Different selectivity compared to ADAMANT and SIL-G plates no reversed phase tendency, more polar than Nano-SIL

Glass plates

Plate size [cm]	10 × 10	10 × 20	Thickness of layer	Fluorescent indicator
Pack of [plates]	25	50		
Nano-DURASIL-20	812010	812011	0.20 mm	–
Nano-DURASIL-20 UV ₂₅₄	812013	812014	0.20 mm	UV ₂₅₄

Nano-SIL HD unmodified standard silica layers

Key features

- Outstanding dyeability and abrasion resistance due to an optimized binder system
- Good wettability for precise colorization results, even with 100 % aqueous detection reagents
- Excellent separation efficiency due to an optimized particle size distribution
- High suitability for trace analyses resulting from a UV indicator with increased brilliance and a low-noise background of the layer

Technical characteristics

- Nano silica 60, mean pore size 60 Å, specific surface (BET) ~ 500 m²/g, specific pore volume 0.75 mL/g, particle size 2 – 10 µm

Glass plates

Plate size [cm]	5 × 5	10 × 10	10 × 20	Thickness of layer	Fluorescent indicator
Pack of [plates]	100	25	50		
Nano-SIL HD	811211	811212	811213	0.20 mm	–
Nano-SIL HD UV ₂₅₄	811221	811222	811223	0.20 mm	UV ₂₅₄



Nano-SIL C₁₈ ^G octadecyl-modified HPTLC silica layers

🔧 Technical characteristics

- Nano silica 60, mean pore size 60 Å, specific surface (BET) ~ 500 m²/g, specific pore volume 0.75 mL/g, pH stability 2 – 10, particle size 2 – 10 µm
- Indicator: acid-resistant product with a pale blue fluorescence for short-wave UV (254 nm), UV-absorbing substances appear as dark-blue to black spots on a light-blue background

🔧 Modification

- Partial (50 %) or complete (100 %) octadecyl modification, carbon content 7.5 and 14 %, respectively
- Order of polarity: silica > DIOL > NH₂ > CN > RP-2 > C₁₈-50 > RP-18 W > C₁₈-100

✅ Recommended application

- Reversed phase separation mode with eluents from anhydrous solvents to mixtures with high concentrations of water (see table and figure below)
- Alkaloids, amino acids, preservatives, optical brighteners, barbiturates, polycyclic aromatic hydrocarbons (PAH), drugs, peptides, flavonoids, phenols, indole derivatives, steroids

Glass plates

Plate size [cm]		10 x 10	Thickness of layer	Fluorescent indicator
Pack of [plates]		25		
Nano-SIL C ₁₈ -50	50 % silanized	811054	0.20 mm	–
Nano-SIL C ₁₈ -50 UV ₂₅₄	50 % silanized	811064	0.20 mm	UV ₂₅₄
Nano-SIL C ₁₈ -100	100 % silanized	811052	0.20 mm	–
Nano-SIL C ₁₈ -100 UV ₂₅₄	100 % silanized	811062	0.20 mm	UV ₂₅₄

Eluent	v/v	Migration distances [mm/15 min]		
		C ₁₈ -50	C ₁₈ -100	RP-18 W
Methanol – H ₂ O	2:1	57	45	44
	1:1	52	21	40
	1:2	50	0	43
	1:3	40	0	45
	1:4	30	0	46
Acetonitrile – H ₂ O	2:1	62	46	66
	1:1	52	30	54
	1:2	51	27	46
	1:3	48	15	44
Trichloromethane		68	64	71

Migration of C₁₈-50 and C₁₈-100 silica layers as compared to RP-18 W plates

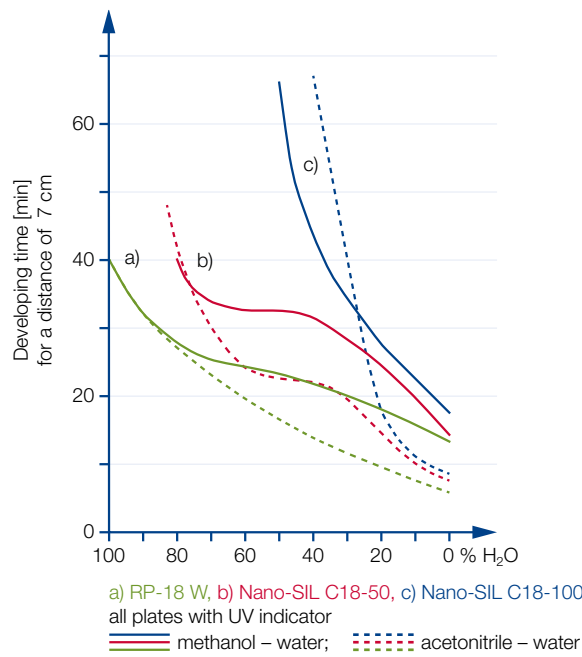

Elution properties of MN RP plates in mixtures of methanol – water and acetonitrile – water

Further application examples can be found online in our application database at ChromaAppDB.mn-net.com



Modified silica layers

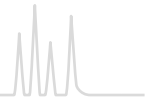

RP-18 W/UV₂₅₄ G A octadecyl-modified HPTLC silica layers

Technical characteristics

- Nano silica 60, mean pore size 60 Å, specific surface (BET) ~ 500 m²/g, specific pore volume 0.75 mL/g, particle size 2 – 10 µm, for preparative plates (1 mm thickness of layer) standard silica 60, pH stability 2 – 10, particle size 5 – 17 µm
- Indicator: acid-resistant product with a pale blue fluorescence for short-wave UV (254 nm), UV-absorbing substances appear as dark-blue to black spots on a light-blue background

Modification

- Partial octadecyl (C₁₈) modification, wettable with water, carbon content 7.5 %
- Order of polarity:
silica > DIOL > NH₂ > CN
> RP-2 > C₁₈-50 > RP-18 W
> C₁₈-100

Recommended application

- NP or RP separation with eluents from anhydrous solvents to mixtures with high concentrations of water (see table and figure on previous page), relative polarity of the eluent determines the polarity of the layer
- Aminophenols, barbiturates, preservatives, nucleobases, polycyclic aromatic hydrocarbons, steroids, tetracyclines, plasticizers (phthalates)

Glass plates

Plate size [cm]	4 × 8	5 × 10	5 × 20	10 × 10	10 × 20	20 × 20	Thickness of layer	Fluorescent indicator
Pack of [plates]			50	25	50	25		
RP-18 W/UV ₂₅₄			811073	811075	811072	811071	0.25 mm	UV ₂₅₄

Plate size [cm]	4 × 8	5 × 10	5 × 20	10 × 10	10 × 20	20 × 20	Thickness of layer	Fluorescent indicator
Pack of [plates] (preparative TLC)						15		
RP-18 W/UV ₂₅₄						811074	1.00 mm	UV ₂₅₄

ALUGRAM® aluminum sheets

Plate size [cm]	4 × 8	5 × 10	5 × 20	10 × 10	10 × 20	20 × 20	Thickness of layer	Fluorescent indicator
Pack of [plates]	50	50	50	25	25			
RP-18 W/UV ₂₅₄	818144	818152	818145	818147		818146	0.15 mm	UV ₂₅₄

RP-2/UV₂₅₄ G A "silanized silica" = dimethyl-modified standard silica layers

Technical characteristics

- Silica 60, mean pore size 60 Å, specific surface (BET) ~ 500 m²/g, specific pore volume 0.75 mL/g, pH stability 2 – 10, particle size 5 – 17 µm
- Indicator: acid-resistant product with a pale blue fluorescence for short-wave UV (254 nm), UV-absorbing substances appear as dark-blue to black spots on a light-blue background

Modification

- Silanized silica with dimethyl modification, carbon content 4 %
- Order of polarity:
silica > DIOL > NH₂ > CN
> RP-2 > C₁₈-50 > RP-18 W
> C₁₈-100

Recommended application

- Normal phase or reversed phase separation modes with purely organic, organic - aqueous or purely aqueous eluents
- Active plant constituents, steroids

Glass plates

Plate size [cm]	10 × 20	20 × 20	Thickness of layer	Fluorescent indicator
Pack of [plates]	50	25		
RP-2/UV ₂₅₄	811081	811082	0.25 mm	UV ₂₅₄

ALUGRAM® aluminum sheets

Plate size [cm]	10 × 20	20 × 20	Thickness of layer	Fluorescent indicator
Pack of [plates]	50	25		
RP-2/UV ₂₅₄		818171	0.15 mm	UV ₂₅₄



Nano-SIL CN G A cyano-modified HPTLC silica layers

🔧 Technical characteristics

- Nano silica 60, mean pore size 60 Å, specific surface (BET) ~ 500 m²/g, specific pore volume 0.75 mL/g, pH stability 2–8, particle size 2–10 μm
- Indicator: acid-resistant product with a pale blue fluorescence for short-wave UV (254 nm), UV-absorbing substances appear as dark-blue to black spots on a light-blue background

🔧 Modification

- Cyanopropyl modification, carbon content 5.5%
- Order of polarity: silica > DIOL > NH₂ > CN > RP-2 > C₁₈-50 > RP-18 W > C₁₈-100

✅ Recommended application

- NP or RP separation modes depending on the polarity of the developing solvent (see figure below)
- Steroid hormones, phenols, preservatives

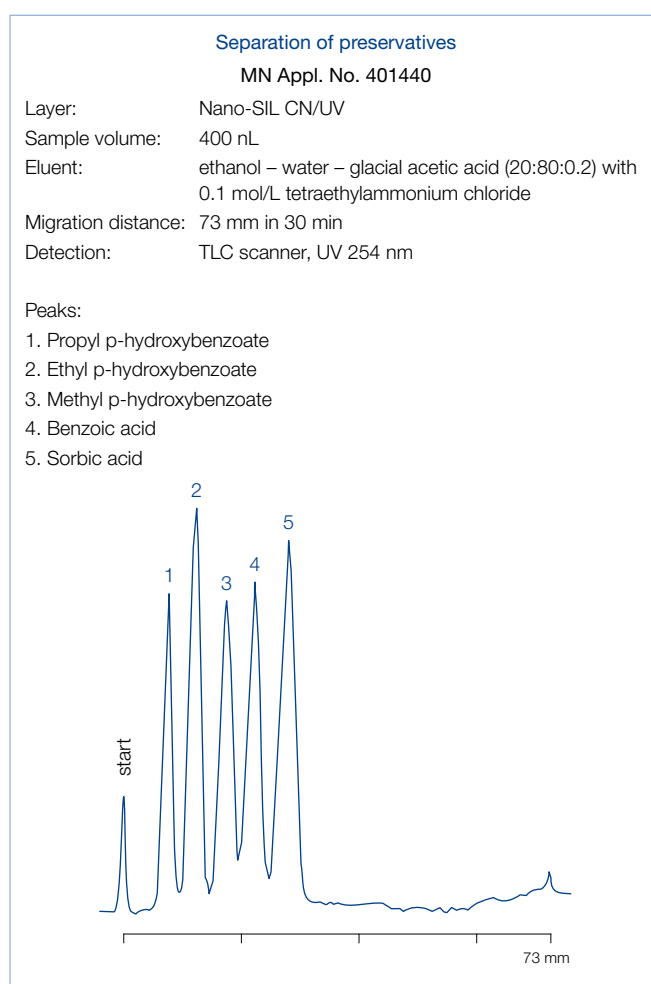
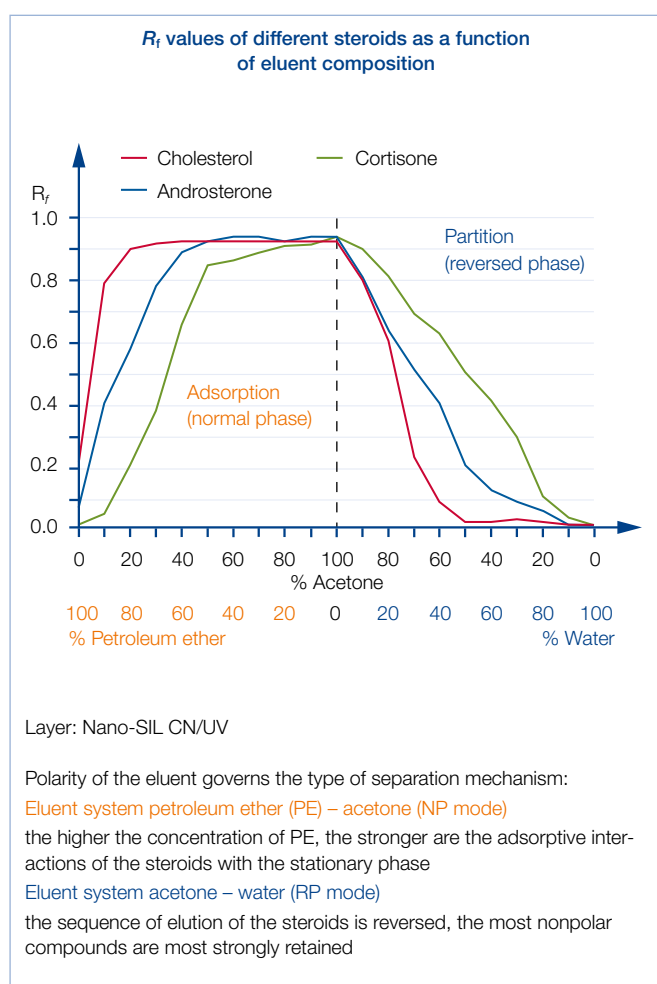

Glass plates

Plate size [cm]	4 × 8	10 × 10	10 × 20	Thickness of layer	Fluorescent indicator
Pack of [plates]	50	25	25		
Nano-SIL CN/UV		811115	811116	0.20 mm	UV ₂₅₄

ALUGRAM® aluminum sheets

Plate size [cm]	4 × 8	10 × 10	10 × 20	Thickness of layer	Fluorescent indicator
Pack of [plates]	50	25	25		
Nano-SIL CN/UV		818184		0.15 mm	UV ₂₅₄



Modified silica layers

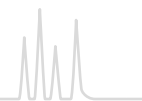

Nano-SIL NH₂ G A amino-modified HPTLC silica layers

🔧 Technical characteristics

- Nano silica 60, mean pore size 60 Å, specific surface (BET) ~ 500 m²/g, specific pore volume 0.75 mL/g, pH stability 2–8, particle size 2–10 μm
- Indicator: acid-resistant product with a pale blue fluorescence for short-wave UV (254 nm), UV-absorbing substances appear as dark-blue to black spots on a light-blue background

🔧 Modification

- Aminopropyl modification, carbon content 3.5 %
- Order of polarity: silica > DIOL > NH₂ > CN > RP-2 > C₁₈-50 > RP-18 W > C₁₈-100
- Layer can be wetted equally well with pure water as with organic solvents

✅ Recommended application

- Vitamins, sugars, steroids, purine derivatives, xanthenes, phenols, nucleotides and pesticides

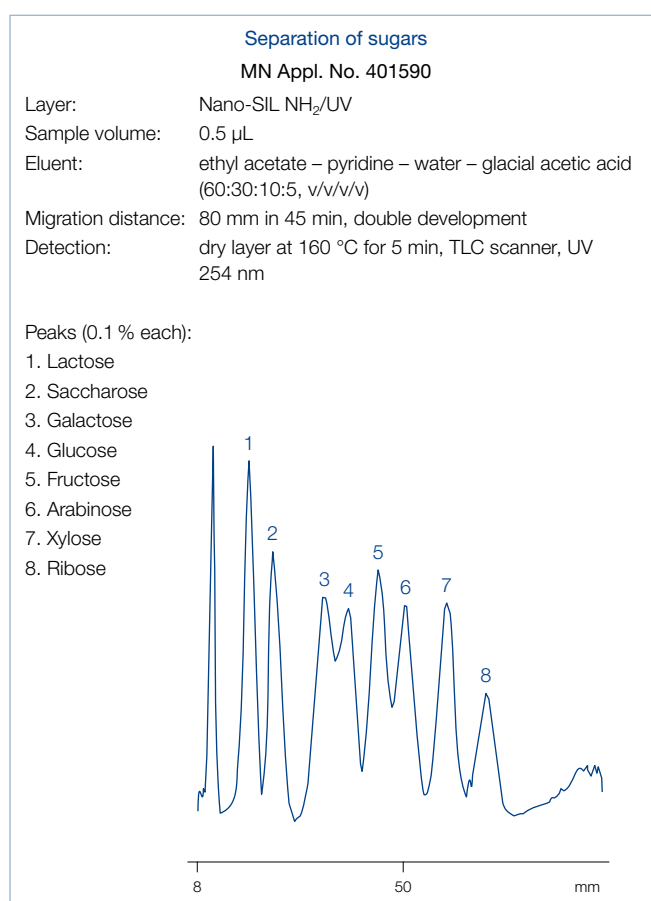
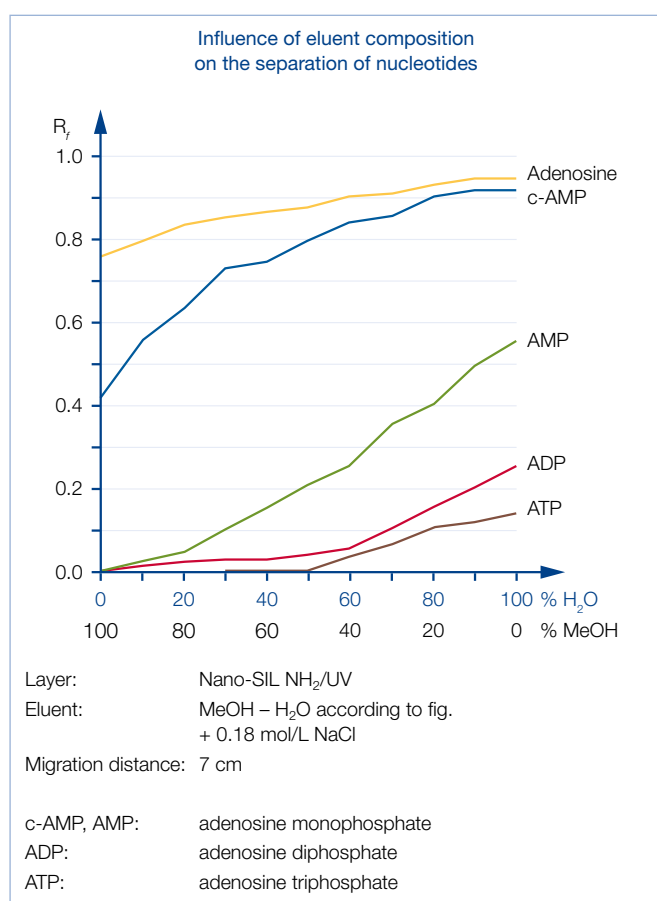

Glass plates

Plate size [cm]	4 × 8	10 × 10	10 × 20	Thickness of layer	Fluorescent indicator
Pack of [plates]	50	25	25		
Nano-SIL NH ₂ /UV		811111	811112	0.20 mm	UV ₂₅₄

ALUGRAM® aluminum sheets

Plate size [cm]	4 × 8	10 × 10	10 × 20	Thickness of layer	Fluorescent indicator
Pack of [plates]	50	25	25		
Nano-SIL NH ₂ /UV		818182		0.15 mm	UV ₂₅₄

Further application examples can be found online in our application database at ChromaAppDB.mn-net.com



Nano-SIL DIOL ^G diol-modified HPTLC silica layers

🔧 Technical characteristics

- Nano silica 60, mean pore size 60 Å, specific surface (BET) ~ 500 m²/g, specific pore volume 0.75 mL/g, pH stability 2–8, particle size 2–10 µm
- Indicator: acid-resistant product with a pale blue fluorescence for short-wave UV (254 nm), UV-absorbing substances appear as dark-blue to black spots on a light-blue background

🔧 Modification

- Diol modification, carbon content 5.5 %
- Order of polarity: silica > DIOL > NH₂ > CN > RP-2 > C₁₈-50 > RP-18 W > C₁₈-100
- Layer can be wetted equally well with pure water as with organic solvents

✅ Recommended application

- Steroids, pesticides and plant constituents
- For critical separations an alternative to silica
- Since it is less sensitive to the water content of the environment, leads to more reproducible results compared to silica

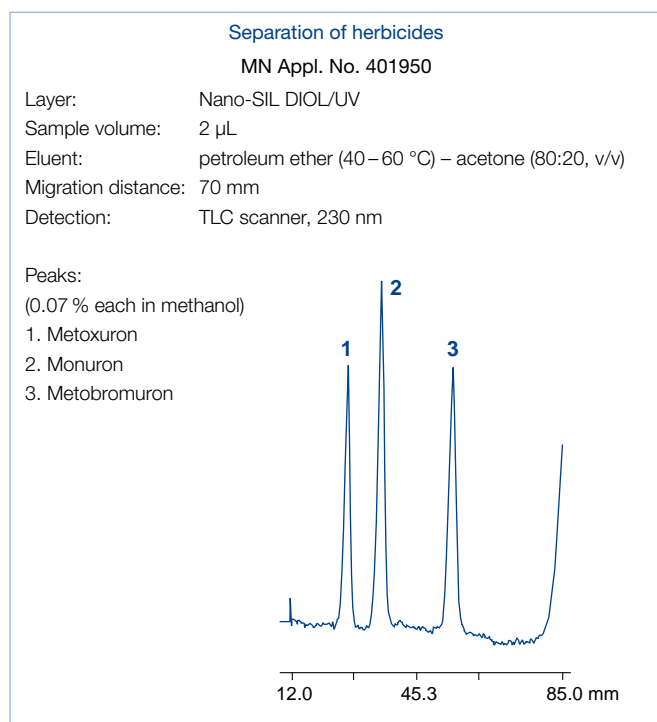

Glass plates

Plate size [cm]	10 × 10	Thickness of layer	Fluorescent indicator
Pack of [plates]	25		
Nano-SIL DIOL/UV	811120	0.20 mm	UV ₂₅₄

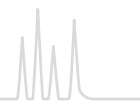

Alox **G P A** aluminum oxide layers

Technical characteristics

- Aluminum oxide, mean pore size 60 Å, specific surface (BET) ~ 200 m²/g
- Inert organic binder
- Indicator: manganese-activated zinc silicate

Recommended application

- Terpenes, alkaloids, steroids, aliphatic and aromatic compounds
- We recommend to activate aluminum oxide layers before use by heating 10 minutes at 120 °C

Separation of bisadducts of fullerenes

MN Appl. No. 401930

F. Djojo, A. Hirsch, Chem. Eur. J. 4 (1998), 344–356

Layer: ALUGRAM® Alox N/UV₂₅₄

Eluent: toluene – ethyl acetate (95:5, v/v)

Detection: UV, 254 nm

Compound	R _f values
Bis[bis(4-phenyloxazolin)methane]fullerene 1	0.14
Bis[bis(4-phenyloxazolin)methane]fullerene 2	0.26

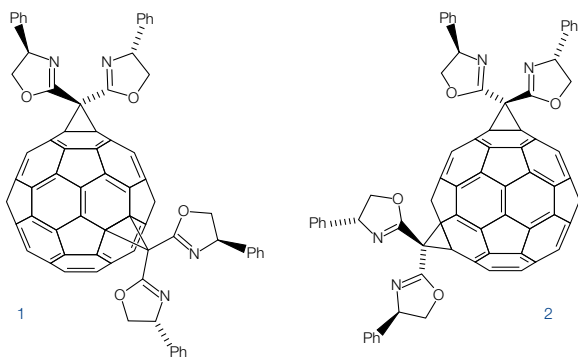

Separation of lipophilic dyes

MN Appl. No. 403010

Layer: Alox-25 UV₂₅₄

Sample volume: 1000 nL

Eluent: toluene – cyclohexane (2:1, v/v)

Migration distance: 108 mm in 15 min

Detection: TLC scanner, UV 254 nm

Peaks:

- Indophenol
- Sudan red G
- Sudan blue II
- Butter yellow

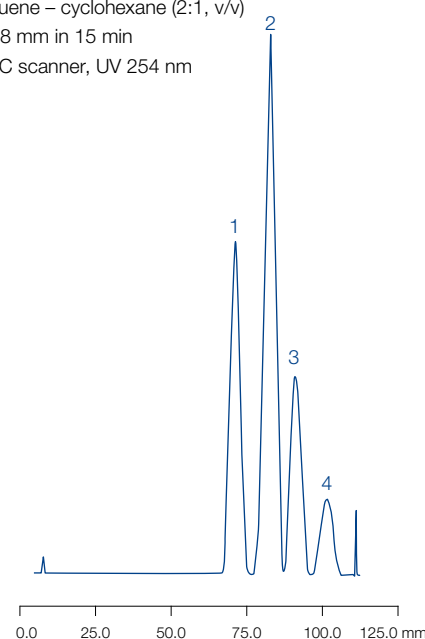

Glass plates

Plate size [cm]	4 × 8	5 × 20	20 × 20	Thickness of layer	Fluorescent indicator
Pack of [plates]		100	25		
Alox-25 UV ₂₅₄		807021	807023	0.25 mm	UV ₂₅₄
Pack of [plates] (preparative TLC)			15		
Alox-100 UV ₂₅₄			807033	1.00 mm	UV ₂₅₄

POLYGRAM® polyester sheets

Plate size [cm]	4 × 8	5 × 20	20 × 20	Thickness of layer	Fluorescent indicator
Pack of [plates]	50	50	25		
Alox N/UV ₂₅₄	802021	802022	802023	0.20 mm	UV ₂₅₄

ALUGRAM® aluminum sheets

Plate size [cm]	4 × 8	5 × 20	20 × 20	Thickness of layer	Fluorescent indicator
Pack of [plates]		50	25		
Alox N/UV ₂₅₄		818024	818023	0.20 mm	UV ₂₅₄

Further application examples can be found online in our application database at ChromaAppDB.mn-net.com

 Cellulose MN 300 G P A native fibrous cellulose layers

✔ Technical characteristics

- Fiber length (95 %) 2–20 µm, average degree of polymerization 400–500, specific surface acc. to Blaine 15,000 cm²/g, ≤ 20 ppm Fe, 6 ppm Cu, 7 ppm P; CH₂Cl₂-extract ≤ 0.25 %; residue on ignition at 850 °C ≤ 1500 ppm

✔ Recommended application

- Partition chromatography of polar substances such as amino acids, carboxylic acids or carbohydrates

Glass plates

Plate size [cm]	4 × 8	5 × 20	20 × 20	Thickness of layer	Fluorescent indicator
Pack of [plates]			25		
CEL 300-10			808013	0.10 mm	–
CEL 300-10 UV ₂₅₄			808023	0.10 mm	UV ₂₅₄
CEL 300-25			808033	0.25 mm	–
CEL 300-25 UV ₂₅₄			808043	0.25 mm	UV ₂₅₄

Plate size [cm]	4 × 8	5 × 20	20 × 20	Thickness of layer	Fluorescent indicator
Pack of [plates] (preparative TLC)			20		
CEL 300-50			808053	0.50 mm	–
CEL 300-50 UV ₂₅₄			808063	0.50 mm	UV ₂₅₄

POLYGRAM® polyester sheets

Plate size [cm]	4 × 8	5 × 20	20 × 20	Thickness of layer	Fluorescent indicator
Pack of [plates]	50	50	25		
CEL 300	801011		801013	0.10 mm	–
CEL 300 UV ₂₅₄		801022	801023	0.10 mm	UV ₂₅₄

ALUGRAM® aluminum sheets

Plate size [cm]	4 × 8	5 × 20	20 × 20	Thickness of layer	Fluorescent indicator
Pack of [plates]	50	50	25		
CEL 300	818155		818153	0.10 mm	–
CEL 300 UV ₂₅₄		818157	818156	0.10 mm	UV ₂₅₄

 Cellulose MN 400 (AVICEL®) G P microcrystalline cellulose layers

✔ Technical characteristics

- Prepared by hydrolysis of high purity cellulose with HCl, average degree of polymerization 40–200

✔ Recommended application

- Carboxylic acids, lower alcohols, urea and purine derivatives

Glass plates

Plate size [cm]	10 × 20	20 × 20	Thickness of layer	Fluorescent indicator
Pack of [plates]	50	25		
CEL 400-10	808072	808073	0.10 mm	–

POLYGRAM® polyester sheets

Plate size [cm]	10 × 20	20 × 20	Thickness of layer	Fluorescent indicator
Pack of [plates]	50	25		
CEL 400		801113	0.10 mm	–
CEL 400 UV ₂₅₄		801123	0.10 mm	UV ₂₅₄

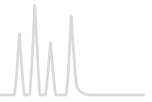

Cellulose MN 300 PEI ^P PEI-impregnated cellulose ion exchange layers

Technical characteristics

- Fibrous cellulose impregnated with polyethyleneimine

Recommended application

- Analysis of nucleic acids, and of mutagenic substances with the ³²P postlabelling procedure

POLYGRAM[®] polyester sheets

Plate size [cm]	20 × 20	Thickness of layer	Fluorescent indicator
Pack of [plates]	25		
CEL 300 PEI	801053	0.10 mm	–
CEL 300 PEI/UV ₂₅₄	801063	0.10 mm	UV ₂₅₄

Polyamid-6 ^P ε-polycaprolactame layers

Technical characteristics

- Polyamide 6 = nylon 6 = perlon = ε-aminopolycaprolactame
- Separation mechanism based on hydrogen bonds to amide groups of the polymer matrix as well as on ionic, dipole and electron donor-acceptor interactions

Recommended application

- Natural compounds, phenols, carboxylic acids, aromatic nitro compounds and especially amino acids

POLYGRAM[®] polyester sheets

Plate size [cm]	5 × 20	20 × 20	Thickness of layer	Fluorescent indicator
Pack of [plates]	50	25		
POLYAMID-6	803012	803013	0.10 mm	–
POLYAMID-6 UV ₂₅₄	803022	803023	0.10 mm	UV ₂₅₄

Further application examples can be found online in our application database at ChromaAppDB.mn-net.com



CHIRALPLATE ^G special layer enantiomer separation

Technical characteristics

- Reversed phase nano silica impregnated with Cu²⁺ ions and a chiral selector (proline derivative)
- Separation based on ligand exchange, i.e. formation of ternary mixed-ligand complexes with the Cu(II) ions, differences in the stability of the diastereomeric complexes cause chromatographic separation

Recommended application

- Enantiomer separation of amino acids, *N*-methylamino acids, *N*-formylamino acids, α -alkylamino acids, thiazolidine derivatives, dipeptides, lactones, α -hydroxycarboxylic acids

Enantiomer separation of amino acids

MN Appl. No. 400520

Quantitative determination (remission location curves) of TLC-separated enantiomers of *tert*.-leucine:

Layer: CHIRALPLATE
 Eluent: methanol – water (10:80, v/v)
 Detection: dip in 0.3 % ninhydrin solution
 quantification with scanner, 520 nm

- a) *L*-*tert*.-leucine
- b) *L*-*tert*.-leucine + 0.1 % *D*-*tert*.-leucine
- c) *L*-*tert*.-leucine + 1 % *D*-*tert*.-leucine
- d) external reference sample

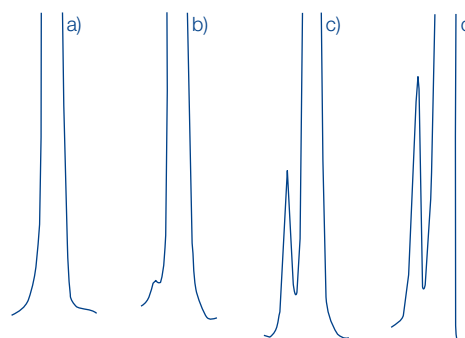

Glass plates

Plate size [cm]	5 × 20	10 × 10	10 × 20	20 × 20	Thickness of layer	Fluorescent indicator
Pack of [plates]			4			
CHIRALPLATE			811056		0.25 mm	UV ₂₅₄

Plate size [cm]	5 × 20	10 × 10	10 × 20	20 × 20	Thickness of layer	Fluorescent indicator
Pack of [plates]	50	25	25	25		
CHIRALPLATE	811057	811059	811055	811058	0.25 mm	UV ₂₅₄

SIL N-HR ^P unmodified standard silica layers

Technical characteristics

- High purity silica 60, mean pore size 60 Å, specific surface (BET) ~ 500 m²/g, specific pore volume 0.75 mL/g, particle size 5 – 17 μm, different binder system compared to SIL G results in different separation characteristics
- A special feature of the POLYGRAM[®] SIL N-HR is a higher gypsum content

POLYGRAM[®] polyester sheets

Plate size [cm]	5 × 20	20 × 20	Thickness of layer	Fluorescent indicator
Pack of [plates]	50	25		
SIL N-HR/UV ₂₅₄	804022	804023	0.20 mm	UV ₂₅₄



Layers for special TLC separations

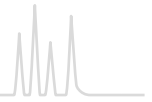

SIL G-25 HR ^G special layer for aflatoxin separation

Technical characteristics

- High purity silica 60 with gypsum and a very small quantity of a polymeric organic binder; softer than the standard silica layer, i.e. spots can be scratched and the layer absorbs faster

Recommended application

- Aflatoxins

Glass plates

Plate size [cm]	20 × 20	Thickness of layer	Fluorescent indicator
Pack of [plates]	25		
SIL G-25 HR	809033	0.25 mm	–
SIL G-25 HR/UV ₂₅₄	809043	0.25 mm	UV ₂₅₄

SIL G-25 Tenside ^G special layer for separation of surfactants

Technical characteristics

- Silica G impregnated with ammonium sulfate

Recommended application

- Detergents, alkanesulfonates, polyglycols

Glass plates

Plate size [cm]	20 × 20	Thickness of layer	Fluorescent indicator
Pack of [plates]	25		
SIL G-25 Tenside	810063	0.25 mm	–

Nano-SIL PAH ^G special HPTLC silica layer for PAH analysis

Technical characteristics

- Nano silica 60, mean pore size 60 Å, specific surface (BET) ~ 500 m²/g, specific pore volume 0.75 mL/g, particle size 2–10 µm
- Impregnated with caffeine, an electron acceptor for PAH analysis based on charge-transfer complexes

Recommended application

- 6 PAHs according to German drinking water specifications (TVO) in accordance with German standard DIN 38407 part 7

Glass plates

Plate size [cm]	10 × 20	Thickness of layer	Fluorescent indicator
Pack of [plates]	50		
Nano-SIL PAH	811051	0.20 mm	–

Further application examples can be found online in our application database at ChromaAppDB.mn-net.com

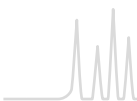

Layers for special TLC separations



IONEX ^P special mixed layers of silica with ion exchange resins

IONEX-25 SA-Na:

- Mixture of silica and a strongly acidic cation exchanger coated to polyester sheets

IONEX-25 SB-AC:

- Mixture of silica and a strongly basic anion exchanger coated to polyester sheets
- Both layers contain an inert organic binder

✓ Recommended application

- Amino acids, e.g., in protein and peptide hydrolyzates, in seeds and fodder, in biological fluids; for racemate separation in peptide syntheses, for the separation of nucleic acid hydrolyzates, aminosugars, amino acids, antibiotics, inorganic phosphates, cations and other compounds with ionic groups

POLYGRAM® polyester sheets

Plate size [cm]		20 × 20	Thickness of layer	Fluorescent indicator
Pack of [plates]		25		
IONEX-25 SA-Na	strongly acidic cation exchanger	806013	0.20 mm	–
IONEX-25 SB-AC	strongly basic anion exchanger	806023	0.20 mm	–

SILCEL-Mix-25 ^G

SILCEL-Mix-25:

- Mixed layer of cellulose and silica, recommended for separation of preservatives and other antimicrobial compounds

✓ Recommended application

- Antimicrobial compounds and preservatives, e.g. benzoic acid

Glass plates

Plate size [cm]	20 × 20	Thickness of layer	Fluorescent indicator
Pack of [plates]	25		
SILCEL-Mix-25 UV ₂₅₄	810043	0.25 mm	UV ₂₅₄

Further application examples can be found online in our application database at ChromaAppDB.mn-net.com

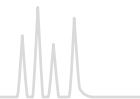

Chromatography papers

Chromatography papers

- Paper chromatography is the oldest chromatographic technique separation due to partition of the analytes between special paper grades and the mobile phase, which penetrates the paper by capillary action ascending.
- Descending and circular techniques are possible

Please note

- Always treat chromatography papers with care
- Never touch them with fingers, because this will contaminate the surface
- Do not bend them sharply, because this will decrease the capillary action (preferably store them flat)

Direction

- Chromatography papers possess a preferred direction of the fibers with higher absorption properties (with our sheets 58 × 60 cm, the longer edge)
- We recommend to use them in the direction of higher absorption

Code	Weight [g/m ²]	Thickness [mm]	Description	Flow rate	Size [cm]	Pack of	REF
MN 214	140	0.28	smooth	90 – 100 mm/30 min	58 × 60	100 sheets	817001
MN 218	180	0.36	smooth	90 – 100 mm/30 min	58 × 60	100 sheets	817002
MN 260	90	0.20	smooth	120 – 130 mm/30 min	58 × 60	100 sheets	817003
MN 261	90	0.18	smooth	90 – 100 mm/30 min	58 × 60	100 sheets	817004
MN 827	270	0.70	soft carton	130 – 140 mm/10 min	58 × 60	100 sheets	817005
MN 866	650	1.70	soft carton	100 – 120 mm/10 min	38 × 38	100 sheets	817006
MN 866	650	1.70	soft carton	100 – 120 mm/10 min	80 × 80	100 sheets	817007
MN 214 ff	140	0.28	MN 214 defatted *	90 – 100 mm/30 min	56 × 58	100 sheets	817008

* This paper is extracted with organic solvents.

For further papers, filters and membranes, feel free to ask for our catalog "Filtration".





Accessories

- Beside ready-to-use layers for thin layer chromatography also accessories are required
- Selection of accessories for reliable separation in TLC

Designation	Pack of	REF
Developing chamber for TLC, 20 × 20 cm	1	814017
Developing chamber for TLC, 10 × 10 cm	1	814016
Simultaneous developing chamber for TLC, 20 × 20 cm	1	814019
Simultaneous developing chamber for TLC, 10 × 10 cm	1	814018
Developing chambers for TLC micro-sets	4	814021
Glass laboratory sprayer with rubber bulb	1	814101
Glass capillaries 1 µL	3 × 50	814022
Rubber caps for capillaries	2	814102
Plastic syringe, 1 mL content with graduation	1	814104
Spotting guides	2	814023
Measuring cylinders, glass, 10 mL content	2	814024
MN ALUGRAM® scissors, ground blade, black handle	1	818666
Filter paper MN 713, 15 × 21 cm	100	814103
Folded filters MN 615 1/4, 11 cm diameter	100	531011
Chromatography paper MN 260, 7.5 × 17 cm (for chamber saturation)	100	814030



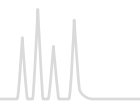

Visualization reagents

- Small selection of frequently used spray reagents for post chromatographic detection reactions in TLC suited for spraying or dipping TLC plates
- A detailed description of many more detection procedures for TLC is available on request

Spray reagent	Solvent	Detection of	Pack of	REF
Aniline phthalate	2-propanol – ethanol (1:1)	reducing sugars, oxohalic acids	100 mL	814919
Bromocresol green	2-propanol	organic acids	100 mL	814920
Reagent for caffeine detection	water – acetone	caffeine	100 mL	814401
2',7'-Dichlorofluorescein	2-propanol	lipids (saturated, unsaturated)	100 mL	814921
4-(Dimethylamino)-benzaldehyde	2-propanol	terpenes, sugars, steroids	100 mL	814922
Reagent according to Dragendorff-Munier	water	alkaloids and other nitrogen compounds	100 mL	814402
Iron(III) chloride	water	phenolic compounds e.g., acetylsalicylic acid, paracetamol	100 mL	814403
Potassium hexacyanoferrate(III)	water	phenolic compounds e.g., acetylsalicylic acid, paracetamol	100 mL	814404
Molybdotophosphoric acid	ethanol	lipids, sterols, steroids, reducing compounds	100 mL	814302
Ninhydrin	ethanol	amino acids, amines and amino sugars	100 mL	814203
Rhodamine B	ethanol	lipids	100 mL	814923
Rubeanic acid	ethanol	heavy metal cations	100 mL	814206

These products contain harmful substances which must be specially labeled as hazardous. For detailed information please see SDS.



Fluorescent indicators

UV indicators with efficient radiation for short-wave as well as long-wave UV ranges

- UV₂₅₄: manganese-activated zinc silicate with absorption maximum at 254 nm, green fluorescence, relatively susceptible towards acids: its fluorescence can be completely quenched by acidic solvents
- UV₃₆₆: inorganic fluorescent pigment with absorption maximum at 366 nm, blue fluorescence

	Composition	Absorption maximum	Color of fluorescence	Pack of 100 g
Fluorescent indicator UV ₂₅₄	manganese-activated zinc silicate	254 nm	green	816710.01
Fluorescent indicator UV ₃₆₆	inorganic fluorescent pigment	366 nm	blue	816720.01



Silica adsorbent for TLC

Pore size 60 Å, pore volume 0.75 mL/g, specific surface (BET) ~ 500 m²/g, pH 7 for a 10 % aqueous suspension

- Silica G: standard grade, particle size 2–20 µm, Fe < 0.02 %, Cl < 0.02 %, 13 % gypsum as binder
- Silica N: standard grade, particle size 2–20 µm, Fe < 0.02 %, Cl < 0.02 %, no binder
- Silica G-HR: high purity grade, particle size 3–20 µm, Fe < 0.002 %, Cl < 0.008 %, gypsum as binder
- Silica P: preparative grade, particle size 5–50 µm, Fe < 0.02 %, Cl < 0.02 %, organic binder
- Silica P with gypsum: preparative grade, particle size 5–50 µm, Fe < 0.02 %, Cl < 0.02 %, gypsum as binder

Designation	Fluorescent indicator	1 kg	5 kg
Silica G	–	816310.1	816310.5
Silica G/UV ₂₅₄	UV ₂₅₄	816320.1	816320.5
Silica N	–	816330.1	816330.5
Silica N/UV ₂₅₄	UV ₂₅₄	816340.1	816340.5
Silica G-HR	–	816410.1	816410.5
Silica P/UV ₂₅₄	UV ₂₅₄	816380.1	816380.5
Silica P/UV ₂₅₄ with gypsums	UV ₂₅₄	816400.1	816400.5

Polyamid adsorbent for TLC

Polyamide 6 = nylon 6 = perlon = ε-polycaprolactame

Designation	Fluorescent indicator	1 kg
Polyamid-DC 6	–	816610.1
Polyamid-DC 6 UV ₂₅₄	UV ₂₅₄	816620.1

Cellulose MN 301 native fibrous cellulose

- Standard grade, fiber length (95 %) 2–20 µm
- Average degree of polymerization 400–500, specific surface acc. to Blaine 15 000 cm²/g
- ≤ 20 ppm Fe, 6 ppm Cu, 7 ppm P, CH₂Cl₂ extract ≤ 0.25 %, residue on ignition at 850 °C ≤ 1500 ppm

Designation	1 kg	5 kg
Cellulose MN 301	816250.1	816250.5

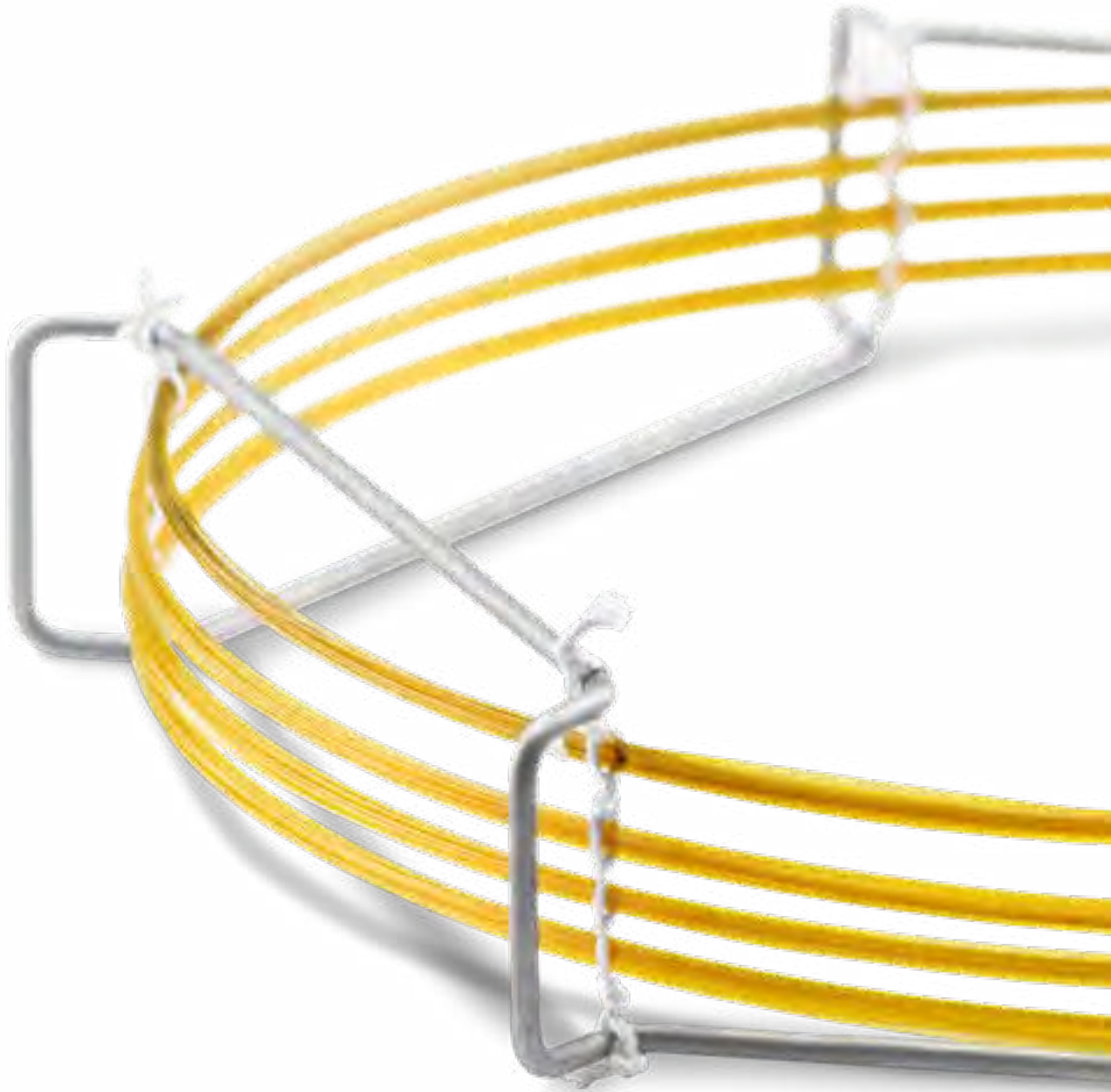
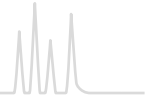



Contents

Basics.....	308
USP listing.....	310
Additional information for GC columns.....	311
Separation properties of OPTIMA® phases.....	313
Summary of MN phases for GC.....	314
OPTIMA® · nonpolar capillary columns.....	318
OPTIMA® · weakly polar capillary columns.....	322
OPTIMA® δ · phases with autoselectivity.....	327
OPTIMA® · medium polar capillary columns.....	329
OPTIMA® · polar capillary columns.....	341
PERMABOND® capillary columns.....	342
Special GC columns overview.....	344
Capillary columns for Fast GC.....	345
Capillary columns for enantiomer separation.....	347
Capillary columns for biodiesel analysis.....	351
Capillary columns for triglyceride analysis.....	353
Capillary columns for high temperature GC.....	354
Capillary columns for amine separation.....	355
Capillary columns for hydrocarbons.....	357
Capillary columns for silane · DEG.....	359
Fused silica capillaries.....	360
Reagents / methods for derivatization.....	362
Reagents / methods for acylation.....	364
Reagents / methods for alkylation / methylation.....	366
Reagents / methods for silylation.....	370
Derivatization procedures.....	372
Test mixtures for GC capillary columns.....	373
Ferrules for capillary columns.....	375
Septa for capillary column.....	376
Accessories for capillary columns.....	377
General accessories.....	378

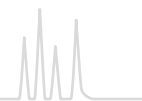

The GC system

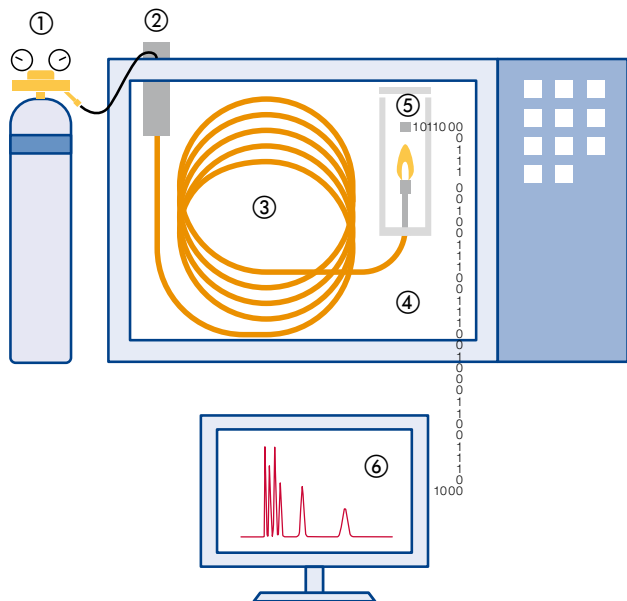

Configuration of a gas chromatograph

- ① Gas supply: carrier gas and – if necessary – detector gases e.g., for FID detector
- ② Sample injector: During direct injection, the sample is applied to the column without touching any other parts made from glass or metal (on-column injection). During indirect injection, the sample is brought into an evaporator and is then transferred onto the column either completely, or partially (split technique). Both techniques allow working at low temperatures, high temperatures and the use of temperature programming.
- ③ Capillary column: the heart of the GC system
- ④ Temperature-controlled oven
- ⑤ Detector: indicates a substance by generating an electrical signal (response). Some detectors are specific for certain classes of substances or for certain elements (e.g., P, N).
- ⑥ Data station for configuration of a gas chromatograph

The separation process

Chromatographic separation is achieved through continuous distribution of each sample component between the mobile and the stationary phase:

In GC, the mobile phase is always a gas, mostly either He, N₂ or H₂.

The stationary phase is often a viscous, gum-like liquid adhered to the inner wall of a capillary column (WCOT = Wall Coated Open Tubular).

Transport of the components occurs exclusively in the mobile phase, while separation only takes place in the stationary phase. The quality of a separation (resolution) depends on the residence time of the components within the stationary phase and on the rate of interactions. The type of interaction between component and phase (selectivity) is determined by the functional groups of the stationary phase. The polarity of the phase is a function of its substituents.

The chromatogram

A chromatogram consists of a base line and a number of peaks. The area of a peak allows quantitative determinations:

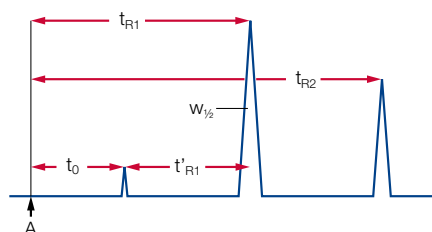

A: starting point of a chromatogram; time of injection of a dissolved solute

A component can be identified by its retention time (qualitative determination):

$$t_{Ri} = t_0 + t'_{Ri}$$

t_0 : dead time; residence time of a solute in the mobile phase (time required by a component to migrate through the chromatographic system without any interaction with the stationary phase)

t_{Ri} : retention time; time interval between peak i and the point of injection

t'_{Ri} : net retention time; difference between total retention time and dead time t_0 . It indicates how long a substance stays in the stationary phase.

Other terms characterizing a separation:

k'_i : retention factor; a measure for the position of a sample peak in the chromatogram. The retention factor is specific for a given compound and constant under constant conditions.

$$k'_i = \frac{t_{Ri} - t_0}{t_0}$$

α : relative retention; also called separation factor or selectivity coefficient, is the ratio of two capacity factors. The reference substance is always in the denominator.

$$\alpha = \frac{k'_2}{k'_1}$$

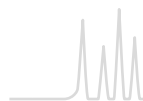

The relative retention does not provide any information on the quality of a separation. For equal values of α two very broad peaks may overlap (as shown in a), or may be completely resolved (as in b), if they are accordingly narrow.

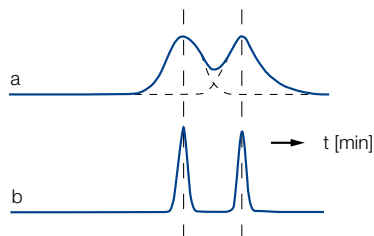

R: resolution; a measure for the quality of a separation, taking ($w_{1/2}$) into account according to:

$$R = 1.18 \cdot \frac{t_{R2} - t_{R1}}{(w_{1/2})_2 + (w_{1/2})_1}$$

N: number of theoretical plates; characterizes the quality of a column (should be determined for $k' > 5$). The height equivalent to a theoretical plate (h , HETP) is calculated by dividing the length L of the column by the number of theoretical plates N . The smaller this value the more efficient the column.

$$N = 5.54 \cdot \frac{(t_{R1})}{(w_{1/2})} \quad h = \text{HETP} = \frac{L}{N}$$

The Golay equation shows how the plate height h depends on the flow velocity u :

B: molecular axial diffusion; B is a function of the diffusion coefficient of the component in the respective carrier gas

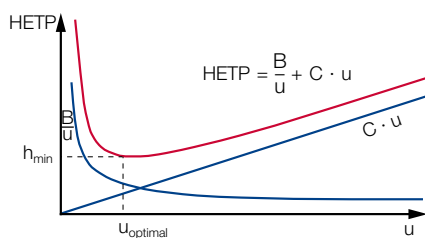

C: resistance to mass transfer

In practice often higher velocities than $u_{opt.}$ are chosen, if separation efficiency is sufficient. Higher carrier velocities mean shorter retention times.

Parameters characterizing a capillary column

OPTIMA® 5	1.0 µm film	30 m ×	0.32 mm ID
A	B	C	D

A: Stationary phase

Different chemical structures of stationary phases are responsible for the type of interaction (selectivity) between the phase and the analytes. The stationary phase also limits the temperature range for chromatography. For a detailed summary of MN phases for GC please see the following chapter.

B: Film thickness

MACHEREY-NAGEL offers ranges from 0.1 to 5.0 µm. The standard film thickness is 0.25 µm. Thin films (0.1–0.2 µm) are very well suited for high-boiling, temperature-sensitive or almost contemporaneously eluting substances.

Increasing the film thickness will increase the capacity, the retention for low-boiling substances and the inertness of the column. This is especially helpful for samples with a broad range of concentrations, or the separation of volatile polar substances.

A better coverage of the column wall by a thicker film and a reduced column surface due to a shorter column have a positive impact on the separation of very active substrates, that may cause noticeable tailing when they come in contact with non-coated spots of the column wall.

Thick films, however, always mean more stationary phase in the column, hence increased column bleeding. Therefore, maximum operating temperatures for thick-film columns are reduced. In addition, thick-film columns may have a lesser separating capacity.

C: Column length

The separating efficiency (better the number of plates N) of a column is directly proportional to its length. Most routine separations are carried out on 25 or 30 m columns, while more complex samples may require 50 or 60 m. 10 m columns are common for Fast GC (see page 345).

D: Inner diameter (ID)

The lower the ID, the higher is the theoretically possible number of plates per meter.

0.1–0.2 mm ID:

for high resolution and short retention times at low carrier gas flow

0.25 mm ID:

for analysis of complex mixtures

0.32 mm ID:

for routine analysis with short retention times, but increased capacity

0.53 mm ID:

for rapid separations with inert surface and highest capacity

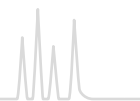

USP listing of MN GC phases

Code	Specifications	MN GC phases	Page
USP G1 / G2	dimethylpolysiloxane oil	OPTIMA® 1	318
		OPTIMA® 1 MS	320
		OPTIMA® 1 MS Accent	320
		OPTIMA® 1-TG	353
		PERMABOND® SE-30	342
		PERMABOND® P-100	357
USP G3	50 % phenyl - 50 % methylpolysiloxane	OPTIMA® 17	335
		OPTIMA® 17 MS	336
		OPTIMA® 17-TG	353
USP G6	trifluoropropylmethylpolysiloxane	OPTIMA® 210	337
USP G7	50 % 3-cyanopropyl – 50 % phenylmethylpolysiloxane	OPTIMA® 225	338
USP G16	polyethylene glycol (average molecular weight ~ 15 000); high molecular weight compound of polyethylene glycol and diepoxide	OPTIMA® WAX	340
		PERMABOND® CW 20 M	342
		PERMABOND® CW 20 M-DEG	359
		FS-CW 20 M-AM	356
USP G19	25 % phenyl – 25 % cyanopropyl – 50 % methylsiloxane	OPTIMA® 225	338
USP G25	high molecular weight compound of polyethylene glycol and diepoxide, which is esterified with terephthalic acid	OPTIMA® FFAP	341
		PERMABOND® FFAP	343
USP G27	5 % phenyl – 95 % methylpolysiloxane	OPTIMA® 5	322
		OPTIMA® 5 Amine	355
		OPTIMA® 5 HT	354
		OPTIMA® 5 MS	323
		OPTIMA® 5 MS Accent	324
USP G28	25 % phenyl – 75 % methylpolysiloxane	OPTIMA® 35 MS	334
USP G32	20 % phenylmethyl – 80 % dimethylpolysiloxane	OPTIMA® 35 MS	334
USP G35	high molecular weight compound of polyethylene glycol and diepoxide, which is esterified with nitroterephthalic acid	OPTIMA® FFAP	341
		PERMABOND® FFAP	343
USP G36	1 % vinyl – 5 % phenylmethylpolysiloxane	OPTIMA® 5	322
		OPTIMA® 5 Amine	355
		OPTIMA® 5 HT	354
		OPTIMA® 5 MS	323
		OPTIMA® 5 MS Accent	324
		PERMABOND® SE-54 HKW	357
USP G38	dimethylpolysiloxane oil	OPTIMA® 1	318
		OPTIMA® 1 MS	320
		OPTIMA® 1 MS Accent	320
		OPTIMA® 1-TG	353
		PERMABOND® SE-30	342
		PERMABOND® P-100	357
USP G42	35 % phenyl – 65 % dimethylpolysiloxane	OPTIMA® 35 MS	334
USP G43	6 % cyanopropylphenyl – 94 % dimethylpolysiloxane	OPTIMA® 1301	329
		OPTIMA® 1301 MS	330
		OPTIMA® 624	330
		OPTIMA® 624 LB	331
USP G46	14 % cyanopropylphenyl – 86 % methylpolysiloxane	OPTIMA® 1701	332
		OPTIMA® 1701 MS	333
USP G49	proprietary derivatized phenyl groups on a polysiloxane backbone	OPTIMA® 8-3	327

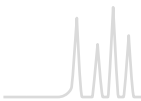

Additional information for GC columns



Scope of delivery

Each column is individually tested and supplied with a test certificate and test chromatogram, but does not include fittings or ferrules. Columns have fused ends or are sealed with septa to protect them from atmospheric oxygen. Further more an instruction leaflet is enclosed.

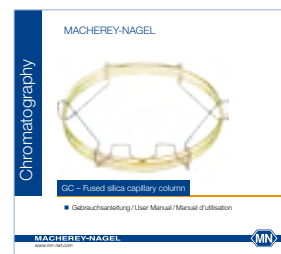
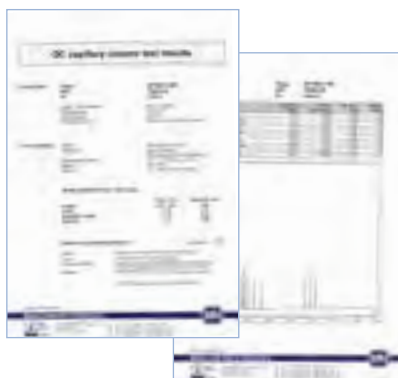
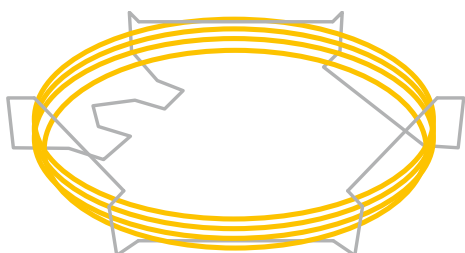

GC cages

The standard size of a GC cage is 7 inches. On request, all columns can be supplied on a 5 inch (13 cm) cage e.g., for the Agilent GC 6850. To order, please add an E at the end of the REF number (e.g., 726470.30E)

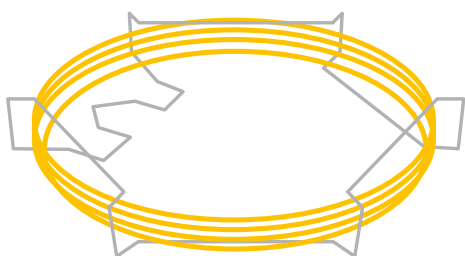

7 inches standard size e.g., REF 726600.30

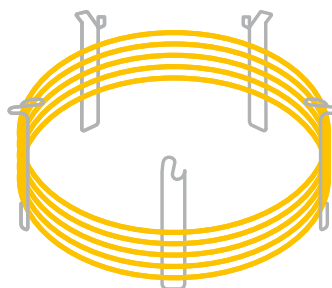

5 inches special cage e.g., REF 726600.30E

Integrated guard column

To prolong column life, even at highly contaminated or matrix-containing samples, MN offers the option to add an integrated guard column. All capillary columns are available with a 10 m guard column with respective deactivation. To order, please add V1 at the end of the REF number (e.g., 726600.30V1). Guard column combinations with other lengths, IDs or different deactivation are available on request.

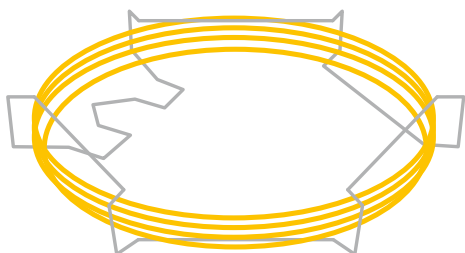

Without integrated guard column e.g., REF 726600.30

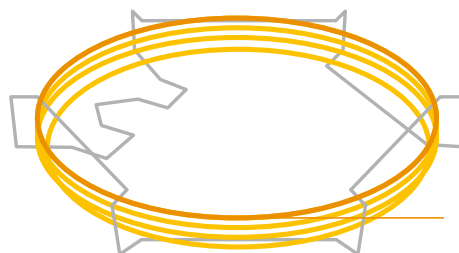

With integrated guard column e.g., REF 726600.30V1

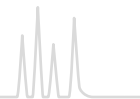

MACHEREY-NAGEL derivatization reagents

Purpose of derivatization

- Improved volatility, better thermal stability or a lower limit of detection in gas chromatography
- Prerequisite: quantitative, rapid and reproducible formation of only one derivative
- Halogen atoms inserted by derivatization (e.g., trifluoroacetates) for specific detection (ECD) with the advantage of high sensitivity
- Influence of elution orders and fragmentation patterns in MS by a specific derivatization
- We provide reagents for
 - Silylation
 - Alkylation (methylation)
 - Acylation
- For 1 × 10 mL, 1 × 50 mL and 6 × 50 mL also as screw neck vial
- Product range from page 362 onwards



Separation properties of OPTIMA® phases

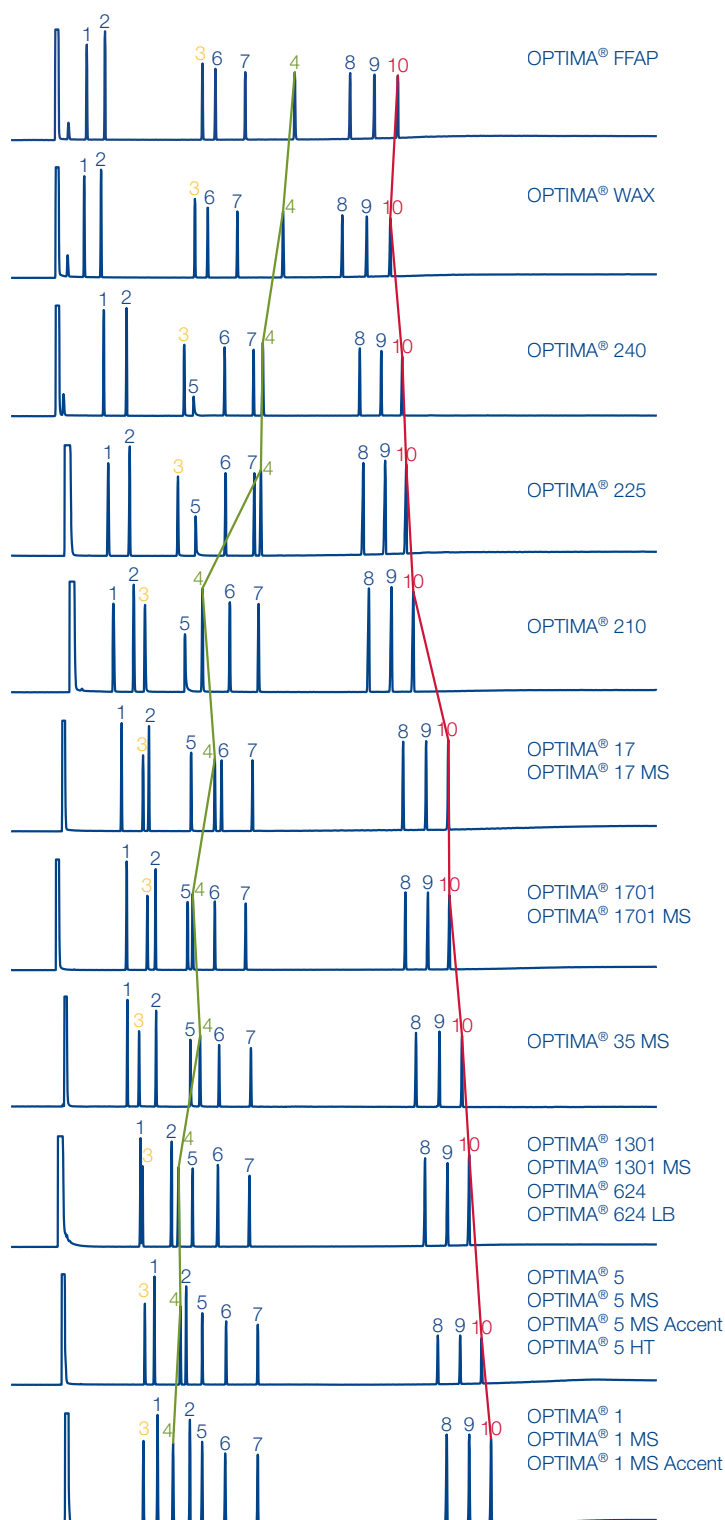

increasing polarity

Peaks:

- | | |
|--------------------|-----------------------|
| 1. Undecane | 6. Methyl decanoate |
| 2. Dodecane | 7. Methyl undecanoate |
| 3. Octanol | 8. Henicosaene |
| 4. Dimethylaniline | 9. Docosane |
| 5. Decylamine | 10. Tricosane |

All columns:

0.25 µm film, 30 m × 0.25 mm ID
 Sample: MN OPTIMA® test mixture (REF 722316)
 Injection: 1.0 µL, split 15 mL/min
 Carrier gas: 0.80 bar He
 Temperature: 80 °C T_{max} (isothermal), 8 °C/min (20 min T_{max})
 Detector: FID 260 – 280 °C



Summary of MN phases for GC

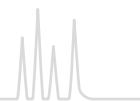

Overview of OPTIMA® MN phases

Phase	Composition	Page	Relative polarity ¹	Maximum temperature ²
OPTIMA® 1	100 % dimethylpolysiloxane	318		340 / 360 °C
OPTIMA® 1 MS	100 % dimethylpolysiloxane	320		
OPTIMA® 1 MS Accent	100 % dimethylpolysiloxane	320		
OPTIMA® 5	5 % phenyl – 95 % methylpolysiloxane	322		340 / 360 °C
OPTIMA® 5 MS	5 % diphenyl – 95 % dimethylpolysiloxane	323		340 / 360 °C
OPTIMA® 5 MS Accent	silarylene phase with selectivity similar to 5 % diphenyl – 95 % dimethylpolysiloxane	324		340 / 360 °C
OPTIMA® XLB	silarylene phase like above, optimized silarylene content for low bleeding	325		340 / 360 °C
OPTIMA® δ-3	phase with autoselectivity ⁴	327		340 / 360 °C
OPTIMA® δ-6	phase with autoselectivity ⁴	328		340 / 360 °C
OPTIMA® 1301	6 % cyanopropylphenyl – 94 % dimethylpolysiloxane	329		300 / 320 °C
OPTIMA® 1301 MS	silarylene phase with low bleeding: polarity similar to 6 % cyanopropylphenyl – 94 % dimethylpolysiloxane	330		300 / 320 °C
OPTIMA® 624	6 % cyanopropylphenyl – 94 % dimethylpolysiloxane	330		280 / 300 °C
OPTIMA® 624 LB	like above, phase with low bleeding	331		
OPTIMA® 1701	14 % cyanopropylphenyl – 86 % dimethylpolysiloxane	332		280 / 300 °C
OPTIMA® 1701 MS	silarylene phase with low bleeding: polarity similar to 14 % cyanopropylphenyl – 86 % dimethylpolysiloxane	333		280 / 300 °C

¹ = nonpolar, = polar

² First temperature (long term temperature) for isothermal operation, second value for the max. temperature (short term temperature) in a temperature program. Please note that for columns with 0.53 mm ID and for columns with thicker films temperature limits are generally lower.

For details refer to the description of individual phases.

³ Phases which provide a similar selectivity based on chemical and physical properties

⁴ See description on page 326

GC columns for special separations can be found from page 344 onwards.

Summary of MN phases for GC



Structure	USP	Similar phases ³
	G1 / G2 / G38	PERMABOND [®] SE-30, OV-1, DB-1, SE-30, HP-1, SPB [™] -1, CP-Sil 5 CB, Rtx [®] -1, 007-1, BP1, MDN-1, AT [™] -1, ZB-1, OV-101 5 % diphenyl – 95 % dimethylpolysiloxane
	G27 / G36	PERMABOND [®] SE-52, SE-54, SE-52, HP-5, SPB [™] -5, CP-Sil 8, Rtx [®] -5, 007-5, BP5, MDN-5, AT [™] -5, ZB-5
	G27 / G36	DB-5, DB-5MS, HP-5MS, Ultra-2, Equity [™] -5, CP-Sil 8CB low bleed/MS, Rxi [®] -5MS, Rtx [®] -5SIL-MS, Rtx [®] -5MS, 007-5MS, BPX [™] 5, MDN-5S, AT [™] -5MS, VF-5MS
	G27 / G36	
	-	DB-XLB, Rxi [®] -XLB, Rtx [®] -XLB, MDN-12, VF-XMS
see description page 326	G49	no similar phases
see description page 326	-	no similar phases
	G43	HP-1301, DB-1301, SPB [™] -1301, Rtx [®] -1301, CP-1301, 007-1301
	G43	VF-1301ms, Rxi [®] -1301Sil MS, TG-1301MS
	G43	HP-624, HP-VOC, DB-624, DB-VRX, SPB [™] -624, CP-624, Rtx [®] -624, Rtx [®] -Volatiles, 007-624, BP624, VOCOL
	G46	OV-1701, DB-1701, CP-Sil 19 CB, HP-1701, Rtx [®] -1701, SPB [™] -1701, 007-1701, BP10, ZB-1701
	G46	VF-1701ms, TG-1701MS, OV-1701, DB-1701, HP-1701, Rtx [®] -1701, SPB [™] -1701, CP Sil 19 CB, 007-1701, BP10, ZB-1701



Summary of MN phases for GC

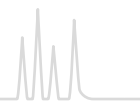

Phase	Composition	Page	Relative polarity ¹	Maximum temperature ²
OPTIMA® 35 MS	silarylene phase with selectivity similar to 35 % diphenyl – 65 % dimethylpolysiloxane	334		360 / 370 °C
OPTIMA® 17	phenylmethylpolysiloxane, 50 % phenyl	335		320 / 340 °C
OPTIMA® 17 MS	silarylene phase with selectivity similar to 50 % phenyl – 50 % methylpolysiloxane	336		340 / 360 °C
OPTIMA® 210	trifluoropropylmethylpolysiloxane (50 % trifluoropropyl)	337		260 / 280 °C
OPTIMA® 225	50 % cyanopropylmethyl – 50 % phenylmethylpolysiloxane	338		260 / 280 °C
OPTIMA® 240	33 % cyanopropylmethyl – 67 % dimethylpolysiloxane	339		260 / 280 °C
OPTIMA® WAX	polyethylene glycol 20 000 Da	340		240 / 250 °C
OPTIMA® FFAP	polyethylene glycol 2-nitroterephthalate	341		250 / 260 °C

¹ = nonpolar, = polar

² First temperature (long term temperature) for isothermal operation, second value for the max. temperature (short term temperature) in a temperature program. Please note that for columns with 0.53 mm ID and for columns with thicker films temperature limits are generally lower. For details refer to the description of individual phases.

³ Phases which provide a similar selectivity based on chemical and physical properties

GC columns for special separations can be found from page 344 onwards.



Summary of MN phases for GC



Structure	USP	Similar phases ³
$\left[\begin{array}{c} \text{C}_6\text{H}_5 \\ \\ \text{---Si---O---} \\ \\ \text{C}_6\text{H}_5 \end{array} \right]_m \left[\begin{array}{c} \text{CH}_3 \\ \\ \text{---Si---} \\ \\ \text{CH}_3 \end{array} \text{---} \text{C}_6\text{H}_4 \text{---} \left[\begin{array}{c} \text{CH}_3 \\ \\ \text{---Si---O---} \\ \\ \text{CH}_3 \end{array} \right]_n \left[\begin{array}{c} \text{CH}_3 \\ \\ \text{---Si---O---} \\ \\ \text{CH}_3 \end{array} \right]_o$	G28 / G32 / G42	DB-35 MS, HP-35, SPB™-35, Rxi®-35SIL MS, Rtx-35, 007-35, BPX™-35, MDN-35, AT™-35 MS, ZB-35, OV-11, VF-35 MS
$\left[\begin{array}{c} \text{CH}_3 \\ \\ \text{O---Si---} \\ \\ \text{C}_6\text{H}_5 \end{array} \right]_m$	G3	OV-17, DB-17, HP-50+, HP-17, SPB™-50, SP-2250, Rxi®-17, Rtx®-50, CP-Sil 24 CB, 007-17, ZB-50
$\left[\begin{array}{c} \text{CH}_3 \\ \\ \text{O---Si---} \\ \\ \text{CH}_3 \end{array} \text{---} \text{C}_6\text{H}_4 \text{---} \left[\begin{array}{c} \text{CH}_3 \\ \\ \text{---Si---} \\ \\ \text{CH}_3 \end{array} \right]_m \left[\begin{array}{c} \text{C}_6\text{H}_5 \\ \\ \text{O---Si---} \\ \\ \text{C}_6\text{H}_5 \end{array} \right]_n$	G3	OV-17, AT™-50, BPX™-50, DB-17, DB-17ms, HP-50+, HP-17, SPB™-50, SPB™-17, SP-2250, Rtx®-50, CP-Sil 24 CB, 007-17, VF-17ms, ZB-50
$\left[\begin{array}{c} \text{CH}_3 \\ \\ \text{O---Si---} \\ \\ \text{F}_3\text{C---(CH}_2)_2 \end{array} \right]_n$	G6	OV-210, DB-210, Rtx®-200, 007-210
$\left[\begin{array}{c} \text{CH}_3 \\ \\ \text{O---Si---} \\ \\ \text{NC---(CH}_2)_3 \end{array} \right]_m \left[\begin{array}{c} \text{CH}_3 \\ \\ \text{O---Si---} \\ \\ \text{C}_6\text{H}_5 \end{array} \right]_n$ <p style="text-align: center;">$m = n$</p>	G7 / G19	DB-225, HP-225, OV-225, Rtx®-225, CP-Sil 43, 007-225, BP225
$\left[\begin{array}{c} \text{CH}_3 \\ \\ \text{O---Si---} \\ \\ \text{NC---(CH}_2)_3 \end{array} \right]_m \left[\begin{array}{c} \text{CH}_3 \\ \\ \text{O---Si---} \\ \\ \text{CH}_3 \end{array} \right]_n$	–	no similar phases
$\text{H} \left[\begin{array}{c} \text{H} \quad \text{H} \\ \quad \\ \text{---O---C---C---} \\ \quad \\ \text{H} \quad \text{H} \end{array} \right]_n \text{OH}$	G16	PERMABOND® CW 20 M, DB-Wax, Supelcowax, HP-Wax, HP-INNOWAX, Rtx-Wax, CP-Wax 52 CB, Stabilwax, 007-CW, BP20, AT-Wax, ZB-Wax
$\left[\begin{array}{c} \text{O} \\ \\ \text{---C---} \\ \\ \text{O}_2\text{N} \end{array} \text{---} \text{C}_6\text{H}_4 \text{---} \begin{array}{c} \text{O} \\ \\ \text{---C---} \\ \\ \text{---(OCH}_2\text{CH}_2)_m\text{---O---} \end{array} \right]_n$	G35 / G25	PERMABOND® FFAP, DB-FFAP, HP-FFAP, CP-Wax 58 FFAP CB, 007-FFAP, CP-FFAP CB, Nukol™, AT-1000, SPB-1000, BP21, OV-351



OPTIMA® · nonpolar capillary columns

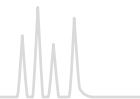

OPTIMA® 1 100 % dimethylpolysiloxane · USP G1 / G2 / G38

★ Key features

- Nonpolar phase
- Structure see page 315

✓ Recommended application

- Separation of components according to boiling points
- Thick film columns $\geq 3 \mu\text{m}$ film are especially recommended for solvent analysis.

✍ Temperature

- Columns with 0.1 – 0.32 mm ID and films $< 3 \mu\text{m}$:
 T_{max} 340 °C (long-term temperature),
 T_{max} 360 °C (short-term max. temperature in a temperature program)
- 0.53 mm ID, films $< 3 \mu\text{m}$:
 T_{max} 320 and 340 °C, resp.
- Thick film columns with films $\geq 3 \mu\text{m}$:
max. temperatures 300 and 320 °C, resp.

Similar phases

- PERMABOND® SE-30 (see page 342), OV-1, DB-1, SE-30, HP-1, SPB™-1, CP-Sil 5 CB, Rtx®-1, 007-1, BP1, MDN-1, AT™-1, ZB-1, OV-101

OPTIMA® 1

	Length → 10 m	12 m	15 m	20 m	25 m	30 m	50 m	60 m
0.1 mm ID (0.4 mm OD)								
0.10 μm film	726024.10			726024.20				
0.40 μm film				726025.20				
0.2 mm ID (0.4 mm OD)								
0.10 μm film					726832.25			
0.20 μm film		726834.12			726834.25		726834.50	
0.35 μm film		726837.12			726837.25		726837.50	
0.50 μm film							726839.50	
0.25 mm ID (0.4 mm OD)								
0.10 μm film	726038.10		726038.15		726038.25	726038.30		726038.60
0.25 μm film	726050.10		726050.15		726050.25	726050.30	726050.50	726050.60
0.50 μm film	726081.10				726081.25	726081.30	726081.50	726081.60
1.00 μm film					726802.25	726802.30	726802.50	726802.60
0.32 mm ID (0.5 mm OD)								
0.10 μm film	726301.10				726301.25	726301.30	726301.50	726301.60
0.25 μm film	726302.10		726302.15		726302.25	726302.30	726302.50	726302.60
0.35 μm film					726821.25	726821.30	726821.50	726821.60
0.50 μm film	726304.10				726304.25	726304.30	726304.50	726304.60
1.00 μm film	726323.10		726323.15		726323.25	726323.30	726323.50	726323.60
3.00 μm film					726805.25	726805.30	726805.50	726805.60
5.00 μm film	726931.10				726931.25	726931.30	726931.50	
0.53 mm ID (0.8 mm OD)								
0.50 μm film			726519.15		726519.25	726519.30		
1.00 μm film	726529.10		726529.15		726529.25	726529.30		
2.00 μm film	726521.10				726521.25	726521.30	726521.50	
5.00 μm film	726926.10				726926.25	726926.30	726926.50	

In addition to this standard program we will be happy to supply columns custom-made to your specifications. Information about scope of delivery, special cages and integrated guard columns see additional information for GC columns on page 311.



OPTIMA® · nonpolar capillary columns



Solvent analysis

MN Appl. No. 201390

Column: OPTIMA® 1, 60 m x 0.32 mm ID, 1.0 µm film
Sample: solvent mixture, courtesy of J. Lutz, Alcan Rorschach, Switzerland
Injection: 0.4 µL, split 1:60
Carrier gas: H₂, 120 kPa
Temperature: 50 °C (9 min) → 90 °C, 4 °C/min → 280 °C (2 min), 14 °C/min
Detector: FID 300 °C

Peaks:

- | | |
|------------------------------------|----------------------------|
| 1. Methanol | 26. Heptanol |
| 2. Ethanol | 27. Ethyl diglycol |
| 3. Acetone | 28. Butyl diglycol |
| 4. 2-Propanol | 29. Butyl glycol acetate |
| 5. Methyl acetate | 30. Butyl diglycol acetate |
| 6. <i>n</i> -Propanol | |
| 7. Methyl ethyl ketone | |
| 8. Ethyl acetate | |
| 9. Isobutanol | |
| 10. <i>n</i> -Butanol | |
| 11. 1-Methoxy-2-propanol | |
| 12. Isooctane | |
| 13. Ethyl glycol | |
| 14. Isoheptane | |
| 15. Methyl isobutyl ketone | |
| 16. 1-Ethoxy-2-propanol | |
| 17. Toluene | |
| 18. Isobutyl acetate | |
| 19. Butyl acetate | |
| 20. 4-Hydroxy-4-methyl-2-pentanone | |
| 21. 1-Methoxy-2-propyl acetate | |
| 22. Xylene | |
| 23. Cyclohexanone | |
| 24. Ethyl glycol acetate | |
| 25. Butyl glycol | |

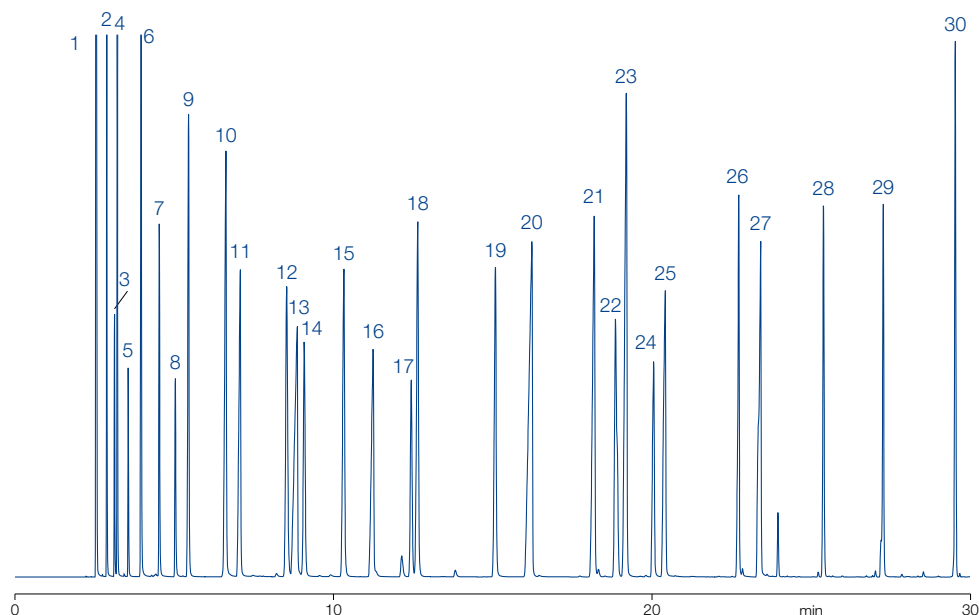



OPTIMA® · nonpolar capillary columns

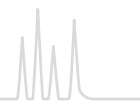

OPTIMA® 1 MS 100 % dimethylpolysiloxane · USP G1 / G2 / G38

★ Key features

- Selectivity identical to OPTIMA® 1,
- Phase with low bleeding
- Structure see page 315

✓ Recommended application

- GC/MS and ECD, general analysis at trace level

✍ Temperature

- T_{max} 340 °C (long-term temperature),
 T_{max} 360 °C (short-term max. temperature in a temperature program)

Similar phases

- Ultra-1, DB-1MS, HP-1MS, Rxi®-1MS, Rtx®-1MS, Equity™-1, AT™-1MS, VF-1MS, CP-Sil 5 CB MS

OPTIMA® 1 MS

	Length → 12 m	15 m	25 m	30 m	50 m	60 m
0.2 mm ID (0.4 mm OD)						
0.20 µm film			726201.25		726201.50	
0.35 µm film	726203.12					
0.25 mm ID (0.4 mm OD)						
0.25 µm film		726205.15		726205.30		726205.60
0.32 mm ID (0.5 mm OD)						
0.25 µm film				726202.30		726202.60

In addition to this standard program we will be happy to supply columns custom-made to your specifications. Information about scope of delivery, special cages and integrated guard columns see additional information for GC columns on page 311.

OPTIMA® 1 MS Accent 100 % dimethylpolysiloxane · USP G1 / G2 / G38

★ Key features

- Selectivity identical to OPTIMA® 1,
- Nonpolar phase
- Lowest column bleed
- Solvent rinsing for removal of impurities applicable
- Increased sensitivity due to an unmatched low background level
- Structure see page 315

✓ Recommended application

- Ideal for ion trap and quadrupole MS detectors
- Perfect inertness for basic compounds
- All-round phase for environmental analysis, trace analysis, EPA methods, pesticides, PCB, food and drug analysis

✍ Temperature

- T_{max} 340 °C (long-term temperature),
 T_{max} 360 °C (short-term max. temperature in a temperature program)

Similar phases

- Ultra-1, DB-1MS, HP-1MS, Rxi®-1MS, Rtx®-1MS, Equity™-1, AT™-1MS, VF-1MS, CP-Sil 5 CB MS



OPTIMA® · nonpolar capillary columns



EPA 8140/8141/8141 A Organophosphorus pesticides

MN Appl. No. 213030

Column: OPTIMA® 1 MS Accent, 30 m x 0.32 mm ID, 0.50 µm film
 Sample: 0.2 µg/mL in hexane,
 8140/8141 OP pesticides calibration mix A
 and 8141 OP pesticides calibration mix B;
 IS triphenyl phosphate and tributyl phosphate
 Injection: 250 °C, splitless (hold 1 min)
 Carrier gas: He, 1 mL/min, constant pressure
 Temperature: 100 °C → 180 °C, 10 °C/min (2 min) → 300 °C, 18 °C/min (3 min)
 Detector: FPD (Flame Photometric Detector), 280 °C

Peaks:

1. Dichlorvos	19. Fonophos	38. Stirofos
2. Hexamethylphospho- ramide	20. Phosphamidon isomer	39. Tokuthion
3. Mevinphos	21. Diazinon	40. Merphos oxidation product
4. Trichlorfon	22. Disulfoton	41. Fensulfothion
5. TEPP	23. Phosphamidon	42. Famphur
6. Thionazin	24. Dichlorofenthion	43. Ethion
7. Demeton-O	25. Parathion-methyl	44. Bolstar
8. Ethoprop	26. Chlorpyrifos-methyl	45. Carbophenothion
9. Tributyl phosphate (IS)	27. Ronnel	46. Triphenyl phosphate (IS)
10. Dicrotophos	28. Fenitrothion	47. Phosmet
11. Monocrotophos	29. Malathion	48. EPN
12. Naled	30. Fenthion	49. Azinphos-methyl
13. Sulfotepp	31. Aspon	50. Leptophos
14. Phorate	32. Parathion-ethyl	51. Tri-o-cresyl phosphate
15. Dimethoate	33. Chlorpyrifos	52. Azinphos-ethyl
16. Demeton-S	34. Trichloronate	53. Coumaphos
17. Dioxathion	35. Chlorfenvinphos	
18. Terbufos	36. Merphos	
	37. Crotoxyphos	

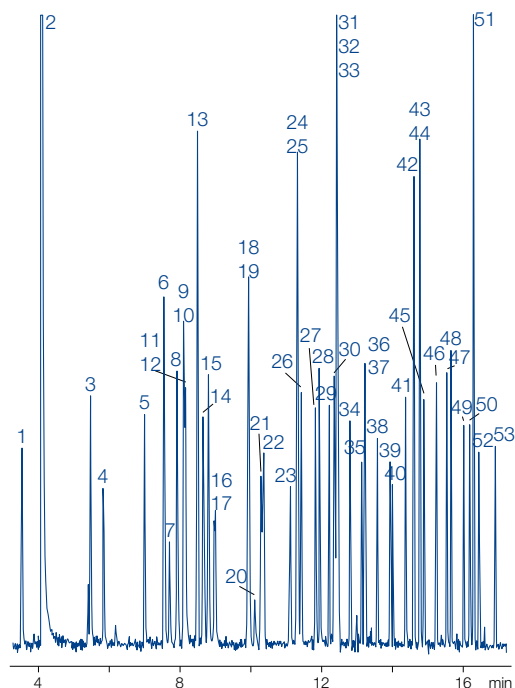

OPTIMA® 1 MS Accent

	Length →				
	15 m	25 m	30 m	50 m	60 m
0.2 mm ID (0.4 mm OD)					
0.20 µm film		725801.25		725801.50	
0.25 mm ID (0.4 mm OD)					
0.25 µm film	725805.15		725805.30		725805.60
0.50 µm film			725806.30		725806.60
0.32 mm ID (0.5 mm OD)					
0.25 µm film			725802.30		725802.60
0.50 µm film			725807.30		725807.60

In addition to this standard program we will be happy to supply columns custom-made to your specifications. Information about scope of delivery, special cages and integrated guard columns see additional information for GC columns on page 311.



OPTIMA® · weakly polar capillary columns

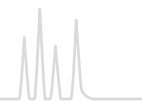

OPTIMA® 5 5 % phenyl – 95 % methylpolysiloxane · USP G27 / G36

★ Key features

- Nonpolar phase
- Structure see page 315

✓ Recommended application

- Standard phase with large range of application

✍ Temperature

- Columns with 0.1 – 0.32 mm ID and films < 3 µm:
T_{max} 340 °C (long-term temperature),
T_{max} 360 °C (short-term max. temperature in a temperature program)
- 0.53 mm ID, films < 3 µm:
T_{max} 320 and 340 °C, resp.
- Thick film columns with films ≥ 3 µm:
max. temperatures 300 and 320 °C, resp.

Similar phases

- PERMABOND® SE-54, SE-52, HP-5, SPB™-5, CP-Sil 8, Rtx®-5, 007 – 5, BP5, MDN-5, AT™-5, ZB-5

OPTIMA® 5

	Length → 10 m	15 m	25 m	30 m	50 m	60 m
0.1 mm ID (0.4 mm OD)						
0.10 µm film	726846.10					
0.2 mm ID (0.4 mm OD)						
0.10 µm film			726854.25			
0.20 µm film			726857.25		726857.50	
0.35 µm film			726860.25		726860.50	
0.50 µm film			726863.25		726863.50	
0.25 mm ID (0.4 mm OD)						
0.10 µm film			726911.25	726911.30	726911.50	726911.60
0.25 µm film	726056.10	726056.15	726056.25	726056.30	726056.50	726056.60
0.35 µm film			726623.25	726623.30	726623.50	726623.60
0.50 µm film			726099.25	726099.30	726099.50	726099.60
1.00 µm film			726807.25	726807.30	726807.50	726807.60
0.32 mm ID (0.5 mm OD)						
0.10 µm film	726313.10	726313.15	726313.25	726313.30	726313.50	726313.60
0.25 µm film		726314.15	726314.25	726314.30	726314.50	726314.60
0.35 µm film			726628.25	726628.30	726628.50	726628.60
0.50 µm film			726316.25	726316.30	726316.50	726316.60
1.00 µm film		726325.15	726325.25	726325.30	726325.50	726325.60
3.00 µm film			726809.25	726809.30	726809.50	726809.60
5.00 µm film		726934.15	726934.25	726934.30	726934.50	
0.53 mm ID (0.8 mm OD)						
0.50 µm film	726523.10		726523.25	726523.30		
1.00 µm film	726541.10	726541.15	726541.25	726541.30		
2.00 µm film	726525.10		726525.25	726525.30	726525.50	726525.60
5.00 µm film	726916.10		726916.25	726916.30	726916.50	

In addition to this standard program we will be happy to supply columns custom-made to your specifications. Information about scope of delivery, special cages and integrated guard columns see additional information for GC columns on page 311.

Further applications can be found online in our application database at ChromaAppDB.mn-net.com



OPTIMA® · weakly polar capillary columns



OPTIMA® 5 MS 5 % diphenyl – 95 % dimethylpolysiloxane · USP G27 / G36

★ Key features

- Selectivity identical to OPTIMA® 5
- Phase with low bleeding
- Structure see page 315

✓ Recommended application

- GC/MS and ECD, applications and general analysis at trace level
- Perfect inertness for basic compounds

✍ Temperature

- T_{max} 340 °C (long-term temperature), T_{max} 360 °C (short-term max. temperature in a temperature program)

Similar phases

- DB-5, DB-5MS, HP-5MS, Ultra-2, Equity™-5, CP-Sil 8CB low bleed/MS, Rxi®-5MS, Rtx®-5SIL-MS, Rtx®-5MS, 007 – 5MS, BPX™5, MDN-5S, AT™-5MS, VF-5MS

Analysis of various phenols

MN Appl. No. 210110

Column: OPTIMA® 5 MS, 30 m x 0.25 mm ID, 0.25 µm film
 Sample: 5 ppm of each compound except *N*-*i*-propylaniline (9.4 ppm)
 Methode: SPME
 Temperature: 40 °C (2 min) → 240 °C, 6 °C/min → 320 °C, 20 °C/min
 Detector: MSD

Peaks:

1. Toluene-D₈
2. Phenol
3. 2-Methylphenol (o-Cresol)
4. Nitrobenzene-D₅
5. *N*-*i*-Propylaniline
6. 2,4-Dichlorophenol
7. 4-Chlorophenol
8. 4-Bromo-2-chlorophenol
9. 3-Bromophenol
10. 4-Chloro-3-methylphenol
11. 2,4-Dibromophenol
12. 2-Hydroxybiphenyl
13. 2-Cyclohexylphenol
14. Hexafluorobisphenol A

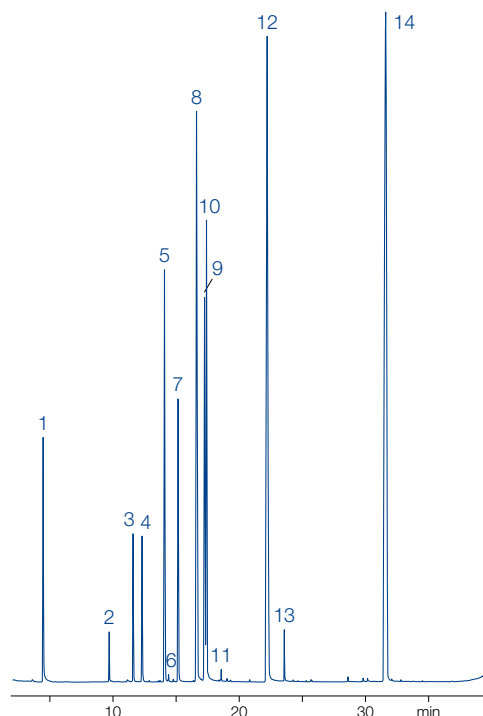

Courtesy of Riedel-de-Haën, Seelze, Germany

OPTIMA® 5 MS

	Length →					
	12 m	15 m	25 m	30 m	50 m	60 m
0.2 mm ID (0.4 mm OD)						
0.20 µm film	726210.12		726210.25		726210.50	
0.35 µm film	726215.12		726215.25		726215.50	
0.25 mm ID (0.4 mm OD)						
0.25 µm film		726220.15		726220.30		726220.60
0.50 µm film				726225.30		726225.60
1.00 µm film				726226.30		726226.60
0.32 mm ID (0.5 mm OD)						
0.25 µm film				726211.30		
0.50 µm film				726213.30		
1.00 µm film			726212.25		726212.50	726212.60

In addition to this standard program we will be happy to supply columns custom-made to your specifications. Information about scope of delivery, special cages and integrated guard columns see additional information for GC columns on page 311.



OPTIMA® · weakly polar capillary columns

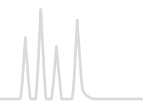

OPTIMA® 5 MS Accent silarylene phase · USP G27 / G36

★ Key features

- Chemically bonded, cross-linked silarylene phase with polarity similar to a 5 % diphenyl–95 % dimethylpolysiloxane phase
- Lowest column bleed, nonpolar phase, solvent rinsing for removal of impurities applicable
- Structure see page 315

✓ Recommended application

- Ideal for ion trap and quadrupole MS detectors
- Perfect inertness for basic compounds
- All-round phase for environmental analysis, trace analysis, EPA methods, pesticides, PCB, food and drug analysis

✍ Temperature

- T_{max} 340 °C (long-term temperature), T_{max} 360 °C (short-term max. temperature in a temperature program)
- Film thickness > 0.5 µm: T_{max} 320 and 340 °C, resp.

Similar phases

- DB-5, DB-5MS, HP-5MS, Ultra-2, Equity™-5, CP-Sil 8CB low bleed/MS, Rxi®-5MS, Rtx®-5SIL-MS, Rtx®-5MS, 007-5MS, BPX™5, MDN-5S, AT™-5MS, VF-5MS

Increased sensitivity due to an unmatched low background level

The bleed comparison test of OPTIMA® 5 MS Accent with a conventional 5 MS phase shows the outstanding performance of the silarylene phase.

The unmatched low background level of the OPTIMA® 5 MS Accent (approximately three times lower compared to a 5 MS brand column) provides significantly increased sensitivity, allowing its application in trace analysis of particularly high-boiling compounds.

Background noise at 340 °C

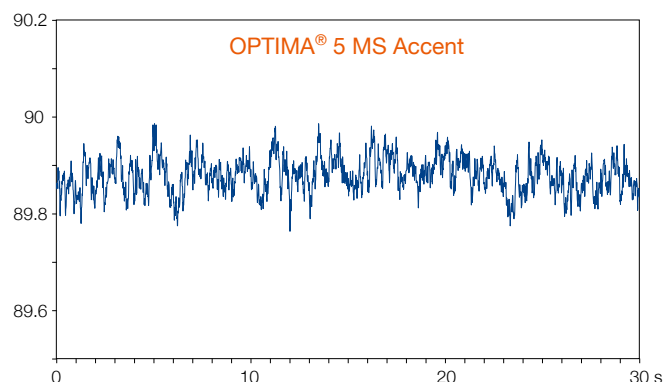
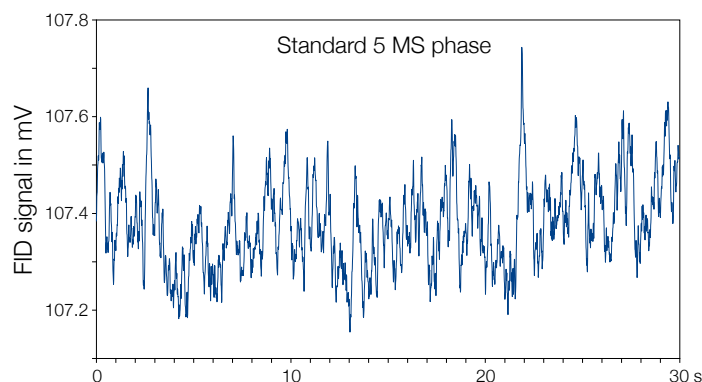

OPTIMA® 5 MS Accent

	Length → 12 m	15 m	25 m	30 m	50 m	60 m
0.20 mm ID (0.4 mm OD)						
0.20 µm film			725810.25		725810.50	
0.35 µm film	725815.12				725815.50	
0.25 mm ID (0.4 mm OD)						
0.25 µm film		725820.15		725820.30		725820.60
0.50 µm film				725825.30		725825.60
1.00 µm film				725826.30		725826.60
0.32 mm ID (0.5 mm OD)						
0.25 µm film				725811.30		725811.60
0.50 µm film				725813.30		
1.00 µm film			725812.25			725812.60

In addition to this standard program we will be happy to supply columns custom-made to your specifications. Information about scope of delivery, special cages and integrated guard columns see additional information for GC columns on page 311.



OPTIMA® · weakly polar capillary columns



OPTIMA® XLB silarylene phase

★ Key features

- Chemically bonded, cross-linked silarylene phase, optimized silarylene content for lowest column bleed, nonpolar phase, perfect inertness for basic compounds, solvent rinsing for removal of impurities applicable
- Structure see page 315

Similar phases

- DB-XLB, Rxi®-XLB, Rtx®-XLB, MDN-12, VF-XMS

✓ Recommended application

- Ideal for ion trap and quadrupole MS detectors, ultra low bleed phase, highly selective for environmental and trace analysis, pesticides, recommended phase for PCB separations

✍ Temperature

- T_{max} 340 °C (long-term temperature), T_{max} 360 °C (short-term max. temperature in a temperature program)

Rapid separation of PCB and PAH

MN Appl. No. 212920

Column: OPTIMA® XLB, 30 m x 0.25 mm ID, 0.25 µm film
 Injection: 1 µL, Standard 0.005 ng/µL, 250 °C, pulsed, splitless, pulse 1.38 bar in 1 min
 Carrier gas: 60 mL/min He
 Temperature: 40 °C (2 min) → 240 °C (2 min), 30 °C/min → 340 °C (5 min), 10 °C/min
 Detektion: MS source 230 °C, interface 280 °C, quadrupole 150 °C

Peaks:	21. Benz[a]anthracene
1. Naphthalene	22. Chrysene
2. 2-Methylnaphthalene	23. PCB-169
3. Acenaphthylene	24. PCB-194
4. Acenaphthene	25. Benzo[b]fluoranthene
5. Fluorene	26. Benzo[k]fluoranthene
6. Phenanthrene	27. Benzo[a]pyrene
7. Anthracene	28. Dibenz[ah]anthracene
8. PCB-31	29. Indeno[1,2,3-cd]pyrene
9. PCB-28	30. Benzo[ghi]perylene
10. PCB-52	
11. Fluoranthene	
12. PCB-101	
13. Pyrene	
14. PCB-77	
15. 2-Methylfluoranthene	
16. PCB-118	
17. PCB-153	
18. PCB-138	
19. PCB-126	
20. PCB-180	

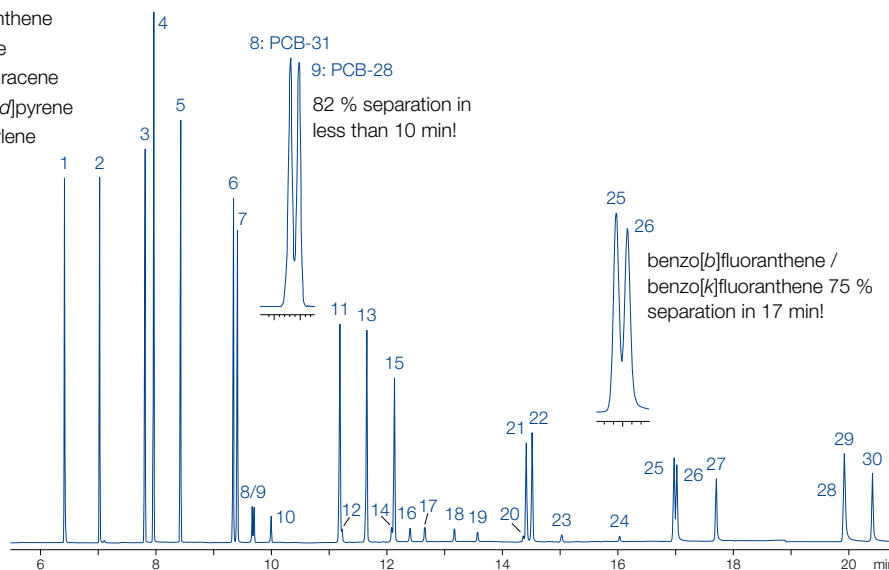

Courtesy of Centre d'Analyses de Recherche, Lab. d'Hydrologie, 65400 Illkirch, France

OPTIMA® XLB

	Length → 30 m	60 m
--	------------------	------

0.25 mm ID (0.4 mm OD)

0.25 µm film

725850.30

725850.60

In addition to this standard program we will be happy to supply columns custom-made to your specifications. Information about scope of delivery, special cages and integrated guard columns see additional information for GC columns on page 311.

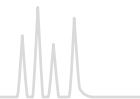

Range of polarities covered by OPTIMA® δ phases

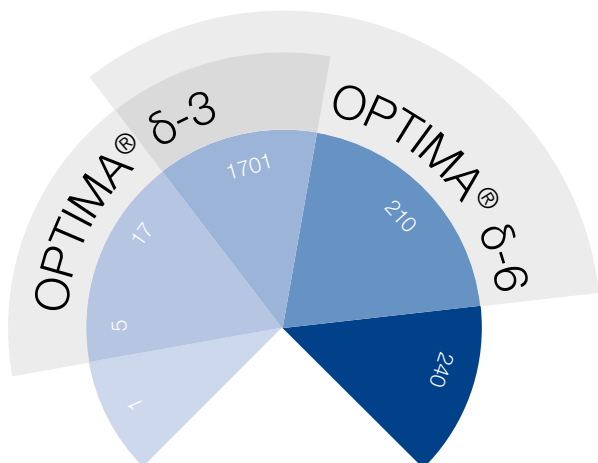

All stationary GC phases can be classified by their polarities. While the selectivity of common GC phases is generally determined by permanent dipole-dipole interactions, OPTIMA® δ -3 and OPTIMA® δ -6 show an additional feature. Large, polarizable groups in the polymer chain of the stationary phase enable the analyte to induce a further dipole moment that increases

with the polarity of said analyte. We call this phenomenon “Autoselectivity”, because the column adjusts itself to the polarity of the analyte. The implemented polymers consist of cross-linked polysiloxanes with a defined composition and an extremely narrow distribution of molecular weight.

OPTIMA® δ phases cover broad ranges of polarities. Compared with conventional phases, OPTIMA® δ -3 polarity ranges from approximately the nonpolar OPTIMA® 5 to the midpolar OPTIMA® 1701, while for OPTIMA® δ -6 the polarity covers a range from about the midpolar OPTIMA® 17 to the polar OPTIMA® 210.

OPTIMA® δ phases show high temperature limits (340 / 360 °C), as well as low bleed levels, which makes them ideal for the use with mass selective (MSD) or phosphorus/nitrogen detectors (PND) in the field of environmental trace analysis.

Isomeric phenols, such as chloro- and nitrophenols, are difficult to analyze with standard GC phases (e.g., OPTIMA® 5 or OPTIMA® 17) because of co-elutions. The autoselective OPTIMA® δ -3 is able to separate all 22 phenols due to stronger interactions occurring with more polar molecules, because polar analytes induce a dipole moment in the phase of the OPTIMA® δ -3 (see chromatogram page 327).

Separation characteristics of OPTIMA® δ phases

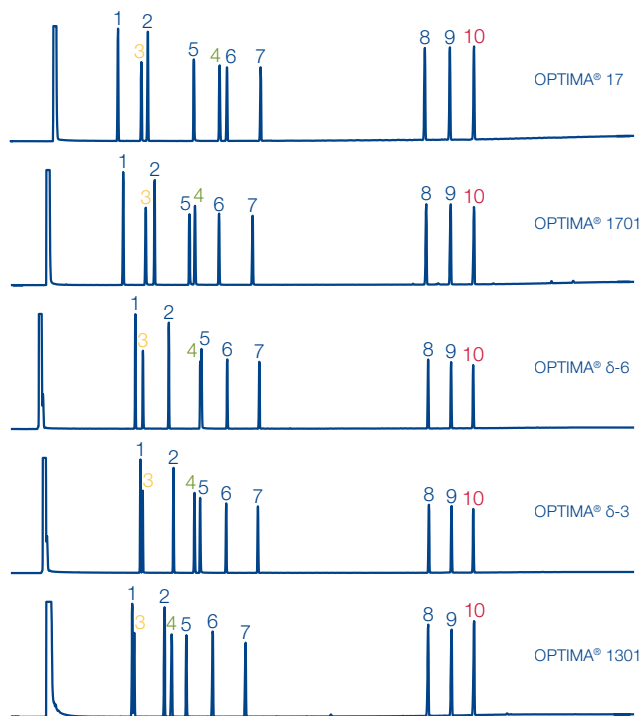

Conditions and peaks (see page 313)

Key features of OPTIMA® δ phases

- Wide range of application due to autoselectivity
- Outstanding thermal stability similar to nonpolar phases
- Low bleed levels
- Medium polar without CN groups

Ordering information about OPTIMA® δ phases can be found on page 327 and page 328.



OPTIMA[®] δ-3 polysiloxane phase with autoselectivity · USP G49

★ Key features

- Medium polar without CN groups
- Autoselectivity resulting in a polarity range from approximately the nonpolar OPTIMA[®] 5 to the midpolar OPTIMA[®] 1701 (see page 326)
- Analytes determine the polarity of the phase

✓ Recommended application

- Ideal for MSD and PND detectors

✍ Temperature

- 0.1 – 0.32 mm ID:
 - T_{max} 340 °C (long-term temperature),
 - T_{max} 360 °C (short-term max. temperature in a temperature program)
- 0.53 mm ID:
 - T_{max} 320 and 340 °C, resp.

Similar phases

- Exclusively from MN

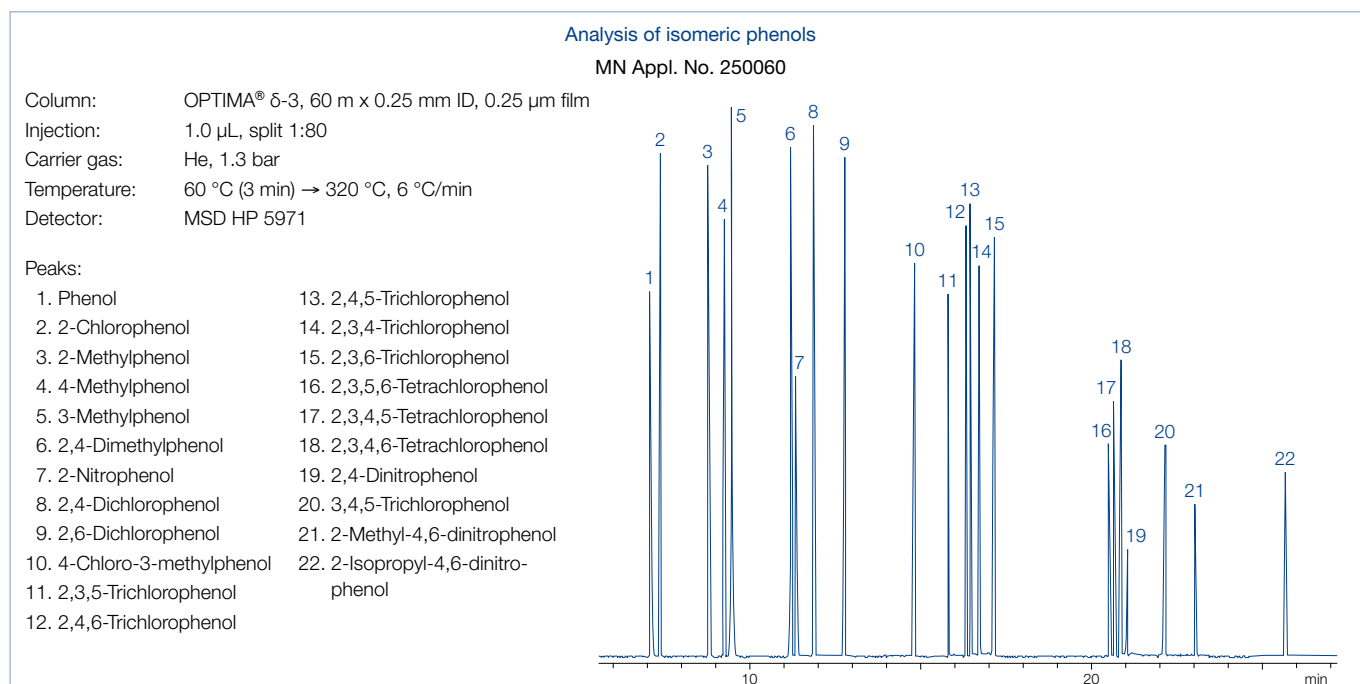

OPTIMA[®] δ-3

	Length →					
	10 m	20 m	25 m	30 m	50 m	60 m
0.1 mm ID (0.4 mm OD)						
0.10 µm film	726410.10	726410.20				
0.2 mm ID (0.4 mm OD)						
0.20 µm film			726400.25		726400.50	
0.25 mm ID (0.4 mm OD)						
0.25 µm film				726420.30		726420.60
0.50 µm film				726421.30		
0.32 mm ID (0.5 mm OD)						
0.25 µm film				726440.30		726440.60
0.35 µm film				726441.30		726441.60
1.00 µm film				726442.30		726442.60
0.53 mm ID (0.8 mm OD)						
1.00 µm film				726443.30		

In addition to this standard program we will be happy to supply columns custom-made to your specifications. Information about scope of delivery, special cages and integrated guard columns see additional information for GC columns on page 311.

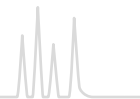

OPTIMA® δ -6 polysiloxane phase with autoselectivity

★ Key features

- Medium polar without CN groups
Autoselectivity resulting in a polarity range from approximately the midpolar OPTIMA® 17 to the polar OPTIMA® 210 (see page 326)
- Analytes determine the polarity of the phase

✓ Recommended application

- Ideal for MSD and PND detectors

✍ Temperature

- 0.1–0.32 mm ID:
T_{max} 340 °C (long-term temperature),
T_{max} 360 °C (short-term max. temperature in a temperature program)
- 0.53 mm ID:
T_{max} 320 and 340 °C, resp.

Similar phases

- Exclusively from MN

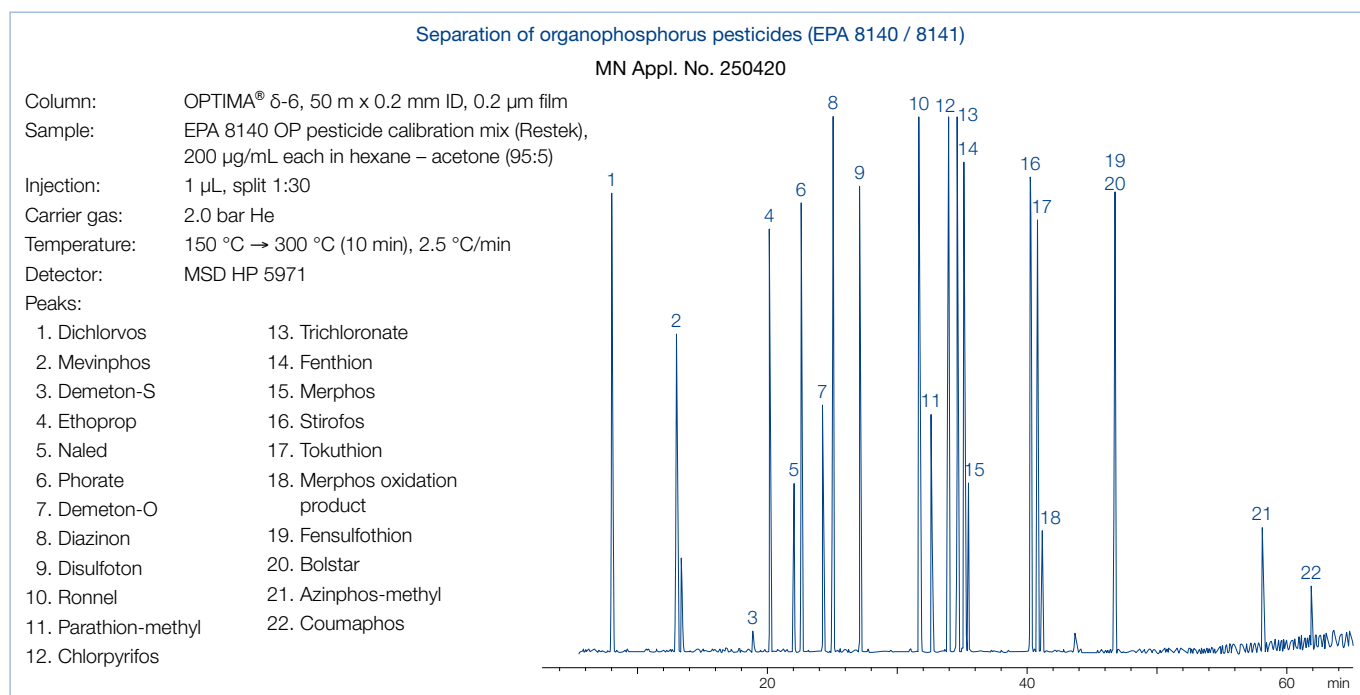

OPTIMA® δ -6

Length →	10 m	25 m	30 m	50 m	60 m
0.1 mm ID (0.4 mm OD)					
0.10 μ m film	726490.10				
0.2 mm ID (0.4 mm OD)					
0.20 μ m film		726465.25		726465.50	
0.25 mm ID (0.4 mm OD)					
0.25 μ m film			726470.30		726470.60
0.32 mm ID (0.5 mm OD)					
0.25 μ m film			726480.30		726480.60
0.35 μ m film			726481.30		726481.60
1.00 μ m film			726482.30		726482.60
0.53 mm ID (0.8 mm OD)					
1.00 μ m film			726483.30		

In addition to this standard program we will be happy to supply columns custom-made to your specifications. Information about scope of delivery, special cages and integrated guard columns see additional information for GC columns on page 311.



OPTIMA[®] 1301 6 % cyanopropyl-phenyl – 94 % dimethylpolysiloxane · USP G43

★ Key features

- Midpolar phase
- Structure see page 315

✓ Recommended application

- Pesticide analysis
- For corresponding columns with higher film thickness see OPTIMA[®] 624

✍ Temperature

- T_{max} 300 °C (long-term temperature), T_{max} 320 °C (short-term max. temperature in a temperature program)

Similar phases

- HP-1301, DB-1301, SPB[™]-1301, Rtx[®]-1301, CP-1301, 007-1301

Analysis of a pesticide mixture

MN Appl. No. 210620

Column: OPTIMA[®] 1301, 60 m x 0.25 mm ID, 0.25 µm film
 Injection: 3 µL (0.1 ng/µL), 80 °C (1 min) → 250 °C (1 min) pulsed splitless
 Carrier gas: He, 54 mL/min
 Temperature: 80 °C (2 min) → 190 °C, 20 °C/min (12 min) → 240 °C, 2 °C/min (23 min) → 260 °C, 10 °C/min (20 min)
 Detector: ECD

Peaks :

1. Propyzamide
2. Vinclozolin
3. Bromophos-ethyl
4. 2,4-DDT
5. Brompropylate

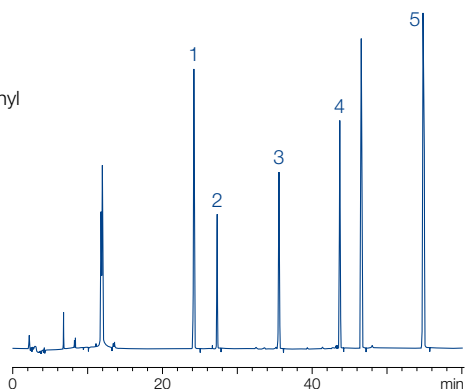

Analysis of a PCB mixture

MN Appl. No. 210650

Column: OPTIMA[®] 1301, 60 m x 0.25 mm ID, 0.25 µm film
 Injection: 3 µL (0.1 ng/µL), 80 °C (1 min) → 250 °C (1 min) pulsed splitless
 Carrier gas: He, 54 mL/min
 Temperature: 80 °C (2 min) → 190 °C, 20 °C/min (12 min) → 240 °C, 2 °C/min (23 min) → 260 °C, 10 °C/min (20 min)
 Detector: ECD

Peaks :

1. PCB-28
2. PCB-52
3. PCB-128
4. PCB-153
5. PCB-138
6. PCB-180

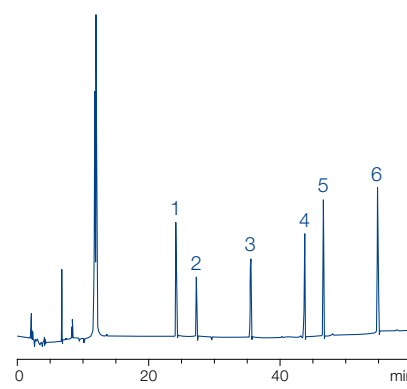

OPTIMA[®] 1301

	Length → 25 m	30 m	50 m	60 m
0.25 mm ID (0.4 mm OD)				
0.25 µm film	726771.25	726771.30	726771.50	726771.60
0.32 mm ID (0.5 mm OD)				
0.25 µm film	726777.25	726777.30		726777.60
1.00 µm film		726780.30	726780.50	726780.60
0.53 mm ID (0.8 mm OD)				
1.00 µm film	726783.25			

In addition to this standard program we will be happy to supply columns custom-made to your specifications. Information about scope of delivery, special cages and integrated guard columns see additional information for GC columns on page 311.

Further applications can be found online in our application database at ChromaAppDB.mn-net.com

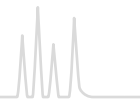

OPTIMA® 1301 MS 6 % cyanopropyl-phenyl – 94 % dimethylpolysiloxane · USP G43

★ Key features

- Chemically bonded, cross-linked silarylene phase with selectivity similar to 6 % cyanopropyl-phenyl – 94 % dimethylpolysiloxane, symmetric substituted cyanopropylsilanes and integrated phenyl rings (silarylene)
- Midpolar phase with very low bleed
- Perfect deactivation
- Structure see page 315

Similar phases

- VF-1301ms, Rxi®-1301Sil MS, TG-1301MS

✓ Recommended application

- Specially suitable for sophisticated environmental analysis (e.g., EPA methods for PAHs, PCBs and pesticides)
- 100 % ion trap and quadrupole MS compatibility

✍ Temperature

- T_{max} 300 °C (long-term temperature), T_{max} 320 °C (short-term max. temperature in a temperature program)

OPTIMA® 1301 MS

	Length →	
	30 m	60 m
0.25 mm ID (0.4 mm OD)		
0.25 µm film	726640.30	726640.60
0.32 mm ID (0.5 mm OD)		
0.25 µm film	726641.30	726641.60
1.00 µm film	726642.30	726642.60
0.53 mm ID (0.8 mm OD)		
1.00 µm film	726643.30	726643.60

In addition to this standard program we will be happy to supply columns custom-made to your specifications. Information about scope of delivery, special cages and integrated guard columns see additional information for GC columns on page 311.

OPTIMA® 624 6 % cyanopropyl-phenyl – 94 % dimethylpolysiloxane · USP G43

★ Key features

- Midpolar phase
- Structure see page 315

✓ Recommended application

- Environmental analysis
- For corresponding columns with lower film thickness see OPTIMA® 1301

✍ Temperature

- T_{max} 280 °C (long-term temperature), T_{max} 300 °C (short-term max. temperature in a temperature program)

Similar phases

- HP-624, HP-VOC, DB-624, DB-VRX, SPB™-624, CP-624, Rtx®-624, Rtx®-Volatiles, 007-624, BP624, VOCOL



OPTIMA® 624 LB 6 % cyanopropyl-phenyl – 94 % dimethylpolysiloxane

★ Key features

- Midpolar phase with low bleeding
- Structure see page 315

✓ Recommended application

- Halogenated hydrocarbons, volatiles, aromatic compounds, solvents etc.

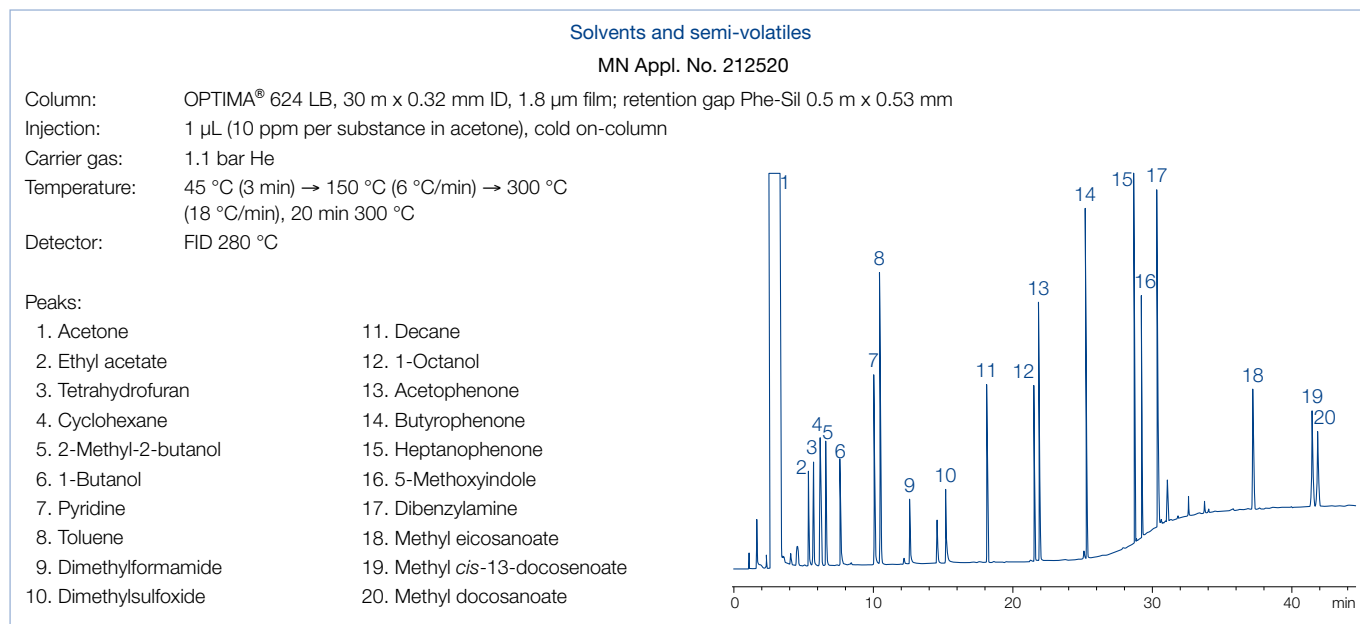

OPTIMA® 624

	Length →			
	25 m	30 m	50 m	60 m
0.2 mm ID (0.4 mm OD)				
1.10 µm film	726784.25			
0.25 mm ID (0.4 mm OD)				
1.40 µm film	726785.25	726785.30	726785.50	726785.60
0.32 mm ID (0.5 mm OD)				
1.80 µm film	726787.25	726787.30	726787.50	726787.60
0.53 mm ID (0.8 mm OD)				
3.00 µm film	726789.25	726789.30		

OPTIMA® 624 LB

	Length →		
	25 m	30 m	50 m
0.32 mm ID (0.5 mm OD)			
1.80 µm film		726786.30	726786.50

In addition to this standard program we will be happy to supply columns custom-made to your specifications. Information about scope of delivery, special cages and integrated guard columns see additional information for GC columns on page 311.



OPTIMA® · medium polar capillary columns

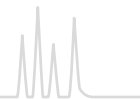

OPTIMA® 1701 14 % cyanopropyl-phenyl – 86 % dimethylpolysiloxane · USP G46

★ Key features

- Midpolar phase, special selectivity due to high cyanopropyl content
- Structure see page 315

✓ Recommended application

- Reference column for structure identification, e.g., in combination with OPTIMA® 5
- Film thickness $\geq 1 \mu\text{m}$ for solvent analysis

✍ Temperature

- T_{max} 280 °C (long-term temperature), T_{max} 300 °C (short-term max. temperature in a temperature program)
- 0.53 mm ID: T_{max} 280 and 300 °C, resp.

Similar phases

- OV-1701, DB-1701, CP-Sil 19 CB, HP-1701, Rtx®-1701, SPB™-1701, 007-1701, BP10, ZB-1701

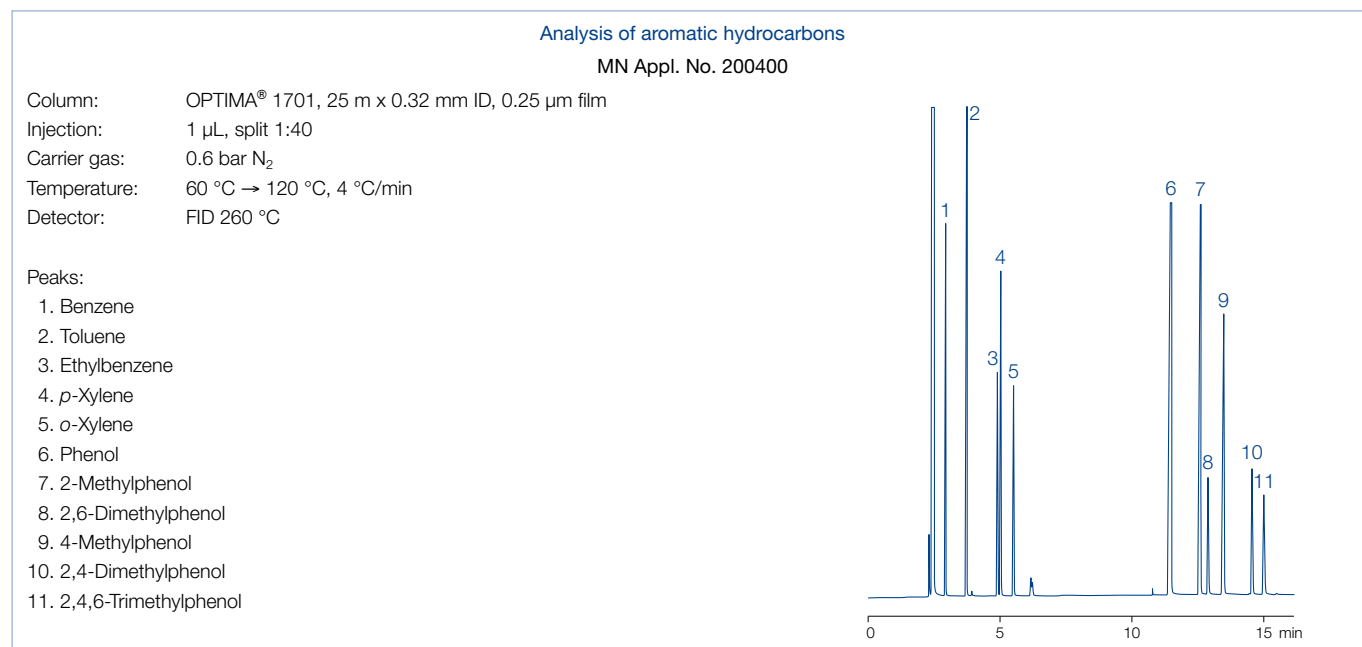

OPTIMA® 1701

	Length \rightarrow					
	10 m	15 m	25 m	30 m	50 m	60 m
0.2 mm ID (0.4 mm OD)						
0.20 μm film			726841.25		726841.50	
0.25 mm ID (0.4 mm OD)						
0.25 μm film	726058.10	726058.15	726058.25	726058.30	726058.50	726058.60
0.50 μm film				726064.30		726064.60
1.00 μm film				726965.30		
0.32 mm ID (0.5 mm OD)						
0.25 μm film	726318.10	726318.15	726318.25	726318.30	726318.50	726318.60
0.35 μm film			726824.25	726824.30	726824.50	726824.60
0.50 μm film			726320.25	726320.30	726320.50	726320.60
1.00 μm film			726929.25	726929.30	726929.50	726929.60
0.53 mm ID (0.8 mm OD)						
1.00 μm film	726545.10	726545.15	726545.25	726545.30		
2.00 μm film		726735.15	726735.25	726735.30	726735.50	

In addition to this standard program we will be happy to supply columns custom-made to your specifications. Information about scope of delivery, special cages and integrated guard columns see additional information for GC columns on page 311.

Further applications can be found online in our application database at ChromaAppDB.mn-net.com



OPTIMA® · medium polar capillary columns



OPTIMA® 1701 MS silarylene phase · USP G46

★ Key features

- Chemically bonded, cross-linked silarylene phase with selectivity similar to 14 % cyanopropyl-phenyl – 86 % dimethylpolysiloxane, symmetric substituted cyanopropylsilanes and integrated phenyl rings (silarylene)
- Midpolar phase with very low bleed
- Perfect deactivation
- Structure see page 315

✓ Recommended application

- Environmental analysis (e.g., PAHs, PCBs, pesticides)
- Reference column for structure identification, e.g., in combination with OPTIMA® 5 MS
- 100 % ion trap and quadrupole MS compatibility

✍ Temperature

- T_{max} 280 °C (long-term temperature), T_{max} 300 °C (short-term max. temperature in a temperature program)

Similar phases

- VF-1701ms, TG-1701MS, OV-1701, DB-1701, HP-1701, Rtx®-1701, SPB™-1701, CP Sil 19 CB, 007-1701, BP10, ZB-1701

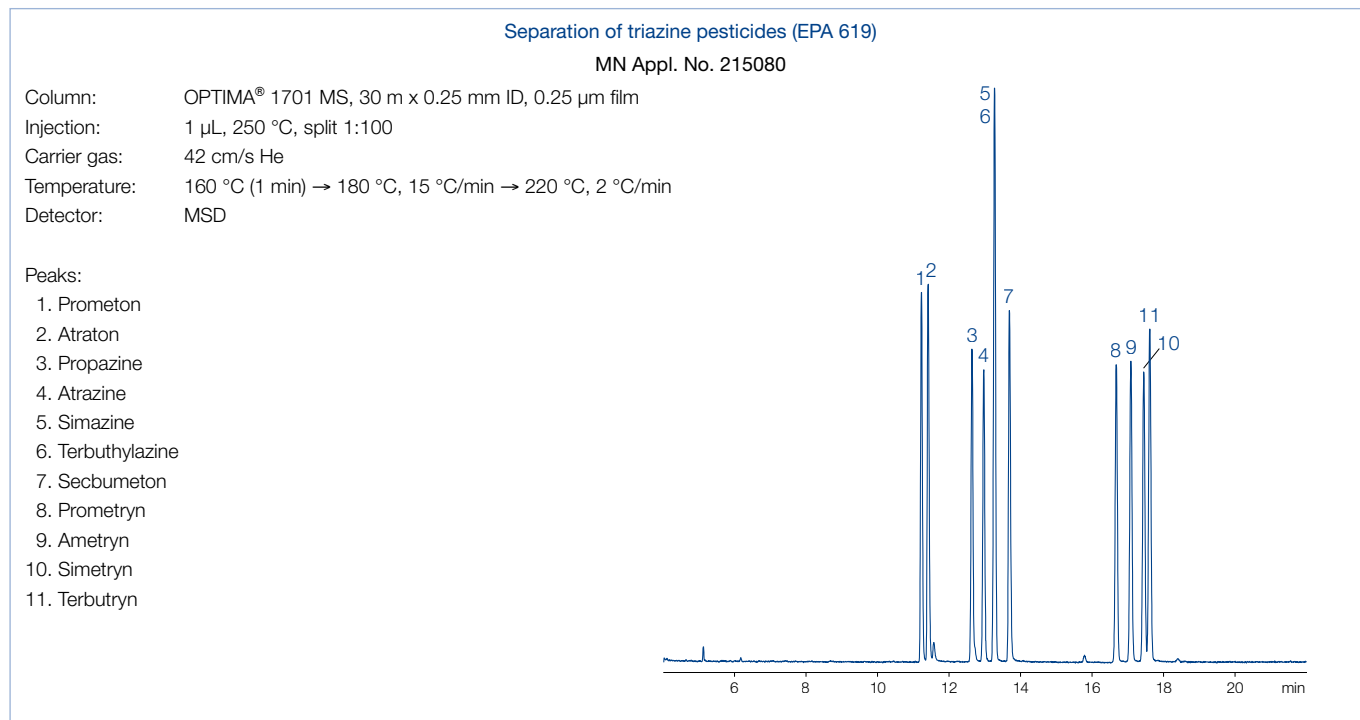

OPTIMA® 1701 MS

	Length → 30 m	60 m
0.25 mm ID (0.4 mm OD)		
0.25 µm film	726630.30	726630.60
0.50 µm film	726631.30	726631.60
0.32 mm ID (0.5 mm OD)		
0.25 µm film	726633.30	726633.60
0.50 µm film	726634.30	726634.60

In addition to this standard program we will be happy to supply columns custom-made to your specifications. Information about scope of delivery, special cages and integrated guard columns see additional information for GC columns on page 311.



OPTIMA® · medium polar capillary columns

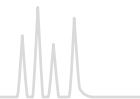

OPTIMA® 35 MS silylene phase · USP G42 / close equivalent to USP G28 / G32

★ Key features

- Chemically bonded cross-linked silylene phase with selectivity similar to 35 % phenyl – 65 % methyl polysiloxane, midpolar phase, polymer without CN groups
- Very low column bleeding
- Structure see page 317

✓ Recommended application

- Ideal for ion trap detectors
- Optimum column for confirmation of analytical results in combination with a 1 MS or 5 MS
- All-round phase for environmental analysis, ultra trace analysis, EPA methods, pesticides, PCB, food and drug analysis

✍ Temperature

- T_{max} 360 °C (long-term temperature), T_{max} 370 °C (short-term max. temperature in a temperature program)

Similar phases

- DB-35 MS, HP-35, SPB™-35, Rxi®-35SIL MS, Rtx-35, 007-35, BPX™-35, MDN-35, AT™-35 MS, ZB-35, OV-11, VF-35 MS

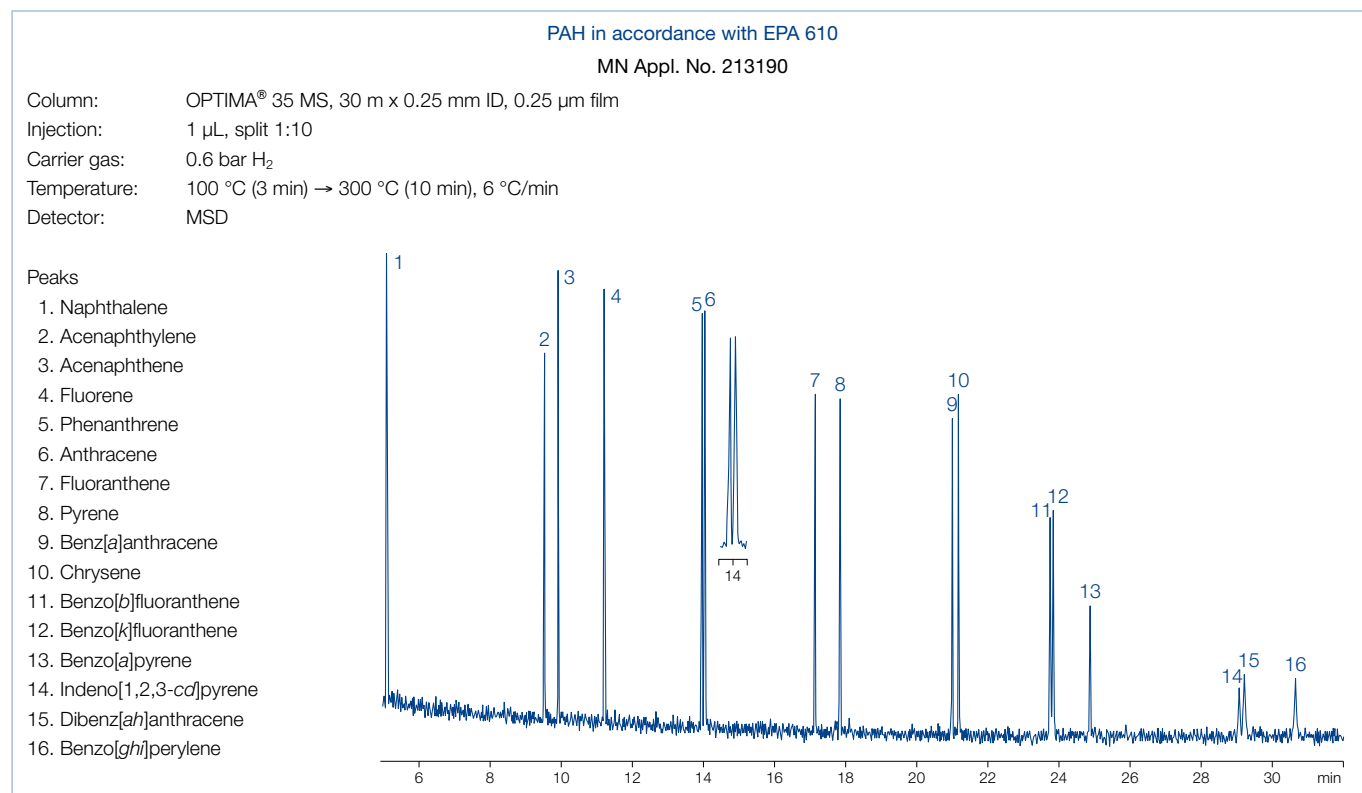

OPTIMA® 35 MS

	Length → 30 m	60 m
0.25 mm ID (0.4 mm OD)		
0.25 µm film	726154.30	726154.60
0.32 mm ID (0.5 mm OD)		
0.25 µm film	726157.30	726157.60

In addition to this standard program we will be happy to supply columns custom-made to your specifications. Information about scope of delivery, special cages and integrated guard columns see additional information for GC columns on page 311.

Further applications can be found online in our application database at ChromaAppDB.mn-net.com



OPTIMA[®] 17 phenylmethylpolysiloxane (50 % phenyl) · USP G3

★ Key features

- Midpolar phase
- Structure see page 317

✓ Recommended application

- Steroids, pesticide, drug analysis

✍ Temperature

- T_{max} 320 °C (long-term temperature), T_{max} 340 °C (short-term max. temperature in a temperature program)
- 0.53 mm ID: T_{max} 300 and 320 °C resp.

Similar phases

- OV-17, DB-17, HP-50+, HP-17, SPB[™]-50, SP-2250, Rxi[®]-17, Rtx[®]-50, CP-Sil 24 CB, 007-17, ZB-50

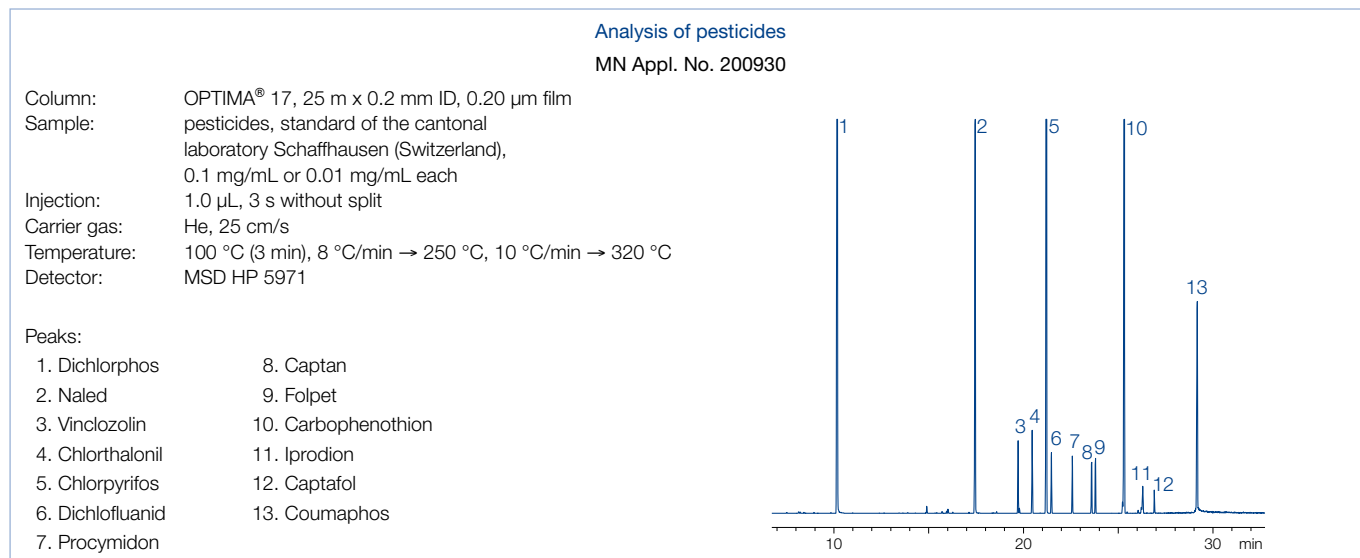

OPTIMA[®] 17

	Length → 10 m	12 m	15 m	25 m	30 m	50 m	60 m
0.1 mm ID (0.4 mm OD)							
0.10 µm film	726848.10						
0.2 mm ID (0.4 mm OD)							
0.20 µm film		726065.12		726065.25		726065.50	
0.50 µm film				726066.25		726066.50	
0.25 mm ID (0.4 mm OD)							
0.15 µm film				726742.25	726742.30	726742.50	726742.60
0.25 µm film			726022.15	726022.25	726022.30	726022.50	726022.60
0.50 µm film				726067.25	726067.30	726067.50	726067.60
0.32 mm ID (0.5 mm OD)							
0.15 µm film					726755.30		
0.25 µm film				726351.25	726351.30	726351.50	726351.60
0.35 µm film				726757.25	726757.30	726757.50	726757.60
0.50 µm film				726744.25	726744.30	726744.50	726744.60
0.53 mm ID (0.8 mm OD)							
1.00 µm film	726747.10		726747.15	726747.25	726747.30		

In addition to this standard program we will be happy to supply columns custom-made to your specifications. Information about scope of delivery, special cages and integrated guard columns see additional information for GC columns on page 311.



OPTIMA® · medium polar capillary columns

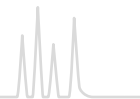

OPTIMA® 17 MS silarylene phase · USP G3

★ Key features

- Medium polar silarylene phase with selectivity analogue to 50 % phenyl – 50 % methylpolysiloxane, no CN groups in the polymer
- Structure see page 317

✓ Recommended application

- Ideal for ion trap detectors
- Optimum reference column in combination with a 1 MS or 5 MS
- All-round phase for environmental analysis, ultra-trace analysis, EPA methods, pesticide, PCBs, food and drug analysis

✍ Temperature

- T_{max} 340 °C (long-term temperature),
- T_{max} 360 °C (short-term max. temperature in a temperature program)

Similar phases

- OV-17, AT™-50, BPX™-50, DB-17, DB-17ms, HP-50+, HP-17, SPB™-50, SPB™-17, SP-2250, Rtx®-50, CP-Sil 24 CB, 007-17, VF-17ms, ZB-50

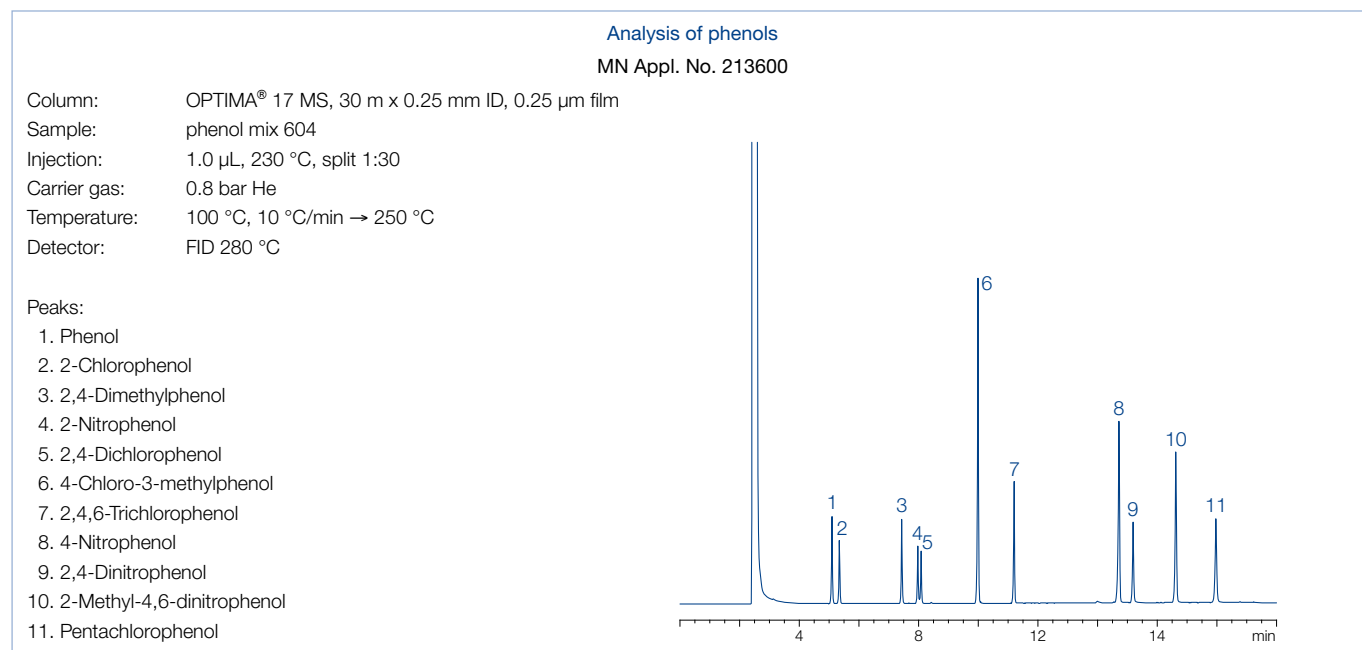

OPTIMA® 17 MS

	Length → 30 m	60 m
0.25 mm ID (0.4 mm OD)		
0.25 µm film	726162.30	726162.60
0.32 mm ID (0.5 mm OD)		
0.25 µm film	726165.30	726165.60

In addition to this standard program we will be happy to supply columns custom-made to your specifications. Information about scope of delivery, special cages and integrated guard columns see additional information for GC columns on page 311.

Further applications can be found online in our application database at ChromaAppDB.mn-net.com



OPTIMA[®] · medium polar capillary columns



OPTIMA[®] 210 trifluoropropyl-methylpolysiloxane (50 % trifluoropropyl) · close equivalent to USP G6

★ Key features

- Midpolar phase
- Structure see page 317

✓ Recommended application

- Environmental analysis, especially for *o*-, *m*- and *p*-substituted aromatic hydrocarbons

✍ Temperature

- T_{max} 260 °C (long-term temperature), T_{max} 280 °C (short-term max. temperature in a temperature program)

Similar phases

- OV-210, DB-210, Rtx[®]-200, 007-210

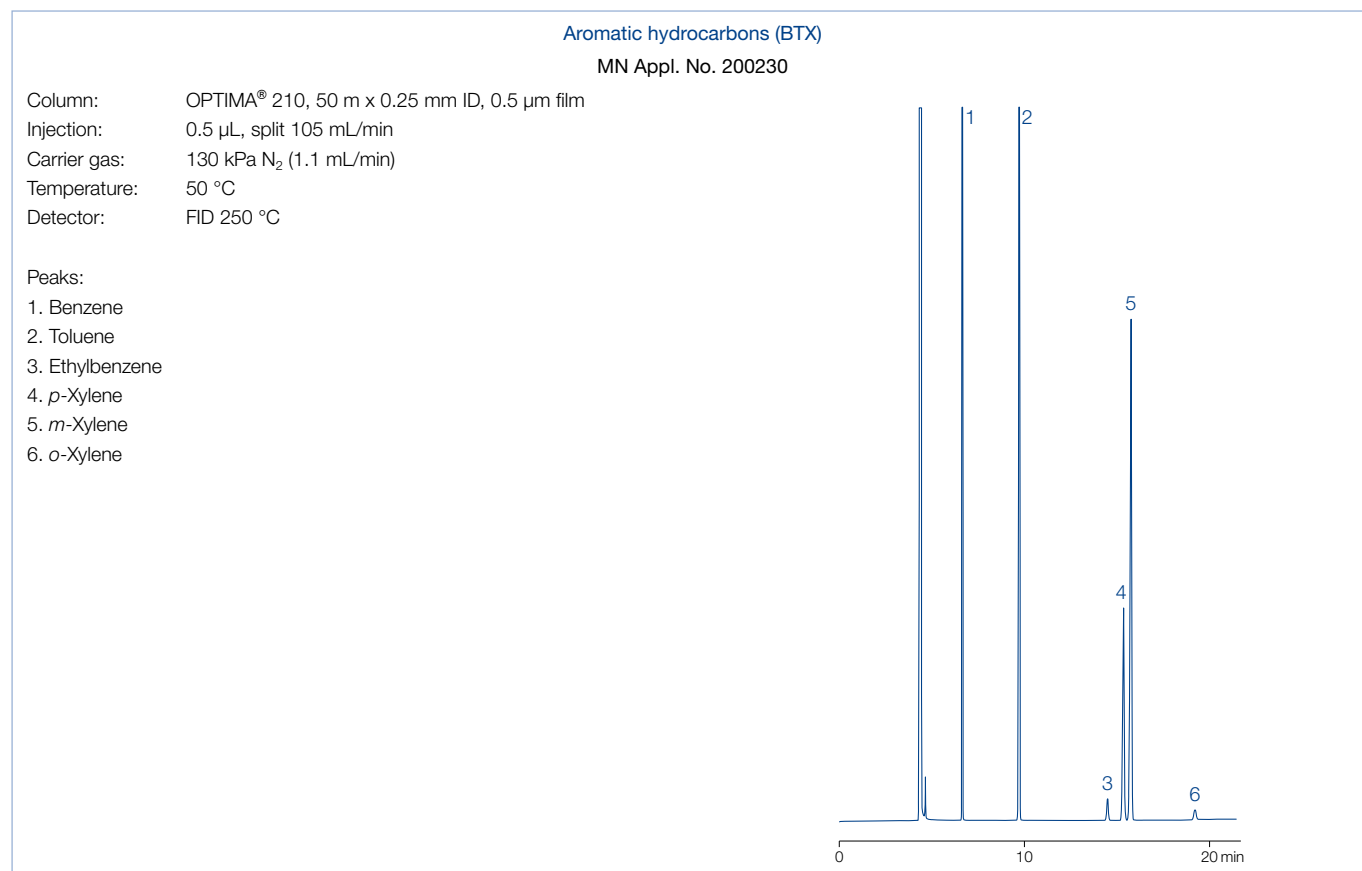

OPTIMA[®] 210

	Length →				
	15 m	25 m	30 m	50 m	60 m
0.25 mm ID (0.4 mm OD)					
0.25 µm film	726871.15	726871.25	726871.30	726871.50	726871.60
0.50 µm film			726874.30	726874.50	726874.60
0.32 mm ID (0.5 mm OD)					
0.25 µm film	726877.15		726877.30	726877.50	726877.60
0.50 µm film		726880.25	726880.30	726880.50	726880.60

In addition to this standard program we will be happy to supply columns custom-made to your specifications. Information about scope of delivery, special cages and integrated guard columns see additional information for GC columns on page 311.



OPTIMA® · medium polar capillary columns

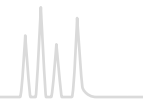

OPTIMA® 225 50 % cyanopropyl-methyl – 50 % phenylmethylpolysiloxane · close equivalent to USP G7 / G19

★ Key features

- Midpolar phase
- Structure see page 317

✓ Recommended application

- Fatty acid analysis

✍ Temperature

- T_{max} 260 °C (long-term temperature),
T_{max} 280 °C (short-term max. temperature in a temperature program)

Similar phases

- OV-210, DB-210, Rtx®-200, 007-210

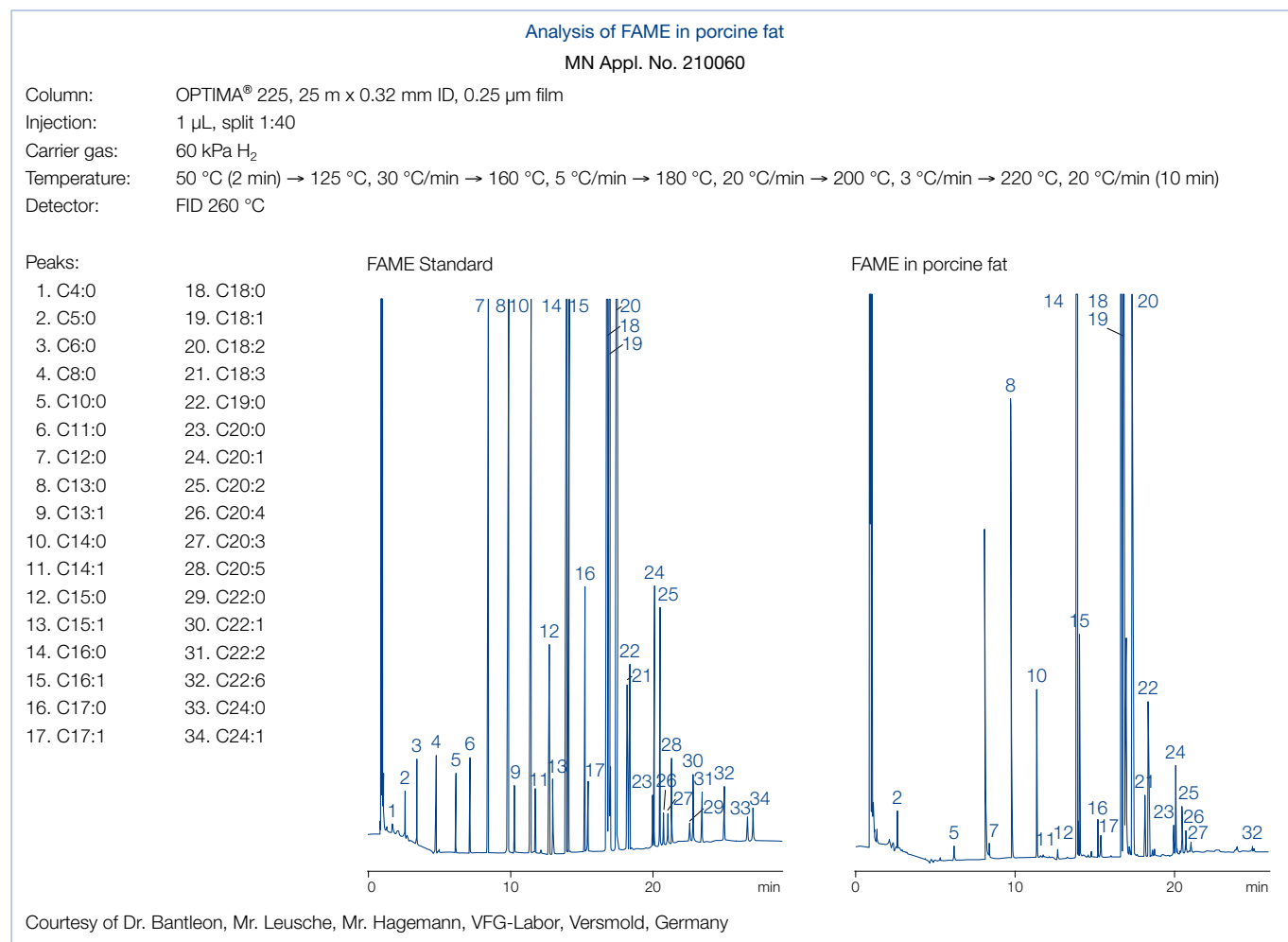

OPTIMA® 225

Length →	15 m	25 m	30 m	50 m	60 m
0.1 mm ID (0.4 mm OD)					
0.10 µm film					
0.25 mm ID (0.4 mm OD)					
0.25 µm film	726118.15	726118.25	726118.30	726118.50	726118.60
0.32 mm ID (0.5 mm OD)					
0.25 µm film		726352.25	726352.30	726352.50	726352.60

In addition to this standard program we will be happy to supply columns custom-made to your specifications. Information about scope of delivery, special cages and integrated guard columns see additional information for GC columns on page 311.



OPTIMA® 240 33 % cyanopropyl-methyl – 67 % dimethylpolysiloxane

★ Key features

- Midpolar phase
- Structure see page 317

✓ Recommended application

- FAMES, dioxins

✍ Temperature

- T_{max} 260 °C (long-term temperature),
T_{max} 280 °C (short-term max. temperature in a temperature program)

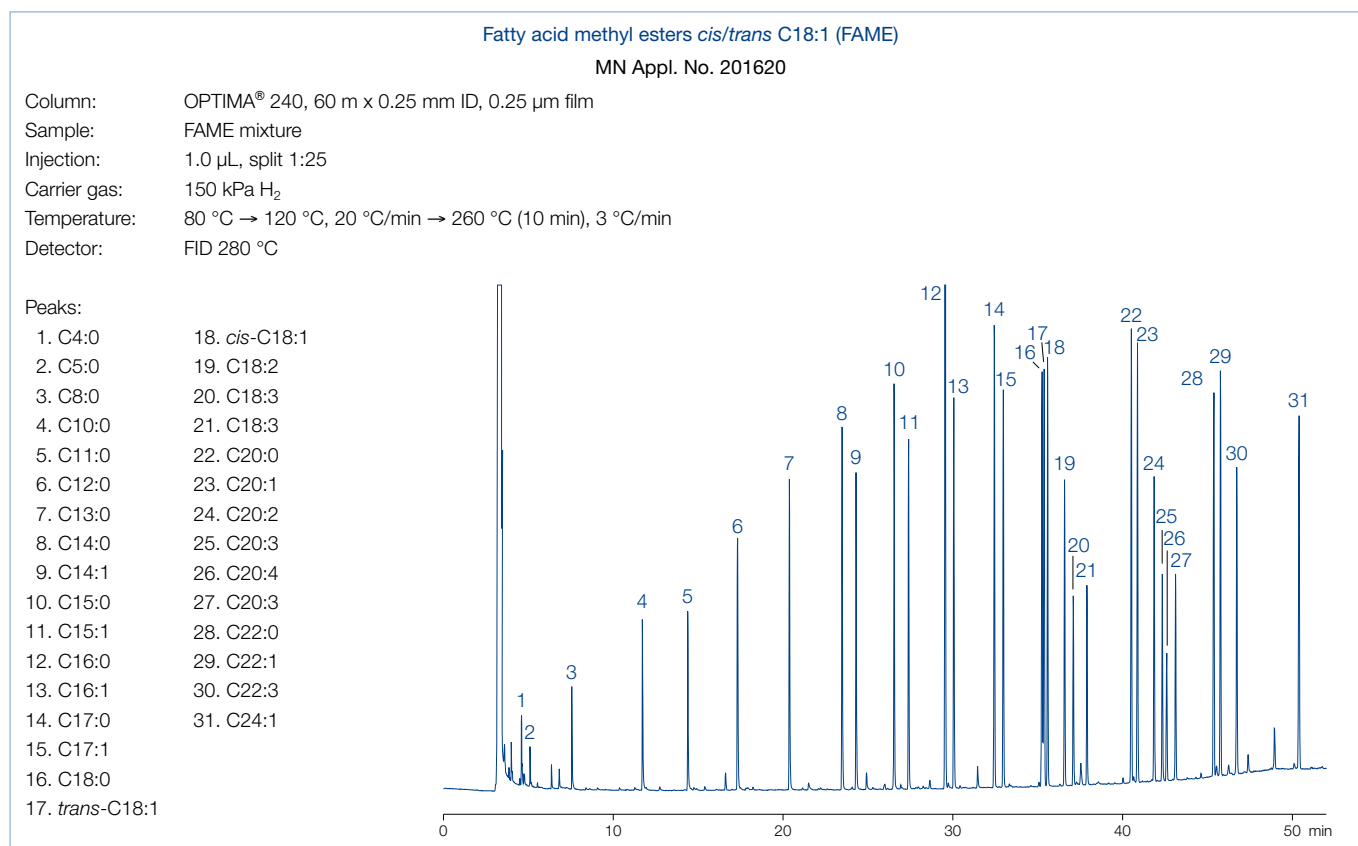

OPTIMA® 240

	Length → 25 m	30 m	50 m	60 m
0.25 mm ID (0.4 mm OD)				
0.25 µm film		726089.30	726089.50	726089.60
0.50 µm film		726090.30		726090.60
0.32 mm ID (0.5 mm OD)				
0.25 µm film	726091.25	726091.30	726091.50	726091.60
0.35 µm film		726095.30		726095.60
0.50 µm film		726096.30		726096.60

In addition to this standard program we will be happy to supply columns custom-made to your specifications. Information about scope of delivery, special cages and integrated guard columns see additional information for GC columns on page 311.

Further applications can be found online in our application database at ChromaAppDB.mn-net.com

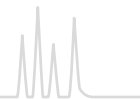

OPTIMA® WAX polyethylene glycol 20 000 Da · USP G16

★ Key features

- Polar phase
- Structure see page 317

✓ Recommended application

- Solvent analysis and alcohols, suitable for aqueous solutions

✍ Temperature

- T_{max} 240 °C (long-term temperature), T_{max} 250 °C (short-term max. temperature in a temperature program)
- 0.53 mm ID: T_{max} 220 and 240 °C resp.

Similar phases

- PERMABOND® CW 20 M (see page 342), DB-Wax, Supelcowax, HP-Wax, HP-INNOWAX, Rtx-Wax, CP-Wax 52 CB, Stabilwax, 007-CW, BP20, AT-Wax, ZB-Wax

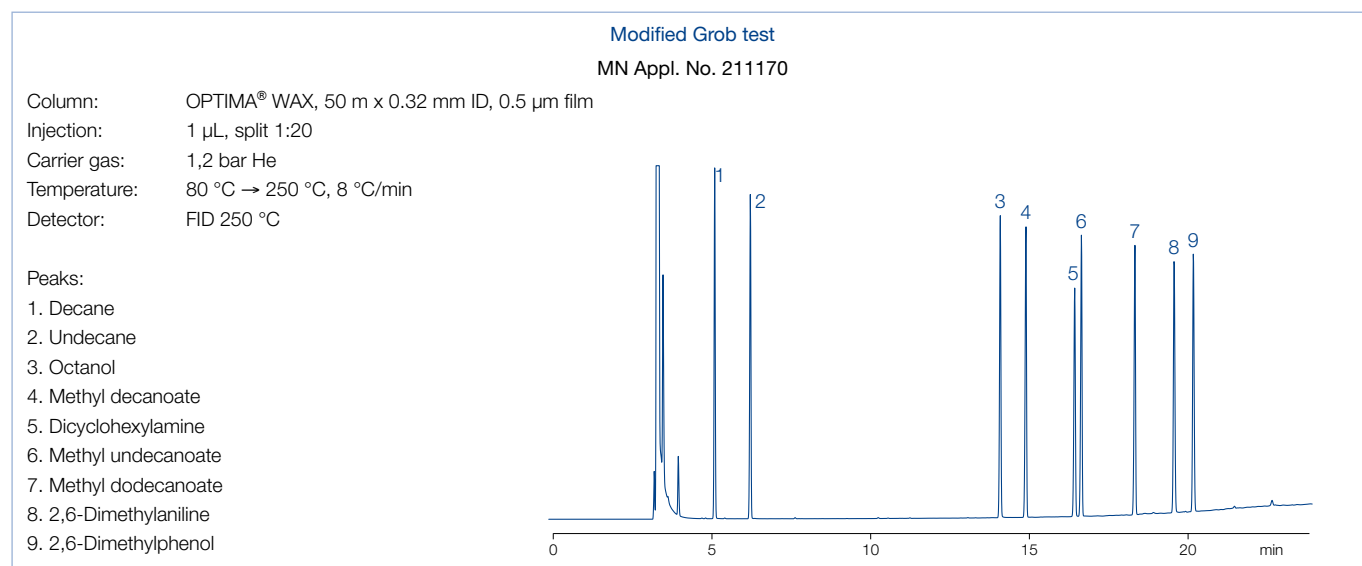

OPTIMA® WAX

	Length → 25 m	30 m	50 m	60 m
0.25 mm ID (0.4 mm OD)				
0.25 µm film	726600.25	726600.30	726600.50	726600.60
0.32 mm ID (0.5 mm OD)				
0.25 µm film	726321.25	726321.30	726321.50	726321.60
0.50 µm film	726296.25	726296.30	726296.50	726296.60
0.53 mm ID (0.8 mm OD)				
1.00 µm film	726549.25	726549.30		
2.00 µm film		726548.30		

In addition to this standard program we will be happy to supply columns custom-made to your specifications. Information about scope of delivery, special cages and integrated guard columns see additional information for GC columns on page 311.

Further applications can be found online in our application database at ChromaAppDB.mn-net.com



OPTIMA® FFAP polyethylene glycol 2-nitroterephthalate · USP G35 / close equivalent to USP G25

★ Key features

- Polar phase (FFAP = Free Fatty Acid Phase)
- Structure see page 317

✓ Recommended application

- Fatty acid methyl esters (FAMEs), free carboxylic acids

✍ Temperature

- 0.10–0.32 mm ID:
 - T_{max} 250 °C (long-term temperature),
 - T_{max} 260 °C (short-term max. temperature in a temperature program)
- 0.53 mm ID: T_{max} 220 and 240 °C, resp.

Similar phases

- PERMABOND® FFAP (see page 343), DB-FFAP, HP-FFAP, CP-Wax 58 FFAP CB, 007-FFAP, CP-FFAP CB, Nukol™, AT-1000, SPB-1000, BP21, OV-351

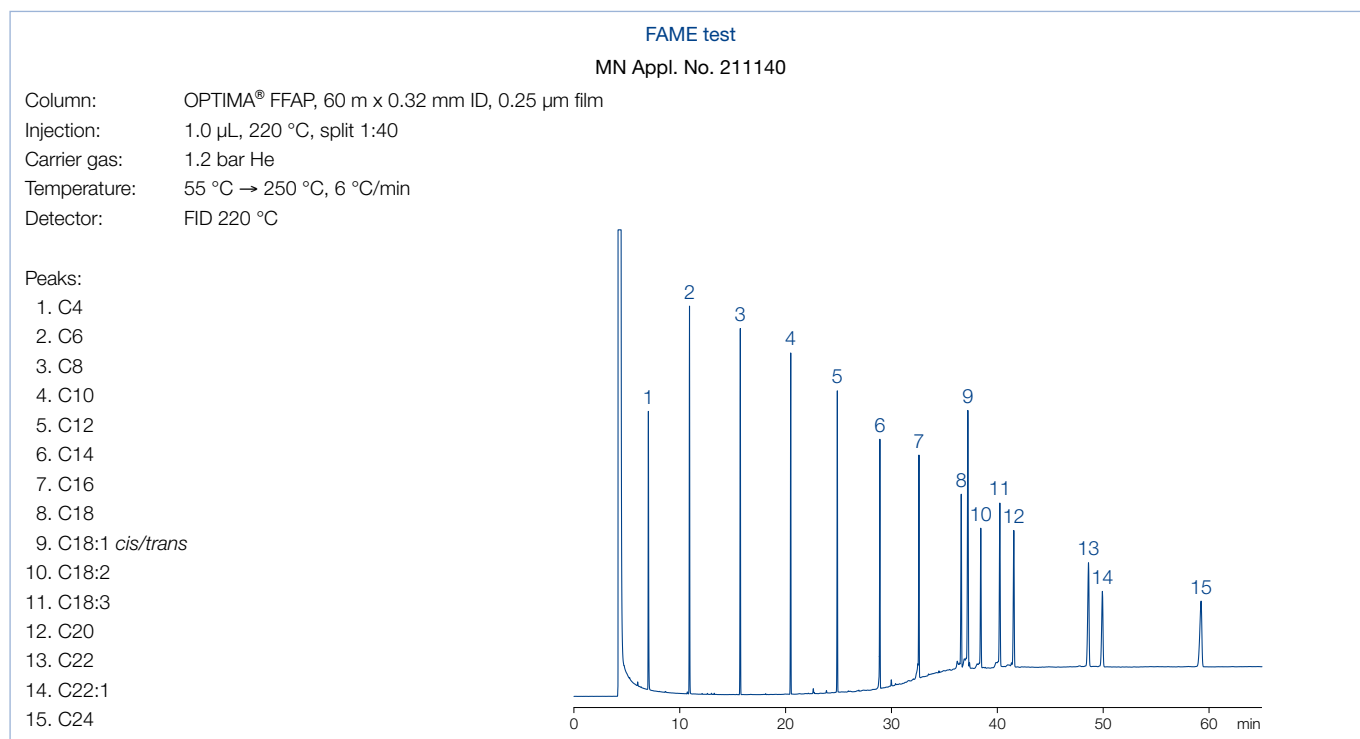

OPTIMA® FFAP

	Length →			
	10 m	25 m	30 m	50 m
0.1 mm ID (0.4 mm OD)				
0.10 µm film	726180.10			
0.25 mm ID (0.4 mm OD)				
0.25 µm film	726116.25	726116.30	726116.50	726116.60
0.32 mm ID (0.5 mm OD)				
0.25 µm film	726341.25	726341.30	726341.50	726341.60
0.50 µm film	726344.25	726344.30	726344.50	
0.53 mm ID (0.8 mm OD)				
0.50 µm film		726345.30		
1.00 µm film	726346.25			

In addition to this standard program we will be happy to supply columns custom-made to your specifications. Information about scope of delivery, special cages and integrated guard columns see additional information for GC columns on page 311.



PERMABOND® capillary columns

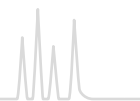

PERMABOND® CW 20 M polyethylene glycol 20 000 Dalton · USP G16

★ Key features

- Polar phase

✓ Recommended application

- Solvent analysis and alcohols, suitable for aqueous solutions

✍ Temperature

- 0.1–0.32 mm ID:
 - T_{max} 220 °C (long-term temperature),
 - T_{max} 240 °C (short-term max. temperature in a temperature program)
- 0.53 mm ID: T_{max} 200 and 220 °C, resp.

Similar phases

- See OPTIMA® WAX (see page 340)

PERMABOND® CW 20 M

	Length → 10 m	25 m	30 m	50 m	60 m
0.1 mm ID (0.4 mm OD)					
0.10 µm film	723064.10				
0.25 mm ID (0.4 mm OD)					
0.25 µm film	723060.10	723060.25	723060.30	723060.50	723060.60
0.32 mm ID (0.5 mm OD)					
0.25 µm film	723321.10	723321.25	723321.30	723321.50	723321.60
0.35 µm film	723827.10	723827.25		723827.50	
0.50 µm film	723296.10	723296.25	723296.30	723296.50	723296.60
0.53 mm ID (0.8 mm OD)					
0.50 µm film	723515.10	723515.25			
1.00 µm film	723549.10	723549.25	723549.30		
2.00 µm film	723517.10	723517.25	723517.30		

In addition to this standard program we will be happy to supply columns custom-made to your specifications. Information about scope of delivery, special cages and integrated guard columns see additional information for GC columns on page 311.

Further applications can be found online in our application database at ChromaAppDB.mn-net.com

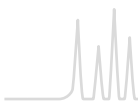

PERMABOND[®] capillary columns



PERMABOND[®] FFAP polyethylene glycol 2-nitroterephthalate · USP G35 / close equivalent to G25

★ Key features

- Polar phase

✓ Recommended application

- FAMES, free carboxylic acids

✍ Temperature

- 0.1–0.32 mm ID:
 - T_{max} 220 °C (long-term temperature),
 - T_{max} 240 °C (short-term max. temperature in a temperature program)
- 0.53 mm ID: T_{max} 200 and 220 °C, resp.

Similar phases

- See OPTIMA[®] FFAP (see page 341)

PERMABOND[®] FFAP

	Length → 10 m	20 m	25 m	30 m	50 m	60 m
0.1 mm ID (0.4 mm OD)						
0.10 µm film	723180.10	723180.20				
0.25 µm film	723181.10					
0.25 mm ID (0.4 mm OD)						
0.10 µm film			723936.25		723936.50	
0.25 µm film	723116.10		723116.25	723116.30	723116.50	723116.60
0.32 mm ID (0.5 mm OD)						
0.10 µm film			723356.25		723356.50	
0.25 µm film			723341.25	723341.30	723341.50	723341.60
0.35 µm film	723830.10		723830.25		723830.50	
0.50 µm film	723344.10		723344.25	723344.30	723344.50	723344.60
0.53 mm ID (0.8 mm OD)						
1.00 µm film	723555.10		723555.25		723555.50	

In addition to this standard program we will be happy to supply columns custom-made to your specifications. Information about scope of delivery, special cages and integrated guard columns see additional information for GC columns on page 311.

Further applications can be found online in our application database at ChromaAppDB.mn-net.com

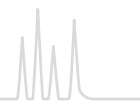

Capillary columns for special GC separations

Certain analytical separations can be accomplished more easily with chromatographic columns, that have been especially developed for that task, compared with standard columns. The

following table summarizes our program of GC speciality capillaries, the individual columns will be described in detail on the following pages.

Overview

Separation/special application	Recommended capillary column	Page
Fast GC column with 0.10 mm ID	OPTIMA® 1, OPTIMA® 5, OPTIMA® δ-3, OPTIMA® δ-6 OPTIMA® 17, OPTIMA® 225, OPTIMA® FFAP PERMABOND® CW 20 M, PERMABOND® FFAP	345
Enantiomer separation cyclodextrin phases	FS-LIPODEX® A, FS-LIPODEX® B, FS-LIPODEX® C FS-LIPODEX® D, FS-LIPODEX® E, FS-LIPODEX® G	347
	FS-HYDRODEX β-PM, FS-HYDRODEX β-3 P, FS-HYDRODEX β-6TBDM, FS-HYDRODEX β-6TBDE, FS-HYDRODEX β-6TBDE, FS-HYDRODEX β-TBDAc, FS-HYDRODEX γ-DIMOM	349
Biodiesel		
Methanol analysis	OPTIMA® BioDiesel M	351
FAME analysis	OPTIMA® BioDiesel F	351
Glycerol and triglycerides	OPTIMA® BioDiesel G	351
Triglycerides	OPTIMA® 1-TG OPTIMA® 17-TG	353 353
High temperature GC	OPTIMA® 5 HT	354
Amines		
Polyfunctional amines	OPTIMA® 5 Amine	355
Amine separations	FS-CW 20 M-AM	356
Petrochemical products (complex hydrocarbon mixtures)	PERMABOND® P-100	357
Environmental analysis of volatile halogenated hydrocarbons	PERMABOND® SE-54 HKW	357
Silanes (monomeric, e.g., chlorosilanes)	PERMABOND® Silane	359
Diethylene glycol, e.g., for the quality control of wine	PERMABOND® CW 20 M-DEG	359



Fast GC

★ Key features

- Decreased column diameters, high heating rates and decreased column lengths for faster GC separations with high resolution efficiency
- Small inner diameters combined with very fast temperature programs can reduce the analysis time by up to 80 %
- High sensitivity detectors with small volume and very short response time, as well as very rapid data acquisition and processing

✍ Temperature

- High heating rates place special demands on stationary phases. OPTIMA® columns meet exactly this requirement: very low bleeding, long lifetimes – even for continuous high heating rates

Comparison of a separation on a 50 m standard capillary with separation on a 10 m fast GC column

MN Appl. No. 211260

Peaks:

1. Octanol
2. Undecane
3. Dimethylaniline
4. Dodecane
5. Decylamine
6. Methyl decanoate
7. Methyl undecanoate
8. Henicosane
9. Docosane
10. Tricosane

A) Fast GC column

Column: OPTIMA® 5, 10 m x 0.1 mm ID,
0.1 µm film

injection 1 µL, split 1:40,
carrier gas 0.75 bar He

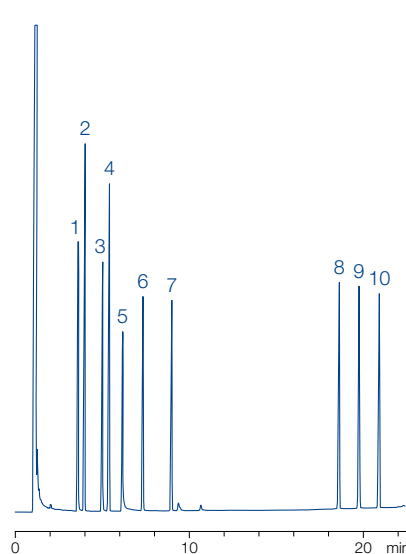

B) standard GC column

Column: OPTIMA® 5, 50 m x 0.25 mm ID,
0.25 µm film

injection 1 µL, split 1:35,
carrier gas 1.5 bar He

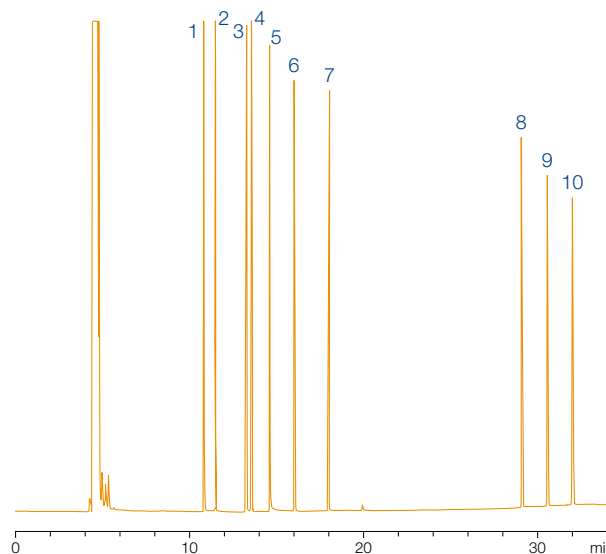

Both separations:

Temperature: 80 °C → 320 °C (10 min), 8 °C/min

Detector: FID

While maintaining the temperature program and halving the pressure a time saving of 30 % results with identical separation efficiency.



Capillary columns for Fast GC

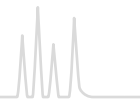

Columns for Fast GC

Phase	Maximum temperature	ID [mm]	Film thickness [μm]	REF (10 m)	REF (20 m)
OPTIMA® 1	340/360 °C	0.10	0.10	726024.10	726024.20
		0.10	0.40		726025.20
OPTIMA® 5	340/360 °C	0.10	0.10	726846.10	
OPTIMA® δ-3	340/360 °C	0.10	0.10	726410.10	726410.20
OPTIMA® δ-6	340/360 °C	0.10	0.10	726490.10	
OPTIMA® 17	320/340 °C	0.10	0.10	726848.10	
OPTIMA® 225	260/280 °C	0.10	0.10	726080.10	
OPTIMA® FFAP	250/260 °C	0.10	0.10	726180.10	
PERMABOND® CW 20 M	220/240 °C	0.10	0.10	723064.10	
PERMABOND® FFAP	220/240 °C	0.10	0.10	723180.10	723180.20
		0.10	0.25	723181.10	
OPTIMA® 5 Amine	300/320 °C	0.10	0.40	726361.10	
FS-CW 20 M-AM	220/240 °C	0.10	0.25	733111.10	
FS-LIPODEX® E	200/220 °C	0.10	0.10	723382.10	
FS-HYDRODEX β-6TBDM	230/250 °C	0.10	0.10	723383.10	

In addition to this standard program, all MN GC phases can be custom-made as fast GC columns

Further applications can be found online in our application database at ChromaAppDB.mn-net.com



Capillary columns for enantiomer separation



LIPODEX® cyclodextrin phases for enantiomer separation

★ Key features

- Base material: cyclic oligosaccharides consisting of six (α -cyclodextrin), seven (β -cyclodextrin) or eight (γ -cyclodextrin) glucose units bonded through 1,4-linkages
- Regioselective alkylation and/or acylation of the hydroxyl groups leads to lipophilic phases with varying enantioselectivity, which are well suited for GC enantiomer analysis
- Important advantage: many compounds can be analyzed without derivatization (however, for certain substances enantioselectivity can be favorably influenced by formation of derivatives)

Note

- Water as solvent is strictly forbidden for all cyclodextrin phases
- Dry the sample with our CHROMAFIX® Dry (Na_2SO_4) cartridges (see page 62)
- Use suitable nonpolar solvent

✓ Recommended application

- A large number of separations have been achieved, however, it is not possible to make a general prediction, which phase could solve a given separation task. Even for compounds with small structural differences or within homologous series the enantiodifferentiation can be quite different. The following table shows typical applications.

Phase	Cyclodextrin derivate	T _{max} [°C]	Recommended application
LIPODEX® A	hexakis-(2,3,6-tri-O-pentyl)- α -CD	200 / 220	carbohydrates, polyols, diols, hydroxycarboxylic acid esters, (epoxy-) alcohols, glycerol derivatives, spiroacetals, ketones, alkyl halides
LIPODEX® B	hexakis-(2,6-di-O-pentyl-3-O-acetyl)- α -CD	200 / 220	lactones, diols (cyclic carbonates), aminols, aldols (O-TFA), glycerol derivatives (cyclic carbonates)
LIPODEX® C	heptakis-(2,3,6-tri-O-pentyl)- β -CD	200 / 220	Alcohols, cyanhydrins, olefins, hydroxycarboxylic acid esters, alkyl halides
LIPODEX® D	heptakis-(2,6-di-O-pentyl-3-O-acetyl)- β -CD	200 / 220	aminols (TFA), β -amino acid esters, trans-cycloalkane-1,2-diols, trans-cycloalkane-1,2-diols, trans-cycloalkane-1,3-diols (TFA)
LIPODEX® E	octakis-(2,6-di-O-pentyl-3-O-butyryl)- γ -CD	200 / 220	α -amino acids, α - and β -hydroxycarboxylic acid esters, alcohols (TFA), diols (TFA), ketones, pheromones (cyclic acetals), amines, alkyl halides, lactones
LIPODEX® G	octakis-(2,3-di-O-pentyl-6-O-methyl)- γ -CD	220 / 240	menthol isomers, ketones, alcohols, carboxylic acid esters, terpenes

LIPODEX®

	Length →	10 m	25 m	50 m
		0.10 mm ID	0.25 mm ID	0.25 mm ID
FS-LIPODEX® A			723360.25	723360.50
FS-LIPODEX® B			723362.25	723362.50
FS-LIPODEX® C			723364.25	723364.50
FS-LIPODEX® D			723366.25	723366.50
FS-LIPODEX® E		723382.10	723368.25	723368.50
FS-LIPODEX® G			723379.25	723379.50

All columns with 0.4 mm OD



Capillary columns for enantiomer separation

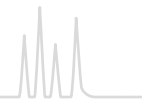

Enantiomer separation of amino acid methyl esters (TFA)

MN Appl. No. 202592

Column: FS-LIPODEX® E, 25 m x 0.25 mm ID
Injection: 1 µL, split ~ 1: 100
Carrier gas: 60 kPa H₂
Temperature: 90 → 190 °C, 4 °C/min
Detector: FID 250 °C

Peaks:

(D is eluted before L except for proline: L before D)

1. Alanine
2. Valine
3. Leucine
4. Proline
5. Aspartic acid
6. Phenylalanine

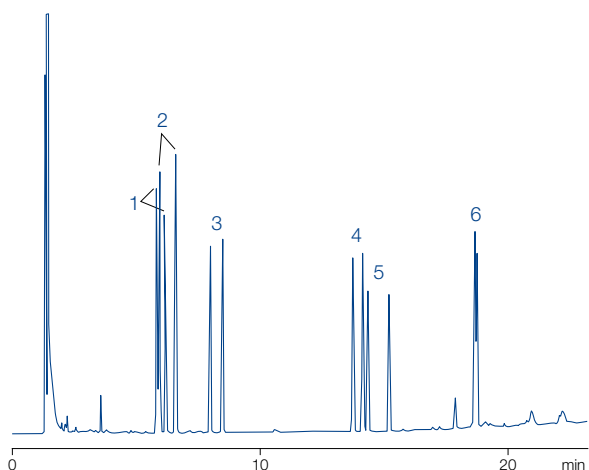

Separation of chiral constituents of peppermint oil

MN Appl. No. 250410

W. A. König et al., High Resol. Chromatogr. 20 (1997) 55–61
Column: FS-LIPODEX® G, 25 m x 0.25 mm ID
Carrier gas: 50 kPa H₂
Temperature: 75 °C, isothermal
Detector: FID

Peaks:

- | | |
|-------------------------------|-----------------------|
| 1. (+)-trans-Sabinene hydrate | 10. (+)-Neomenthol |
| 2. (+)-Menthone | 11. (-)-Neomenthol |
| 3. (+)-Isomenthone | 12. (+)-Neoisomenthol |
| 4. (-)-Menthone | 13. (+)-Menthol |
| 5. (-)-Isomenthone | 14. (-)-Neoisomenthol |
| 6. (+)-Menthofuran | 15. (+)-Piperitone |
| 7. (-)-Isopulegol | 16. (-)-Menthol |
| 8. (-)-Menthyl acetate | 17. (+)-Isomenthol |
| 9. (+)-Pulegone | 18. (-)-Isomenthol |

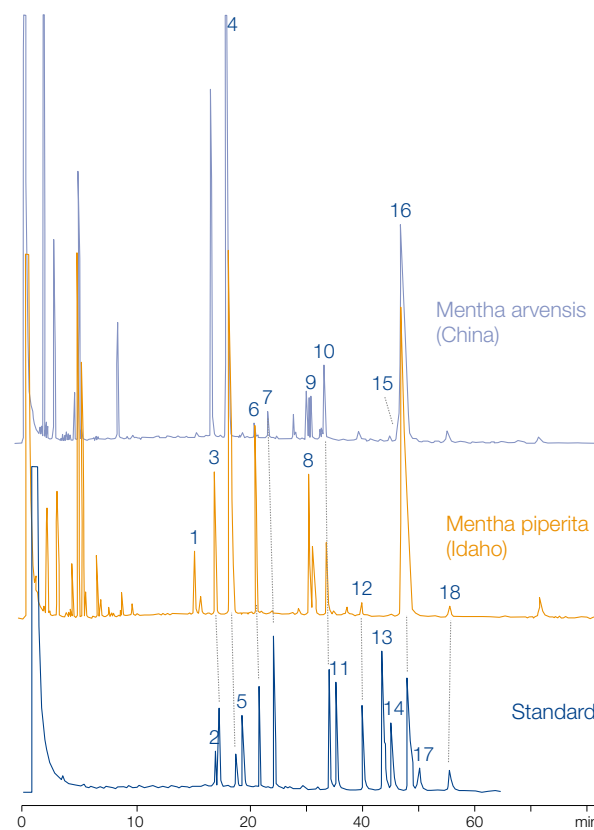

Cyclodextrin derivatives

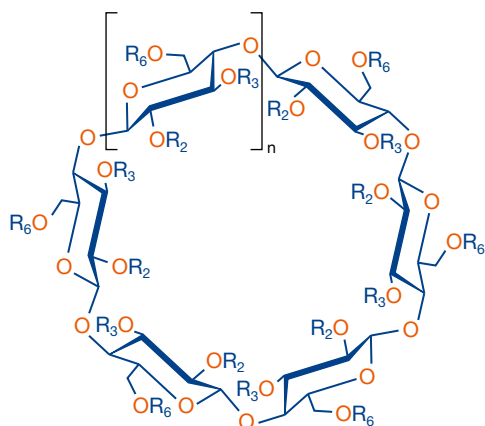

Further applications can be found online in our application database at ChromaAppDB.mn-net.com



HYDRODEX cyclodextrin phases for enantiomer separation

✓ Recommended application

- Cyclodextrin derivatives (see page 348) with high melting point: for GC enantiomer separation diluted with polysiloxanes

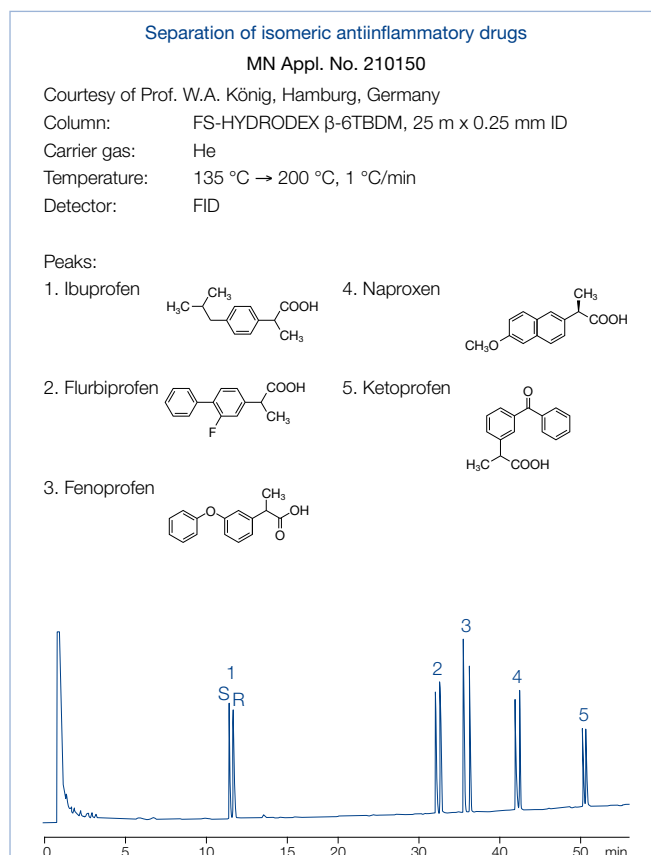
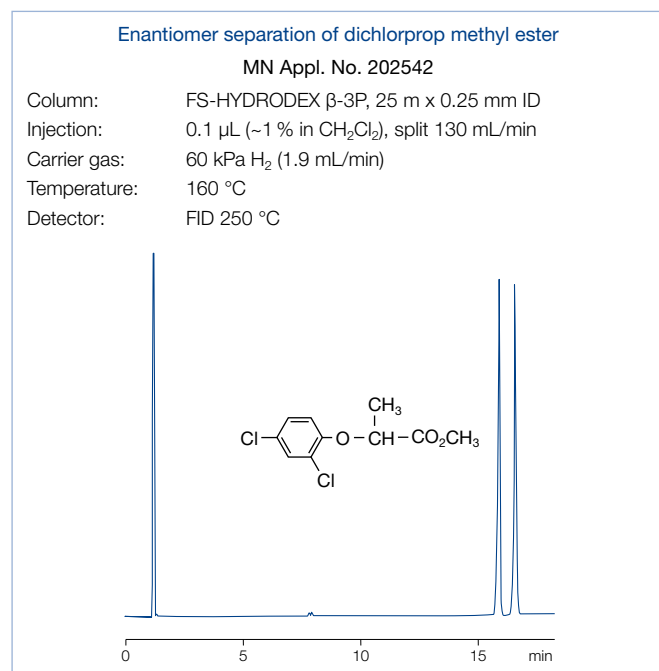

Phase	Cyclodextrin derivative (diluted with optimized polysiloxane)	T _{max} [°C]	Recommended application
HYDRODEX β-PM	heptakis-(2,3,6-tri-O-methyl)-β-CD	230 / 250	hydroxycarboxylic acid esters, alcohols, diols, olefins, lactones, acetals
HYDRODEX β-3P	heptakis-(2,6-di-O-methyl-3-O-pentyl)-β-CD	230 / 250	terpenes, dienes, allenes, terpene alcohols, 1,2-epoxyalkanes, carboxylic acids (esters), hydroxycarboxylic acid esters, pharmaceuticals, pesticides
HYDRODEX β-6TBDM	heptakis-(2,3-di-O-methyl-6-O-t-butyl-dimethyl-silyl)-β-CD	230 / 250	γ-lactones, cyclopentanones, terpenes, esters, tartrates
HYDRODEX β-6TBDE	heptakis-(2,3-di-O-ethyl-6-O-t-butyl-dimethyl-silyl)-β-CD	230 / 250	essential oils
HYDRODEX β-TBDAC	heptakis-(2,3-di-O-acetyl-6-O-t-butyl-dimethyl-silyl)-β-CD	220 / 240	alcohols, esters, ketones, aldehydes, δ-lactones
HYDRODEX γ-TBDAC	octakis-(2,3-di-O-acetyl-6-O-t-butyl-dimethyl-silyl)-γ-CD	220 / 240	cyclic ketones, aromatic ketones, oxiranes, aromatic esters, aromatic amides
HYDRODEX γ-DI-MOM	octakis-(2,3-di-O-methoxymethyl-6-O-t-butyl-dimethyl-silyl)-γ-CD	220 / 240	ketones, terpenes, cyclic ethers, alcohols, amines



Capillary columns for enantiomer separation

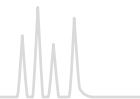

Separation of (R/S) citronellol + citronellal

MN Appl. No. 212440

Column: FS-HYDRODEX β -TBDAC, 50 m x 0.25 mm ID
Injection: 1 μ L, 1:1000 in CH₂Cl₂, split 25 mL/min
Carrier gas: 1.5 bar H₂
Temperature: 100 °C
Detector: FID 220 °C

Peaks:

1. (R)/(S)-Citronellal
2. (S)/(R)-Citronellal
3. (S)-Citronellol
4. (R)-Citronellol

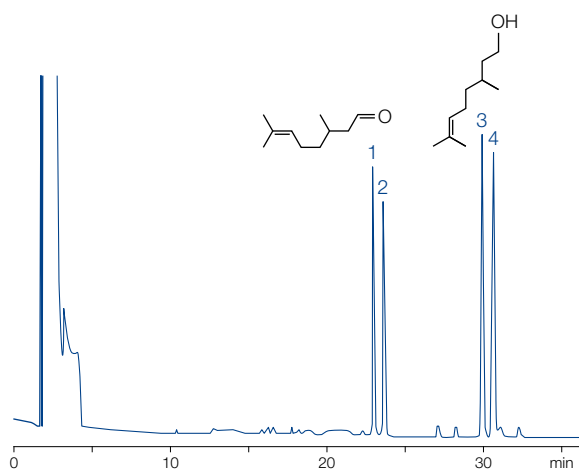

Separation of essential oils

MN Appl. No. 212980/212990/213000

Column: FS-HYDRODEX γ -TBDAC, 50 m x 0.25 mm ID
Injektor: 220 °C
Carrier gas: 1.2 bar H₂
Temperature: 125 °C
Detector: FID 220 °C

Peaks:

1. Fenchone (1.5 mg/mL)
2. Menthone (0.5 mg/mL)
3. Menthol (2 mg/mL)

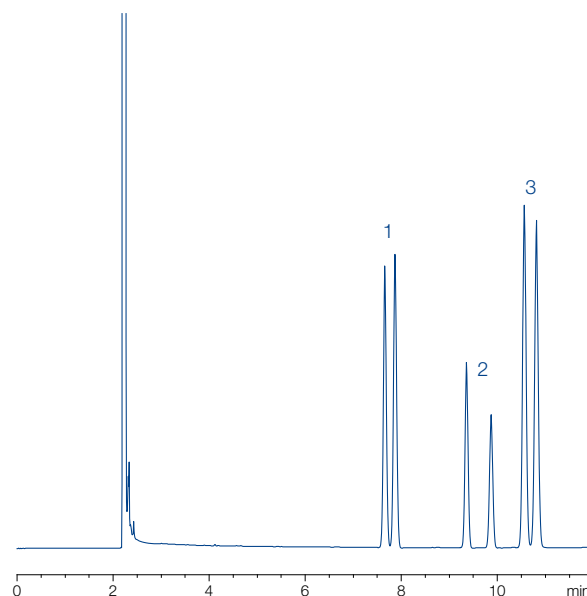

HYDRODEX

Length →	10 m 0.10 mm ID	25 m 0.25 mm ID	50 m 0.25 mm ID
FS-HYDRODEX β -PM		723370.25	723370.50
FS-HYDRODEX β -3P		723358.25	723358.50
FS-HYDRODEX β -6TBDM	723383.10	723381.25	723381.50
FS-HYDRODEX β -6TBDE		723386.25	
FS-HYDRODEX β -TBDAC		723384.25	723384.50
FS-HYDRODEX γ -TBDAC		723387.25	723387.50
FS-HYDRODEX γ -DiMOM		723388.25	723388.50
All columns with 0.4 mm OD			

Further applications can be found online in our application database at ChromaAppDB.mn-net.com

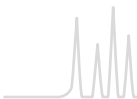

Capillary columns for biodiesel analysis



OPTIMA® BioDiesel for the analysis of biodiesel (DIN EN 14214 / ASTM D 6751)

OPTIMA® BioDiesel M for analysis of methanol in accordance with DIN EN 14110

★ Key features

- The methanol content in biodiesel as specified in DIN EN 14110 must not exceed 0.2 %. The column OPTIMA® BioDiesel M allows the GC headspace analysis of the methanol content in biodiesel in the concentration range from 0.01 to 0.5 % with 2-propanol as internal standard.

Similar phases

- Select™ Biodiesel for Methanol, Trace TR-BioDiesel (M)

✎ Temperature

- T_{\max} 340 °C (long-term temperature),
 T_{\max} 360 °C (short-term max. temperature in a temperature program)

OPTIMA® BioDiesel F for analysis of FAMES in accordance with DIN EN 14103:2011

★ Key features

- The analysis of biodiesel requires separation of typical FAMES between myristic acid (C_{14}) and nervonic acid ($C_{24:1}$) methyl esters. This analysis is possible on OPTIMA® BioDiesel F in only 22 min. Additionally, linolenic acid methyl ester can be determined due to the good resolution. The extended standard DIN EN 14103:2011 also covers smaller FAMES starting from C_6 (see application 214510 on opposite page). Change of the internal standard from C_{17} to C_{19} also allows the analysis of animal fats.

Similar phases

- Select™ Biodiesel for FAME, Trace TR-BioDiesel (F)

✎ Temperature

- T_{\max} 240 °C (long-term temperature),
 T_{\max} 250 °C (short-term max. temperature in a temperature program)

OPTIMA® BioDiesel G for analysis of glycerol and glycerides in accordance with DIN EN 14105

★ Key features

- The capillary column OPTIMA® BioDiesel G allows determination of free glycerol and residues of mono-, di- and triglycerides in FAMES intended as additives for mineral oils. The procedure can be applied for FAMES from rapeseed oil, sunflower oil and soy bean oil. Glycerol as well as mono- and diglycerides are derivatized to more volatile substances by addition of MSTFA in the presence of pyridine (see page 368).

Similar phases

- Select™ Biodiesel for Glycerides, Trace TR-BioDiesel (G), MET-Biodiesel

✎ Temperature

- T_{\max} 380 °C (long-term temperature),
 T_{\max} 400 °C (short-term max. temperature in a temperature program)



Capillary columns for triglyceride analysis

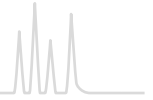

Analysis of FAMES from biodiesel in accordance with DIN EN 14103:2011

MN Appl. No. 214510

Column: OPTIMA® BioDiesel F, 30 m x 0.25 mm ID
 Sample: 50 µg/mL each in dichloromethane
 Injection: 10 µL, 250 °C, split 1:20
 Carrier gas: 1.2 bar He
 Temperature: 80 °C → 250 °C (8.5 min), 20 °C/min
 Detector: FID 260 °C

Peaks:

- | | |
|----------|---------------------|
| 1. C6:0 | 9. C18:1 |
| 2. C8:0 | 10. C18:2 |
| 3. C10:0 | 11. C19:0, int. st. |
| 4. C12:0 | 12. C18:3 |
| 5. C14:0 | 13. C20:0 |
| 6. C16:0 | 14. C22:0 |
| 7. C16:1 | 15. C22:1 |
| 8. C18:0 | 16. C24:0 |

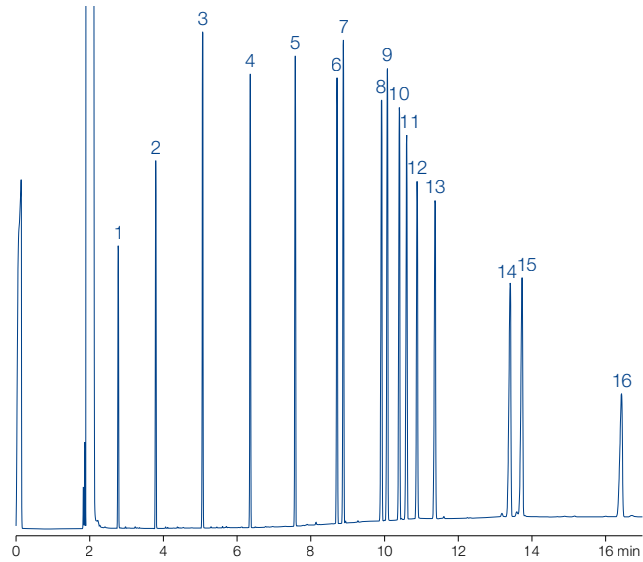

Analysis of glycerol and glycerides from biodiesel

MN Appl. No. 213640

Column: OPTIMA® BioDiesel G,
10 m x 0.25 mm ID
 Sample: A) standard in *n*-heptane
B) biodiesel
 Injection: 2 µL, 350 °C,
CIS (15 °C → 350 °C, 12 °C/s)
 Carrier gas: 0.8 bar H₂, split 1: 2.6
 Temperature: 50 °C (3.5 min) → 180 °C, 15 °C/min
→ 280 °C, 7 °C/min
→ 370 °C (10 min), 10 °C/min
 Detector: FID 380 °C

Peaks:

- Glycerol (TMS)
- Butanetriol (TMS), IS
- Monoolein = glycerol monooleate (TMS)
+ monoacylglycerides
- Tricaprin (glycerol tricaprinate), IS
- Diolein = glycerol dioleate (TMS)
+ diacylglycerides
- Triolein = glycerol trioleate
+ triacylglycerides

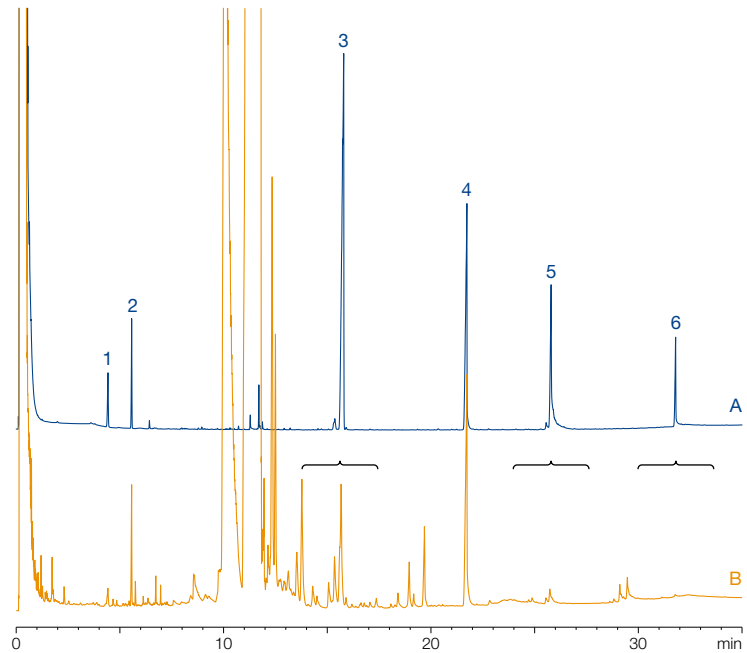

OPTIMA® BioDiesel

	Length → 10 m	30 m
OPTIMA® BioDiesel M		
0.32 mm ID (0.5 mm OD)		726905.30
OPTIMA® BioDiesel F		
0.25 mm ID (0.4 mm OD)		726900.30
OPTIMA® BioDiesel G		
0.25 mm ID (0.4 mm OD)	726903.10	



Capillary columns for triglyceride analysis

OPTIMA® 1-TG · 17-TG for triglyceride analysis · USP G1 / G2 / G38 (1-TG) · USP G3 (17-TG)

★ Key features

- Short capillary columns (max. 25 m and 0.32 mm ID) with low-bleeding stationary phases thermally stable with optimized deactivation

✓ Recommended application

- OPTIMA® 1-TG
100 % dimethylpolysiloxane offers separation according to carbon number
- OPTIMA® 17-TG
phenyl-methyl-polysiloxane (50 % phenyl) for separation according to degree of unsaturation

✍ Temperature

- T_{max} 370 °C (both phases)

Similar phases der OPTIMA® 1-TG:

- SPB-1 TG, DB-1 HT, 400-1 HT, HT-5

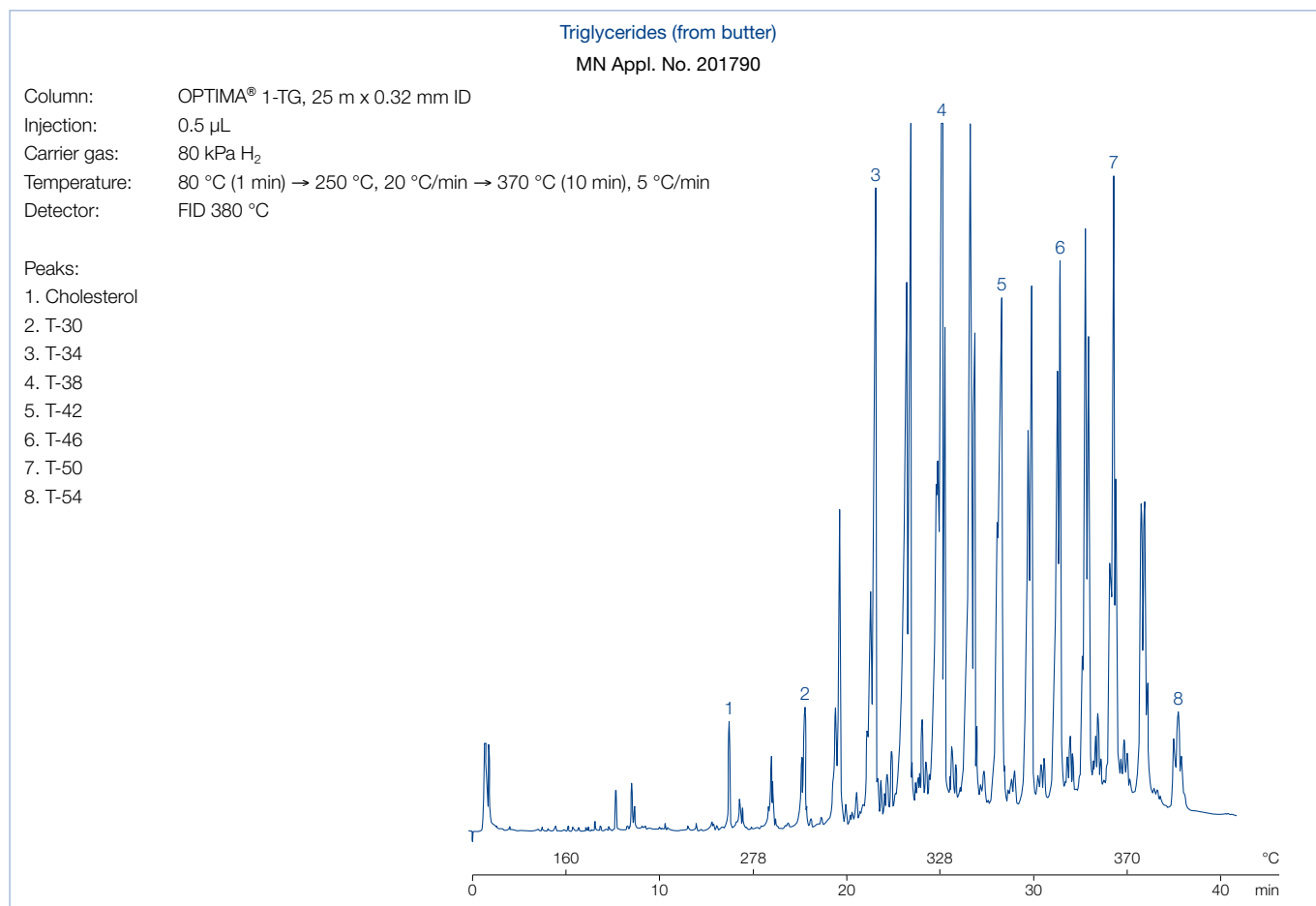

OPTIMA® 1-TG · OPTIMA® 17-TG

	Length → 10 m	25 m
OPTIMA® 1-TG		
0.25 mm ID (0.4 mm OD)	726133.10	726133.25
0.32 mm ID (0.5 mm OD)	726132.10	726132.25
OPTIMA® 17-TG		
0.32 mm ID (0.5 mm OD)	726131.10	726131.25



Capillary columns for high temperature GC

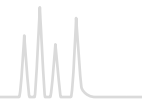

OPTIMA® 5 HT for high temperature GC · USP G27 / G36

★ Key features

- Chemically bonded, cross-linked silarylene phase with polarity similar to a 5 % diphenyl – 95 % dimethylpolysiloxane phase
- Nonpolar phase, low bleeding

Similar phases

- DB-5HT, VF-5HT, HT-5, XTI-5HT, ZB-5HT

✓ Recommended application

- Ideal for MS detectors, can be rinsed with solvents
- For simulated distillation, hydrocarbon, fuel and oil analysis, high-boiling analytes

✍ Temperature

- T_{max} 380 °C (long-term temperature), T_{max} 400 °C (short-term max. temperature in a temperature program)

Separation of motor oil / mineral oil (type A + B), rapid determination in accordance with DIN H-53 / ISO DIS

MN Appl. No. 213400

Column: OPTIMA® 5 HT, 15 m x 0.32 mm ID, 0.25 µm film
 Sample: mineral oil type A + B (hydrocarbon index kit acc. to EN ISO 9377-2) in hexane
 Injection: 1 µL, splitless, 300 °C
 Carrier gas: 0.6 bar He
 Temperature: 40 °C (5 min) → 390 °C, 50 °C/min
 Detector: FID 280 °C

Peaks:

1. Decane (C10)
2. Tetracontane (C40)

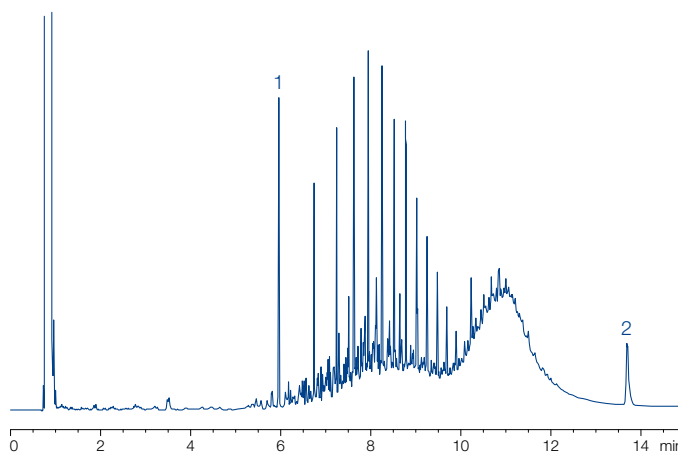

OPTIMA® 5 HT

	Length → 15 m	30 m
0.25 mm ID (0.4 mm OD)		
0.10 µm film	726102.15	726102.30
0.25 µm film	726106.15	726106.30
0.32 mm ID (0.5 mm OD)		
0.10 µm film	726104.15	726104.30
0.25 µm film	726108.15	726108.30

Further applications can be found online in our application database at ChromaAppDB.mn-net.com



OPTIMA® 5 Amine special column for analysis of amines · USP G27 / G36

★ Key features

- Nonpolar phase
- Improved linearity for analysis of active components at trace levels: no amine absorptions even for aliphatic and aromatic amines at concentrations of 100 pg/peak
- Tested with the OPTIMA® Amine test mixture (REF 722317), which contains, amongst others, diethanolamine and propanol-pyridine (this test mixture is supplied with each column)

✓ Recommended application

- Especially deactivated for the analysis of polyfunctional amines such as ethanolamines, amino-functionalized diols and similar compounds; which are important base materials in industrial chemistry, and show strong tailing on standard-deactivated columns

✍ Temperature

- T_{max} 300 °C (long-term temperature), T_{max} 320 °C (short-term max. temperature in a temperature program)

Similar phases

- Rtx®-5 Amine, PTA-5

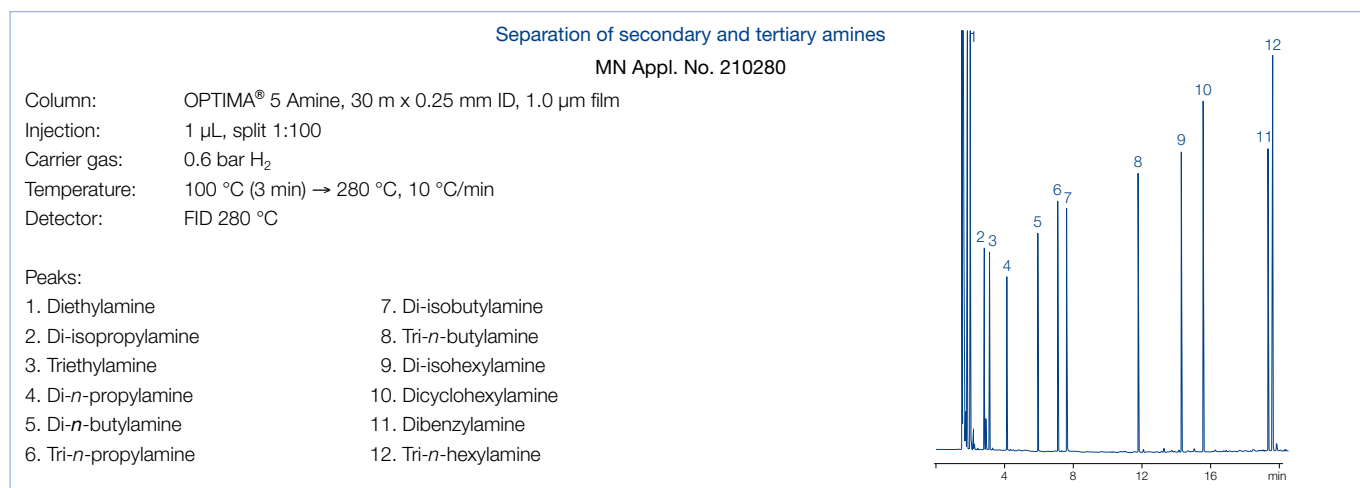

OPTIMA® 5 Amine

	Length → 10 m	25 m	30 m
0.1 mm ID (0.4 mm OD)			
0.40 µm film	726361.10		
0.2 mm ID (0.4 mm OD)			
0.35 µm film		726355.25	
0.25 mm ID (0.4 mm OD)			
0.50 µm film			726354.30
1.00 µm film			726358.30
0.32 mm ID (0.5 mm OD)			
0.25 µm film			726360.30
1.00 µm film			726353.30
1.50 µm film			726356.30
0.53 mm ID (0.8 mm OD)			
1.00 µm film			726359.30
3.00 µm film			726357.30



Capillary columns for amine separation

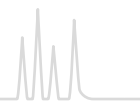

FS-CW 20 M-AM polyethylene glycol 20 000, non-immobilized · USP G16

★ Key features

- Polyethylene glycol, basic for amine separations

✍ Temperature

- T_{\max} 220 °C (long-term temperature),
 T_{\max} 240 °C (short-term max. temperature in a temperature program)

Similar phases

- Carbowax™ Amine, CP-Wax 51, CAM, Stabilwax® DB

FS-CW 20 M-AM

	Length → 10 m	25 m	50 m
0.1 mm ID (0.4 mm OD)			
0.25 µm film	733111.10		
0.25 mm ID (0.4 mm OD)			
0.25 µm film		733110.25	733110.50
0.32 mm ID (0.5 mm OD)			
0.25 µm film		733299.25	733299.50
0.35 µm film			733442.50
0.53 mm ID (0.8 mm OD)			
1.00 µm film		733551.25	

Further applications can be found online in our application database at ChromaAppDB.mn-net.com



MACHEREY-NAGEL

CHROMAFIL® syringe filters

Ideal for the filtration of GC, HPLC and UHPLC sample solutions

- Diverse membrane types and filter sizes for a variety of applications
- Optimal flow geometry because of star-shaped distribution device
- Lowest content of extractable substances
- Luer lock inlet, Luer outlet
- Prefiltration of solvents protects sensitive instrument parts and chromatography columns from solid contamination and increases their lifetime.

Find CHROMAFIL® products from page 86 onwards.





PERMABOND® P-100 for analysis of petrochemical products · USP G1 / G2 / G38

★ Key features

- Extra long column with nonpolar dimethylpolysiloxane phase

✓ Recommended application

- High resolution and sufficient capacity for analysis of complex mixtures of hydrocarbons

✍ Temperature

- T_{\max} 300 °C (long-term temperature),
 T_{\max} 320 °C (short-term max. temperature in a temperature program)

PERMABOND® P-100

Length →	
100 m	
0.25 mm ID (0.4 mm OD)	
0.50 µm film	723890.100

PERMABOND® SE-54-HKW for volatile halogenated hydrocarbons · USP G36

✓ Recommended application

- SE-54 optimized for volatile halogenated hydrocarbons

✍ Temperature

- T_{\max} 300 °C (long-term temperature),
 T_{\max} 320 °C (short-term max. temperature in a temperature program)

For the analysis of halogenated hydrocarbons, we recommend our optimized column PERMABOND® SE-54-HKW at 25 or 50 m length with our approved polysiloxane phase SE-54.

As an alternative, or to verify analytical results, the OPTIMA® 624 has proven itself as advantageous, especially for the determination of 1,1,2-trichlorotrifluoroethane (F 113) along with dichloromethane.

Both phases are also suited for the determination of vinyl chloride as well as for the separation of cis/trans isomers of 1,2-dichloroethene. The high film thickness secures a high capacity and an outstanding resolution. For GC/MS coupling, we recommend OPTIMA® 624 LB or OPTIMA® 624 with 0.2 or 0.25 mm ID.

Volatile halogenated hydrocarbons

MN Appl. No. 212480

Column: PERMABOND® SE-54-HKW, 50 m x 0.32 mm ID
 Injection: 1 µL, split ~ 1:30
 Carrier gas: 0.9 bar He
 Temperature: 35 °C (25 min) → 160 °C (5 min), 10 °C/min
 Detector: ECD 300 °C

Peaks:

1. Dichloromethane (795 ng/mL)
2. Trichloromethane (75 ng/mL)
3. 1,1,1-Trichloroethane (67 ng/mL)
4. 1,2-Dichloroethane (100 ng/mL)
5. Tetrachloromethane (15.9 ng/mL)
6. Trichloroethene (14.6 ng/mL)
7. Bromodichloromethane (20 ng/mL)
8. Dibromochloromethane (122 ng/mL)
9. Tetrachloroethene (81 ng/mL)
10. Tribromomethane (28.9 ng/mL)

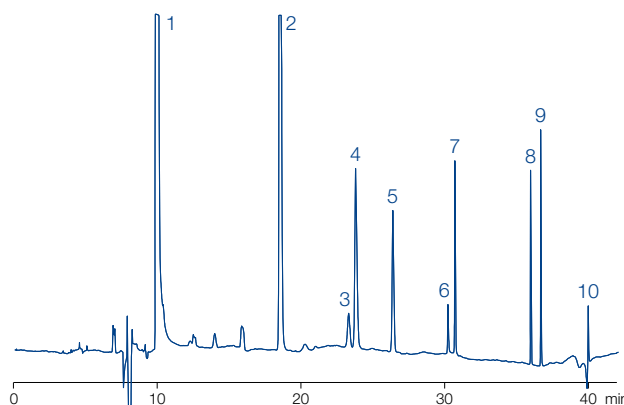



Capillary columns for hydrocarbons

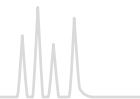

Volatile halogenated hydrocarbons and BTX

MN Appl. No. 200160

Column: OPTIMA® 624, 50 m x 0.25 mm ID, 1.40 µm film
Injection: 1 µL, split 50 mL/min
Carrier gas: 0.9 mL/min He (constant flow)
Temperature: 40 °C (5 min) → 160 °C, 10 °C/min
Detector: MSD 5971

Peaks:

- | | |
|---|-----------------------------------|
| 1. Vinyl chloride | 12. 1,2-Dichloroethane + benzene |
| 2. Trichlorofluoromethane (F 11) | 13. Trichloroethene |
| 3. Pentane | 14. Bromodichloromethane |
| 4. 1,1,2-Trichlorotrifluoroethane (F 113) | 15. Toluene |
| 5. Dichloromethane | 16. Tetrachloroethene |
| 6. <i>trans</i> -1,2-Dichloroethene | 17. Dibromochloromethane |
| 7. Hexane | 18. Chlorobenzene |
| 8. <i>cis</i> -1,2-Dichloroethene | 19. Ethylbenzene |
| 9. Trichloromethane | 20. <i>m</i> - + <i>p</i> -Xylene |
| 10. 1,1,1-Trichloroethane | 21. <i>o</i> -Xylene |
| 11. Tetrachloromethane | 22. Tribromomethane |
| | 23. Bromobenzene |

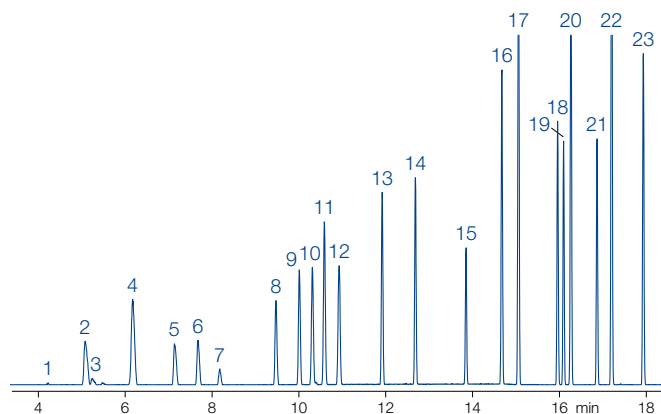

PERMABOND® SE-54-HKW

	Length → 25 m	50 m
0.32 mm ID (0.5 mm OD)		
1.80 µm film	723945.25	723945.50

Further applications can be found online in our application database at ChromaAppDB.mn-net.com



PERMABOND® Silane for silane analysis

✓ Recommended application

- Developed especially for the analysis of monomeric silanes and chlorosilanes (not for the separation of trimethylsilyl derivatives)
- Also suited for the separation of dimeric siloxanes and silazanes

✍ Temperature

- 0.32 mm ID: T_{max} 260 °C (long-term temperature), T_{max} 280 °C (short-term max. temperature in a temperature program)
- 0.53 mm ID: T_{max} 240 and 260 °C, resp.

PERMABOND® Silane

	Length → 25 m	50 m
0.32 mm ID (0.5 mm OD)		723409.50
0.53 mm ID (0.8 mm OD)	723411.25	

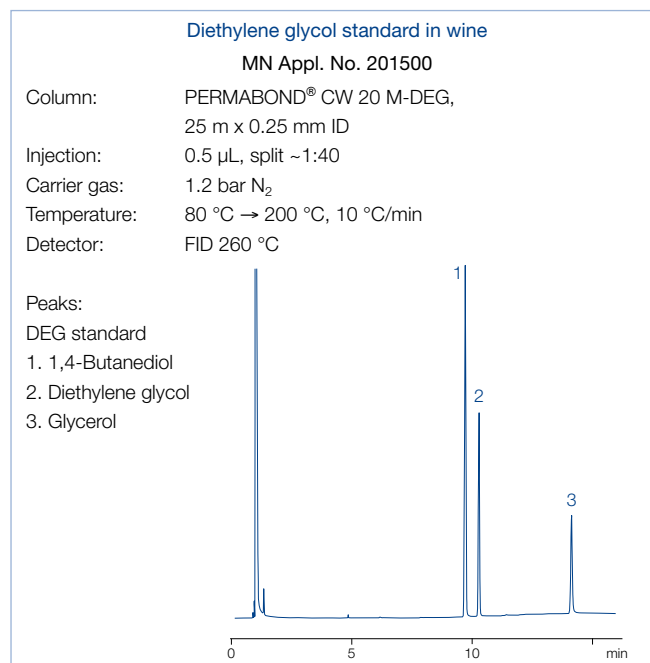
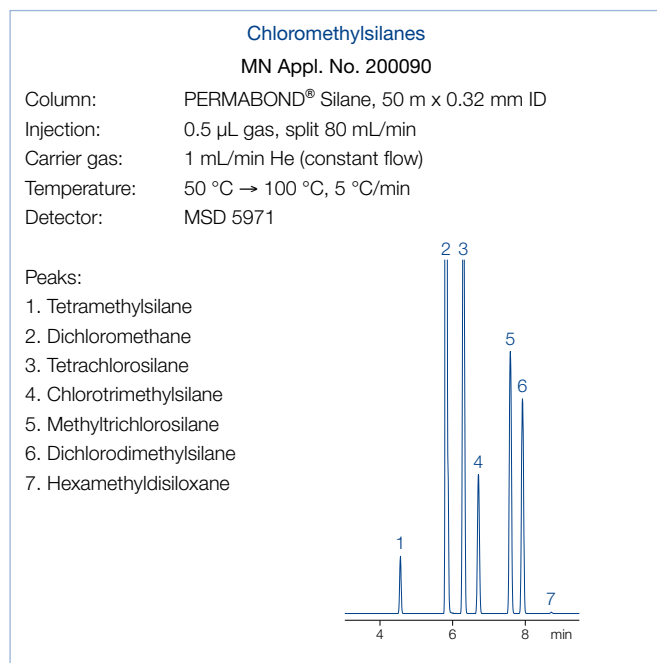

PERMABOND® CW 20 M-DEG for determination of diethylene glycol · USP G16

★ Key features

- Polyethylene glycol 20,000 (diethylene glycol tested)

✓ Recommended application

- Determination of diethylene glycol (DEG), e.g., for the quality control of wine

✍ Temperature

- T_{max} 220 °C (long-term temperature), T_{max} 240 °C (short-term max. temperature in a temperature program)

PERMABOND® CW 20 M-DEG

	Length → 25 m
0.25 mm ID (0.4 mm OD)	
0.25 µm film	723063.25
0.32 mm ID (0.5 mm OD)	
0.25 µm film	723327.25

Further applications can be found online in our application database at ChromaAppDB.mn-net.com

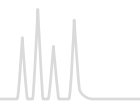

Untreated capillaries

- ✓ Recommended application
 - Capillary electrophoresis
 - Preparation of capillary columns
 - Capillary LC applications

Untreated capillaries

	Length → 1 m Pack of 3	10 m Pack of 1	25 m Pack of 1
Capillaries for electrophoresis			
0.025 mm ID (0.4 mm OD)	723793.1	723793.2	
0.05 mm ID (0.4 mm OD)	723790.1	723790.2	
0.075 mm ID (0.4 mm OD)	723791.1	723791.2	
0.10 mm ID (0.4 mm OD)	723792.1	723792.2	
Untreated capillaries			
0.20 mm ID (0.4 mm OD)		723148.10	723148.25
0.25 mm ID (0.4 mm OD)		723101.10	723101.25
0.32 mm ID (0.5 mm OD)		723151.10	723151.25
0.53 mm ID (0.8 mm OD)		723501.10	723501.25

Untreated capillaries are supplied without cage.

Deactivated capillary columns precolumns/guard columns

- ✓ Recommended application
 - As precolumns/guard columns, whenever a larger contamination capacity is required
 - Preparation of capillary columns

Deactivated capillary columns

	Length → 10 m	25 m
Methyl-Sil deactivated (T_{max} 320 °C)		
0.25 mm ID (0.4 mm OD)	723106.10	723106.25
0.32 mm ID (0.5 mm OD)	723346.10	723346.25
0.53 mm ID (0.8 mm OD)	723558.10	723558.25
Phenyl-Sil deactivated (T_{max} 320 °C)		
0.25 mm ID (0.4 mm OD)	723108.10	723108.25
0.32 mm ID (0.5 mm OD)	723348.10	723348.25
0.53 mm ID (0.8 mm OD)	723560.10	723560.25
CW deactivated (T_{max} 250 °C)		
0.25 mm ID (0.4 mm OD)	723105.10	723105.25
0.32 mm ID (0.5 mm OD)	723349.10	723349.25
0.53 mm ID (0.8 mm OD)	723562.10	723562.25

Untreated capillaries are supplied without cage.

For a considerably longer lifetime, even for contaminated or matrix-containing samples, MN offers the option of integrated precolumns. All capillary columns are available with a 10 m guard column with matched deactivation. For ordering, please add V1 at the end of the REF number. Guard column combinations with other lengths, IDs or different deactivation are available on request.

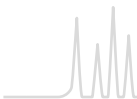

Retention gaps

★ Key features

- The retention gap technique in combination with on-column injection allows to concentrate a large sample volume in the capillary column.
- Choice of the retention gap depends on the solvent used: the flooded zone after injection should be between 20–30 cm/μL
- Me-Sil retention gap:
only for use with *n*-hexane and diethyl ether
- Phe-Sil retention gap:
for all solvents except methanol and water
- CW retention gap:
for all solvents and especially for methanol and water

Note:

- Calculation example: length of flooded zone ~ 20–30 cm/μL, retention gap 10 m x 0.32 mm ID, capillary column: 25 m x 0.32 mm ID, max. injection volume ~ 30–50 μL
- A retention gap must be inert without any noticeable retention: Me-Sil retention gaps are more inert than Phe-Sil, while Phe-Sil is less susceptible to contamination
- Retention gaps can also be used as transfer lines or precolumns (contamination capacity about 5–10 μg).

✍ Temperature

- T_{max} 250 °C (CW retention gaps),
T_{max} 320 °C (Me-Sil and Phe-Sil retention gaps)

Retention gaps

	Length →	
	10 m	25 m
Me-Sil retention gaps (T_{max} 320 °C)		
0.25 mm ID (0.4 mm OD)	723706.10	723706.25
0.32 mm ID (0.5 mm OD)	723707.10	723707.25
0.53 mm ID (0.8 mm OD)	723708.10	723708.25
Phe-Sil retention gaps (T_{max} 320 °C)		
0.25 mm ID (0.4 mm OD)	723709.10	723709.25
0.32 mm ID (0.5 mm OD)	723710.10	723710.25
0.53 mm ID (0.8 mm OD)	723711.10	723711.25
CW retention gaps (T_{max} 250 °C)		
0.25 mm ID (0.4 mm OD)	723712.10	723712.25
0.32 mm ID (0.5 mm OD)	723713.10	723713.25
0.53 mm ID (0.8 mm OD)	723714.10	723714.25
Retention gaps are supplied without cage.		

For a considerably longer lifetime, even for contaminated or matrix-containing samples, MN offers the option of integrated precolumns. All capillary columns are available with a 10 m guard column with matched deactivation. For ordering, please add V1 at the end of the REF number. Guard column combinations with other lengths, IDs or different deactivation are available on request.

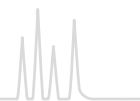

Derivatization reagents

★ Key features

- Derivatization reagents: To improve volatility, increase thermal stability or to achieve a lower limit of detection in gas chromatography
- Prerequisite: quantitative, rapid and reproducible formation of only one derivative
- Halogen atoms inserted by derivatization, e.g., trifluoroacetates, allow the specific detection in an ECD with the advantage of high sensitivity.
- Specific derivatizations may influence elution orders and fragmentation patterns in a MS
- We provide reagents for
 - acylation
 - alkylation (methylation)
 - silylation
- For 1 × 10 mL, 1 × 50 mL and 6 × 50 mL also available with screw closure

Derivatization method development kits*

Designation	Contents of the kit	REF
Which type of derivatization is suited best for your sample (alkylation, acylation or silylation)?	2 × 1 mL each of TMSH, MSTFA, MBTFA	701952
Acylation kit		
Which is the proper reagent for acylation?	2 × 1 mL each of MBTFA, TFAA, MBHFBA	701950
Alkylation kit		
Which is the proper reagent for methylation?	3 × 1 mL each of TMSH, DMF-DMA	701951
Silylation kit		
Which is the proper reagent for silylation?	2 × 1 mL each of MSTFA, BSTFA, TSIM, MSHFBA	701953

* These products contain harmful substances which must be specially labeled as hazardous. For detailed information please see SDS.

Selection guide for derivatization of important functional groups in GC

Function	Method	Derivative	Recommended reagents
alcohols, phenols R'OH	silylation	R'O-TMS	BSA, MSTFA, MSHFBA, TSIM, SILYL-2110, SILYL-21, SILYL-1139
sterically hindered	acylation	R'O-CO-R	TFAA, HFBA, MBTFA, MBHFBA
	alkylation	R'O-R	TMSH
amines primary, secondary hydrochlorides	silylation	R'-NR''-TMS	TSIM, BSTFA, SILYL-991
	acylation	R'-NR''-CO-R	BSA, MSTFA, MSHFBA, SILYL-991
	silylation	R'-NR''-TMS	TFAA, HFBA, MBTFA, MBHFBA
amides	silylation	not stable	MSTFA
	acylation	R'-CO-NH-CO-R	TFAA, MBTFA, HFBA, MBHFBA
amino acids	silylation	R'-CH(NH-TMS)-CO-O-TMS	BSA, BSTFA, MSTFA, MSHFBA
	alkylation (a)	R'-CH(NH-CO-R)-CO-O-R	a) MeOH/TMCS, TMSH
	+ acylation (b)		b) TFAA, HFBA, MBTFA, MBHFBA
Carboxylic acids (fatty acids)	silylation	R'-CO-O-TMS	BSA, MSTFA, MSHFBA, TMCS, TSIM, SILYL-2110, SILYL-21, Silyl-1139
	alkylation	R'-CO-O-R	DMF-DMA, MeOH/TMCS (1 M), TMSH
salts	silylation	R'-CO-O-TMS	TMCS
		susceptible to hydrolysis	
carbohydrates	silylation		MSTFA, TSIM, HMDS, SILYL-1139
	acylation		TFAA, MBTFA
steroids	silylation		BSA, TSIM
	acylation		TFAA, MBTFA, HFBA, MBHFBA

These products contain harmful substances which must be specially labeled as hazardous. For detailed information please see SDS.

Due to their purpose, derivatization reagents are very reactive substances. For this reason, they should be stored cool and protected from moisture. For easy access with a syringe, our derivatization reagents are supplied in vials with crimp caps (exception DMCS and TMCS with screw closure). Vials with pierced sealing disks have limited stability and should be used soon.

The derivatization procedures can be found on page 372.



General reaction mechanisms

Silylation

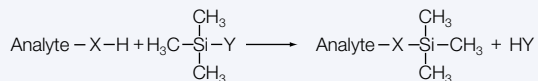

X = e.g., O, S, COO, etc.

Y = rest of silylation reagents

Acylation



X = e.g., O, S, NH, etc.

Y = rest of acylation reagents

Alkylation (Methylation) · example TMSH

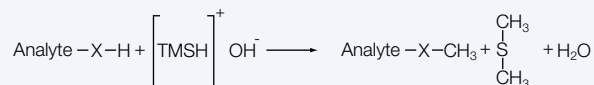

X = e.g., O, S, COO, etc.



MACHEREY-NAGEL

derivatization reagents for GC

Content of brochure

- Product range for acylation, alkylation and silylation reagents
 - Protocols for derivatization
 - Diverse tips and hints
- Order your derivatization brochure KATEN200144 now

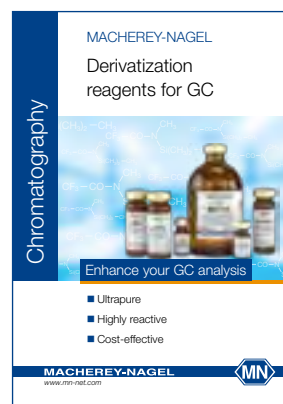

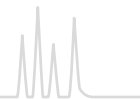

Acylation reagents

Acyl halides

★ Key features

- By-product of acylation with acyl halides: corresponding hydrohalic acids excess of reagent and acid have to be removed or trapped by a suitable base (e.g., pyridine)
- Pentafluorobenzoyl chloride
PFBC: $C_6F_5-CO-Cl$
M 230.52 g/mol, Bp 158 – 159 °C (760 mm Hg),
Density $d_{20^\circ/4^\circ} = 1.601$

Anhydrides

★ Key features

- By-products of acylation with anhydrides: corresponding acids excess reagent and the acid formed are to be removed
- Trifluoroacetic acid anhydride TFAA: $CF_3-CO-O-CO-CF_3$
M 210.04 g/mol, Bp 39.5 – 40.5 °C (760 mm Hg),
Density $d_{20^\circ/4^\circ} = 1.490$
- Heptafluorobutyric acid anhydride
HFBA: $C_3F_7-CO-O-CO-C_3F_7$
M 410.06 g/mol, Bp 106 – 107 °C (760 mm Hg),
Density $d_{20^\circ/4^\circ} = 1.665$

Bisacylamides

★ Key features

- By-products: corresponding neutral acylamides: high volatility
- Easily removed; due to the neutral conditions and their favorable chromatographic characteristics, the removal of surplus bisacylamides and their by-products is often not necessary. Therefore, the sample preparation is much easier.
- *N*-methyl-bis(trifluoroacetamide)
MBTFA: $CF_3-CO-N(CH_3)-CO-CF_3$
M 223.08 g/mol, Kp 123 – 124 °C (760 mm Hg),
Density $d_{20^\circ/4^\circ} = 1.55$
- *N*-methyl-bis(heptafluorobutyramide)
MBHFBA: $C_3F_7-CO-N(CH_3)-CO-C_3F_7$
M 423.1 g/mol, Kp 165 – 166 °C (760 mm Hg),
Density $d_{20^\circ/4^\circ} = 1.673$

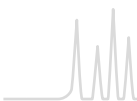

Methods for acylation

Acylation with fluorinated acid anhydrides (TFAA, HFBA)

- Applicable for alcohols, phenols, carboxylic acids, amines, amino acids and steroids, stable derivatives for FID or ECD detection
- Procedure see page 372 or online at ChromaAppDB.mn-net.com
TFAA: MN Appl. Nr. 213041
HFBA: MN Appl. Nr. 213042

Acylation with fluorinated acid amides (MBTFA, MBHFBA)

- Recommended for alcohols, primary and secondary amines as well as for thiols under mild, neutral conditions
- MBTFA also forms very volatile derivatives with carbohydrates [17]
- Procedure see page 372 or online at ChromaAppDB.mn-net.com
MBTFA: MN Appl. Nr. 213051
MBHFBA: MN Appl. Nr. 21305

Acylation reagents*

Substance	Packing unit			
	10 × 1 mL	20 × 1 mL	1 × 10 mL	5 × 10 mL
HFBA		701110.201	701110.110	701110.510
MBTFA		701410.201	701410.110	701410.510
MBHFBA	701420.101	701420.201		
PFBC	701120.101			
TFAA			701130.110	701130.510

* These products contain harmful substances which must be specially labeled as hazardous. For detailed information please see SDS.

On request for 1 × 10 mL, 1 × 50 mL and 6 × 50 mL also available with screw closure.

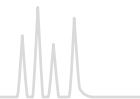

Alkylation / methylation reagents

DMF-DMA *N,N*-dimethylformamide dimethylacetal

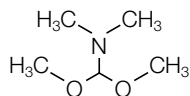

★ Key features

- Methylation reagents

- M 119.17 g/mol,
Kp 106 – 107 °C
(760 mm Hg),
Density d_{20°/4°} = 0.897

TMSH (0.2 mol/L in methanol) Trimethylsulfonium hydroxide

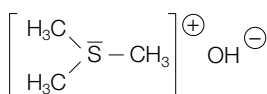

★ Key features

- Methylation reagents

- M 94.06 g/mol

Methods for alkylation / methylation

Methylation with TMSH

- Suited for free acids, chlorophenoxy-carboxylic acids, their salts and derivatives as well as for phenols and chlorophenols [18]
- The great advantage is the simplification of the sample preparation. Lipids or triglycerides can be converted to the corresponding fatty acid methyl esters (FAMES) by simple transesterification.
- This reaction is very elegant and convenient, because it is only necessary to add the reagent (0.2 mol/L in methanol) to the sample solution. Removal of surplus reagent is not required, since at 250 °C inside the injector of the gas chromatograph, TMSH will pyrolyze solely to volatile methanol and dimethylsulfide. Due to high reactivity, a complete conversion is usually obtained at ambient temperature. Heating (e.g., 10 min at 100 °C) in a closed sample vial may be necessary, however.
- Procedure see page 372 or online at ChromaAppDB.mn-net.com
MN Appl. Nr. 213060

Methylation with DMF-DMA

- Applicable for fatty acids, primary amines and (partially) amino acids, under formation of *N*-dimethyl-aminomethylene amino acid methyl esters [19]
- Since DMF-DMA is a poor solvent, it is essential to use a mixture of DMF-DMA with pyridine, THF, acetone (barbiturates) or another solvent.
- Procedure see page 372 or online at ChromaAppDB.mn-net.com
MN Appl. Nr. 213070

Methylation with methanol – TMCS (1 M)

- Suited for the esterification of free carboxylic acids and the transesterification of glycerides. Formation of HCl catalyzes the reaction. TMCS, resp. silyl ethers remove the water and thus drive the reaction to completion. The mixture should be freshly prepared.
- Procedure see page 372 or online at ChromaAppDB.mn-net.com
MN Appl. Nr. 213080

For GC separation of FAMES from natural butter fat after derivatization with TMSH see Appl. 201680 at ChromaAppDB.mn-net.com

Alkylation reagents*

Substance	Packing unit			
	10 × 1 mL	20 × 1 mL	1 × 10 mL	5 × 10 mL
DMF-DMA		701430.201	701430.110	
TMSH	701520.101	701520.201	701520.110	701520.510

* These products contain harmful substances which must be specially labeled as hazardous. For detailed information please see SDS.
On request for 1 × 10 mL, 1 × 50 mL and 6 × 50 mL also available with screw closure.



Silylation reagents

The most common form of silylation in GC is the replacing of active hydrogen atoms with a trimethylsilyl group (TMS derivative). Less frequently, trialkylsilyl groups or dimethylsilyl groups with longer alkyl chains are also in use. The alkylsilyl group increases volatility and enhances thermal stability of the sample.

Silylation can be catalyzed either acidic by addition of TMCS or basic by addition of pyridine or TSIM (e.g., for sterically hindered functionalities like tert. alcohols).

Reactivity of silylation reagents (acc. to M. Donike): TMS amide (e.g., BSA, MSTFA) > TMS amine = TSIM > Enol-O-TMS ether > S-TMS ether > O-TMS ether > TMS-O-TMS

Stability of the TMS derivatives: O-TMS ether > S-TMS ether > Enol-O-TMS ether > TMS amine > TMS amide

BSA N,O-bis-trimethylsilyl-acetamide

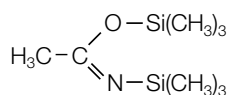

- M 203.4 g/mol,
Bp 71–73 °C (35 mm Hg),
Density d_{20°/4°} = 0.832

★ Key features

- Strong silylation reagent
- Not recommended for use with carbohydrates or very low molecular weight compounds
- Good solvent for polar compounds, but frequently used in combination with a solvent (pyridine, DMF etc.) or with other silylation reagents. Dissolved in DMF, BSA is the prime derivatization reagent for phenols.

✓ Recommended application

- Alcohols, amines, carboxylic acids, phenols, steroids, biogenic amines and alkaloids are derivatized to stable TMS derivatives

BSTFA N,O-bis-trimethylsilyl-trifluoroacetamide

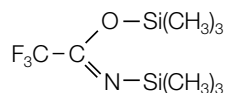

- M 257.4 g/mol,
Bp 40 °C (12 mm Hg),
Density d_{20°/4°} = 0.961

★ Key features

- Powerful trimethylsilyl donor with approx. the same donor strength as the nonfluorinated analog BSA
- Advantage of BSTFA over BSA: greater volatility of its reaction products, particularly useful for GC analysis of low boiling TMS amino acids

- BSTFA is nonpolar (less polar than MSTFA) and can be mixed with acetonitrile for improved solubility. For the silylation of fatty acid amides, hindered hydroxyl groups and other difficult to silylate compounds, e.g., secondary alcohols and amines, we recommend BSTFA + 1 % trimethylchlorosilane (TMCS), available under the designation SILYL-991 (see page 371).

Silylation with BSA, BSTFA or SILYL-991 (BSTFA + 1 % TMCS)

- Procedure see page 372 or online at ChromaAppDB.mn-net.com
BSA MN Appl. Nr. 213091
BSTFA MN Appl. Nr. 213092
SILYL-991 MN Appl. Nr. 213093

Silylation with BSA in combination with other silylation reagents

- Procedure see page 372 or online at ChromaAppDB.mn-net.com
MN Appl. Nr. 213100

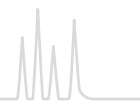

Silylation reagents*

Substance	Packing unit				
	20 × 1 mL	1 × 10 mL	5 × 10 mL	1 × 50 mL	1 × 100 mL
BSA		701210.110	701210.510	701210.150	
BSTFA	701220.201	701220.110	701220.510		
SILYL-991 (BSTFA – TMCS (99:1))	701490.201			701490.150	701490.1100

* These products contain harmful substances which must be specially labeled as hazardous. For detailed information please see SDS.
On request for 1 × 10 mL, 1 × 50 mL and 6 × 50 mL also available with screw closure.

MSTFA N-methyl-N-trimethylsilyl-trifluoroacetamide

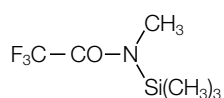

▪ M 199.1 g/mol,
Bp 70 °C (75 mm Hg),
Density $d_{20}^{20}/4^\circ = 1.11$

★ Key features

- The most volatile trimethylsilyl amide available, very strong TMS donor which does not cause noticeable FID fouling even during long-time measuring series

✓ Recommended application

- Carboxylic acids, hydroxy and ketocarboxylic acids, amino acids, amines, alcohols, polyalcohols, sugars, mercaptans and similar compounds with active hydrogen atoms. Even amine hydrochlorides can be silylated directly.

- The addition of protic solvents in submolar quantities, e.g., TFA for extremely polar compounds (hydrochlorides) or pyridine for carbohydrates), can improve the already good dissolving power of MSTFA.
- Advantages: complete conversion with high reaction rates, even without a catalyst (1–2 % TMCS or TSIM); the by-product of the reaction (*N*-methyltrifluoroacetamide) shows a high volatility and a short retention time

MSHFBA N-methyl-N-trimethylsilyl-heptafluorobutyramide

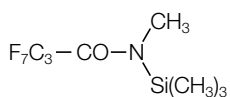

▪ M 299.1 g/mol,
Bp 148 °C (760 mm Hg)

★ Key features

- Similar to MSTFA in reactivity and chromatography
- Either applied alone or in combination with a catalyst (TMCS, TSIM) or another silylation reagent with or without solvent; the by-product *N*-methylheptafluorobutyric amide has a lower retention time than the silylating reagent

✓ Recommended application

- Carboxylic acids, alcohols, phenols, primary and secondary amines and amino acids

- Especially useful for flame ionization detection due to the large ratio of fluorine to silicon of 7:1, since degradation of the surplus MSHFBA does not produce SiO₂ but volatile, non-corrosive silicon compounds

MBDSTFA N-methyl-N-tert-butyl dimethylsilyl-trifluoroacetamide

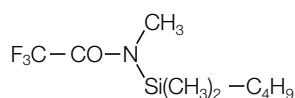

▪ M 241.3 g/mol,
Bp 170 °C (760 mm Hg),
Density $d_{20}^{20}/4^\circ = 1.121$

★ Key features

- Silylation reagent that donates a *tert*-butyldimethylsilyl group (TBDMS) for derivatizing active hydrogen atoms in hydroxyl, carboxyl and thiol groups as well as primary and secondary amines
- Fast reactions (typically 5–20 min) with high yields (> 96 %), by-products are neutral volatiles

- TBDMS ethers are 10⁴ times more stable than the corresponding TMS ethers
- Due to the large protecting group, chromatographic retention times are longer. This may have a beneficial impact on some separations. The high concentration of M⁺-57 ions is an interesting topic for GC/MS.

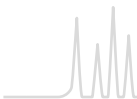

Reagents / methods for silylation



Silylation with MSTFA, MSHFBA or MBDSTFA

- Procedure see page 372 or online at ChromaAppDB.mn-net.com
 MSTFA MN Appl. Nr. 213111 · MSHFBA MN Appl. Nr. 213112 · MBDSTFA MN Appl. Nr. 213113

Silylation reagents*

Substance	Packing unit							
	10 × 1 mL	20 × 1 mL	1 × 10 mL	5 × 10 mL	1 × 100 mL	6 × 50 mL	6 × 100 mL	12 × 100 mL
MSTFA		701270.201	701270.110	701270.510	701270.1100	701270.650	701270.6100	701270.12100
MSHFBA		701260.201	701260.110	701260.510	701260.1100		701260.6100	
MBDSTFA		701440.101	701440.201					

* These products contain harmful substances which must be specially labeled as hazardous. For detailed information please see SDS.

On request for 1 × 10 mL, 1 × 50 mL and 6 × 50 mL also available with screw closure.



Ultrapure derivatization reagents for acylation, alkylation and silylation.

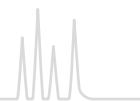

DMCS Dimethyldichlorosilane

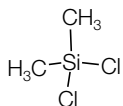

- M 129.06 g/mol,
Bp 70 °C (760 mm Hg),
Density $d_{20^\circ/4^\circ} = 1.07$

★ Key features

- Used to form dimethylsilyl (DMS) derivatives
- DMS derivatives are much more susceptible to hydrolysis than TMS derivatives, it is therefore vital to have strictly anhydrous conditions during the conversion.

HMDS Hexamethyldisilazane

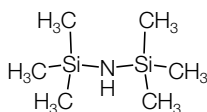

- M 161.4 g/mol,
Bp 126 °C (760 mm Hg),
Density $d_{20^\circ/4^\circ} = 0.7742$

★ Key features

- Weak TMS donor; used as a sole reagent, it is slow and not very effective.
- Aprotic solvents like acetonitrile, pyridine, dimethylformamide, carbon disulfide and dimethylacetamide recommend themselves for use with HMDS.
- With catalytic quantities, e.g., 1 % of, or as a mixture with TMCS (2:1, v/v; SILYL-21 and SILYL-2110) it is perfectly suited for a quick and quantitative trimethylsilylation of organic compounds.

TMCS Trimethylchlorosilane

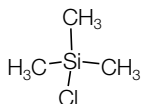

- M 108.7 g/mol,
Bp 57 °C (760 mm Hg),
Density $d_{20^\circ/4^\circ} = 0.8580$

★ Key features

- Often used as a catalyst with other trimethylsilyl reagents
- As a sole reagent, it can be used to prepare TMS derivatives of organic acids.

TSIM N-trimethylsilyl-imidazole

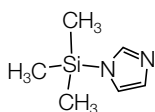

- M 140.3 g/mol,
Bp 94–96 °C (760 mm Hg),
Density $d_{20^\circ/4^\circ} = 0.961$

★ Key features

- Strongest hydroxyl silylator
- It is remarkable that TSIM reacts quickly and smooth with hydroxyl (even tert. OH) and carboxyl groups, but not with amines. Hence it is especially suited for multiple derivatizations, when compounds with various functional groups are to be derivatized in different ways (e.g., -O-TMS, -N-HFB derivatives of catecholamines).
- ✓ Recommended application
- Alcohols, phenols, organic acids, steroids, hormones, glycols, nucleotides, narcotics
- Reagent of choice for carbohydrates and most steroids (even strongly hindered steroids)

Silylation with TSIM or SILYL-1139 (TSIM – pyridine 11:39)

- Procedure see page 372 or online at ChromaAppDB.mn-net.com
TSIM: MN Appl. Nr. 213121
SILYL-1139: MN Appl. Nr. 213122



Silylation reagents*

Substance	Packing unit			
	20 × 1 mL	1 × 10 mL	5 × 10 mL	6 × 50 mL
DMCS				701230.650
HMDS			701240.510	701240.650
TMCS	701280.201			701280.650
TSIM	701310.201	701310.110	701310.510	

* These products contain harmful substances which must be specially labeled as hazardous. For detailed information please see SDS.

On request for 1 × 10 mL, 1 × 50 mL and 6 × 50 mL also available with screw closure.

Reagent mixtures for silylation*

Mixture	Composition	Packing unit				
		20 × 1 mL	1 × 10 mL	5 × 10 mL	1 × 50 mL	1 × 100 mL
SILYL-271	BSA – HMDS – TSIM (2:7:1)	701450.201	701450.110	701450.510		
SILYL-1139	TSIM – Pyridine (11:39)	701460.201				
SILYL-21	HMDS – TMCS (2:1)	701470.201				
SILYL-2110	HMDS – TMCS – Pyridine (2:1:10)	701480.201				
SILYL-991	BSTFA – TMCS (99:1)	701490.201			701490.150	701490.1100

* These products contain harmful substances which must be specially labeled as hazardous. For detailed information please see SDS.

On request for 1 × 10 mL, 1 × 50 mL and 6 × 50 mL also available with screw closure.

Due to their purpose, derivatization reagents are very reactive substances. For this reason, they should be stored cool and protected from moisture. For easy access with a syringe, our derivatization reagents are supplied in vials with crimp caps (exception DMCS and TMCS with screw closure). Vials with pierced sealing disks have limited stability and should be used soon.

Silylation with SILYL-21 or SILYL-2110

- Recommended applications: sugars, glycols, sterically unhindered alcohols, carboxylic acids, acids in urine, hydroxy fatty acids, nucleotides, steroids, vitamin D, xanthone derivatives
- Procedure see page 372 or online at ChromaAppDB.mn-net.com
 SILYL-21 MN Appl. Nr. 213131
 SILYL-2110 MN Appl. Nr. 213132

O-trimethylsilylation with MSTFA followed by N-trifluoroacetylation with MBTF

- Procedure see page 372 or online at ChromaAppDB.mn-net.com
 MSTFA/MBTFA MN Appl. Nr. 213140



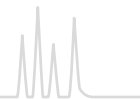

Acylation

with fluorinated acid anhydrides · TFAA MN Appl. No. 213041 · HFBA MN Appl. No. 213042

- Dissolve 0.1 to 1 mg sample in 0.1 mL solvent, add 0.1 mL of the anhydride and heat to 60–70 °C for 1–2 h. If the sample does not need to be concentrated prior to the analysis and if there is no danger of catalytically induced side reactions, pyridine is used as solvent. The reaction solution can be injected directly into the gas chromatograph. Otherwise, use a volatile solvent and evaporate solvent, excess reagent and free acid in a stream of nitrogen. Dissolve residue in 50 µL hexane, chloroform etc. and inject aliquot portions.

with fluorinated acid amides · MBTFA MN Appl. No. 213051 · MBHFBA MN Appl. No. 213052

- Add 0.5 mL MBTFA or MBHFBA to about 2 mg sample. If there is no reaction at ambient temperature, heat the reaction mixture to 120 °C. Compounds difficult to dissolve, can be trifluoroacetylated in suitable solvent mixtures. It is recommended to use a ratio of solvent to MBTFA or MBHFBA of 4:1. The reaction mixture is chromatographed directly.

Alkylation (Methylation)

with TMSH · MN Appl. No. 213060

- Dissolve 100 mg sample (e.g., butter) in 5 mL of a solvent (e.g., *tert.*-butyl methyl ether). Add 50 µL reagent to 100 µL of this solution. The mixture is injected directly. The temperature of the injector must be at least 250 °C.

with DMF-DMA · MN Appl. No. 213070

- Add 1 mL of a mixture of DMF-DMA and pyridine (1:1) to 1–50 mg fatty acids. The sample can be injected as soon as a clear solution has formed. It is recommended, however, to heat the solution to 60–100 °C for 10–15 min.

with methanol – TMCS · MN Appl. No. 213080

- Add 1 mL methanol – TMCS to about 50 mg carboxylic acid or glyceride and heat. Then evaporate in a stream of nitrogen and dissolve again for injection in, e.g., *n*-heptane.

Silylation

with BSA, BSTFA oder SILYL-991 (BSTFA + 1 % TMCS)

BSA MN Appl. No. 213091 · BSTFA MN Appl. No. 213092 SILYL-991 MN Appl. No. 213093

- Add 0.5 mL of the silylation reagent to 1–10 mg sample; if necessary, add some solvent (normally pyridine or DMF [dimethylformamide]). Heat to 60–80 °C for 20 min to increase the reaction rate. 1–2 drops of TMCS (trimethylchlorosilane) or TSIM will also speed up the reaction.

with BSA in combination with other silylation reagents · MN Appl. No. 213100

- BSA alone silylates all sterically unhindered hydroxyl groups of the steroid skeleton; addition of TMCS will enable reaction of moderately hindered OH groups (reaction time 3–6 h at 60 °C). After addition of TSIM even strongly hindered hydroxyl groups will react (reaction time 6–24 h at 60 °C).

with MSTFA, MSHFBA or MBDSTFA

MSTFA MN Appl. No. 213111 · MSHFBA MN Appl. No. 213112 · MBDSTFA MN Appl. No. 213113

- Dissolve 10–15 mg sample in 0.8 mL solvent, then add 0.2 mL of the silylation reagent. The reaction mixture can be heated to 60–70 °C for up to 1 h and can be analyzed directly. If TFA is used as a solvent, proceed as follows [20]: dissolve 1–2 mg sample in 100 µL TFA. Dropwise add 0.9 mL of the silylating reagent. After cooling the sample can be chromatographed directly.

with TSIM or SILYL-1139 (TSIM – pyridine 11:39) · TSIM MN Appl. No. 213121 · SILYL-1139 MN Appl. No. 213122

- Dissolve 10–15 mg sample in 0.8 mL solvent, then add 0.2 mL of the silylation reagent. The reaction mixture can be heated to 60–70 °C for up to 1 hour and can be analyzed directly. Recommended solvent pyridine. When using SILYL-1139, the presence of water does not interfere.

with SILYL-21 or SILYL-2110 · SILYL-21 MN Appl. No. 213131 · SILYL-2110 MN Appl. No. 213132

- Carefully add SILYL-21 or SILYL-2110 to 1–10 mg of the sample. Precipitated ammonium chloride does not interfere. If the sample should not dissolve within 5 min, heat to 75–85 °C. If no mutarotation is to be expected, you may dissolve the sugar in warm pyridine first and then add the silylation reagent. In some cases it may be advantageous to use a different solvent instead of pyridine. For derivatization of 3-ketosteroids we recommend to use DMF (dimethylformamide)

O-trimethylsilylation with MSTFA followed by *N*-trifluoroacetylation with MBTFA · MN Appl. No. 213140

- Completely silylate 2 mg of the sample with 0.3 mL MSTFA, e.g., as described on page 368. After addition of 0.3 mL MBTFA the *N*-trimethylsilyl group is replaced by the *N*-trifluoroacetyl group. The mixture can be analyzed directly.



Test mixtures for GC capillary columns



Test mixtures

★ Key features

- Test mixtures for GC capillary columns to control the performance of fused silica capillary columns and the GC system

Test mixtures*

Designation		Pack of	REF
Activity test mixture (FA-TMS test according to Donike) in MSTFA/ <i>n</i> -hexane (1 + 4)	1 mg/mL each of TMS capric acid (C10), TMS myristic acid (C14), TMS stearic acid (C18), TMS behenic acid (C22), hexadecane (C16), eicosane (C20), tetracosane (C24), octacosane (C28)	1 mL	722307
Grob test mixture (modified) in <i>n</i> -hexane	(in mg/mL) <i>n</i> -decane (~ 2.8), <i>n</i> -undecane (~ 2.9), <i>n</i> -octanol (~ 3.6), 2,6-dimethylphenol (~ 3.2), 2,6-dimethylaniline (~ 3.2), methyl decanoate (~ 4.2), dicyclohexylamine (~ 3.1), methyl undecanoate (~ 4.2), methyl dodecanoate (~ 4.1)	1 mL	722310
MN OPTIMA® test mixture in pentane	0.1 % each of undecane, dodecane, octanol, dimethylaniline, decylamine, methyl decanoate, methyl undecanoate, heneicosane, docosane, tricosane (chromatograms see page 313)	1 mL	722316
MN OPTIMA® amine test mixture in ethanol	0.2 % diisobutylamine, 1 % diethanolamine, 0.2 % 2,6-dimethylaniline, 0.2 % <i>o</i> -propanol-pyridine, 0.2 % dicyclohexylamine, 0.2 % dibenzylamine	1 mL	722317
FAME test mixture in hexane	0.1 % each of FAMES C4, C6, C8, C10, C12, C14, C16, C18, C18:1 cis, C18:1 trans, C18:2, C18:3, C20, C22, C22:1, C24 (chromatogram see page 341)	1 mL	722320

* These products contain harmful substances which must be specially labeled as hazardous. For detailed information please see SDS.

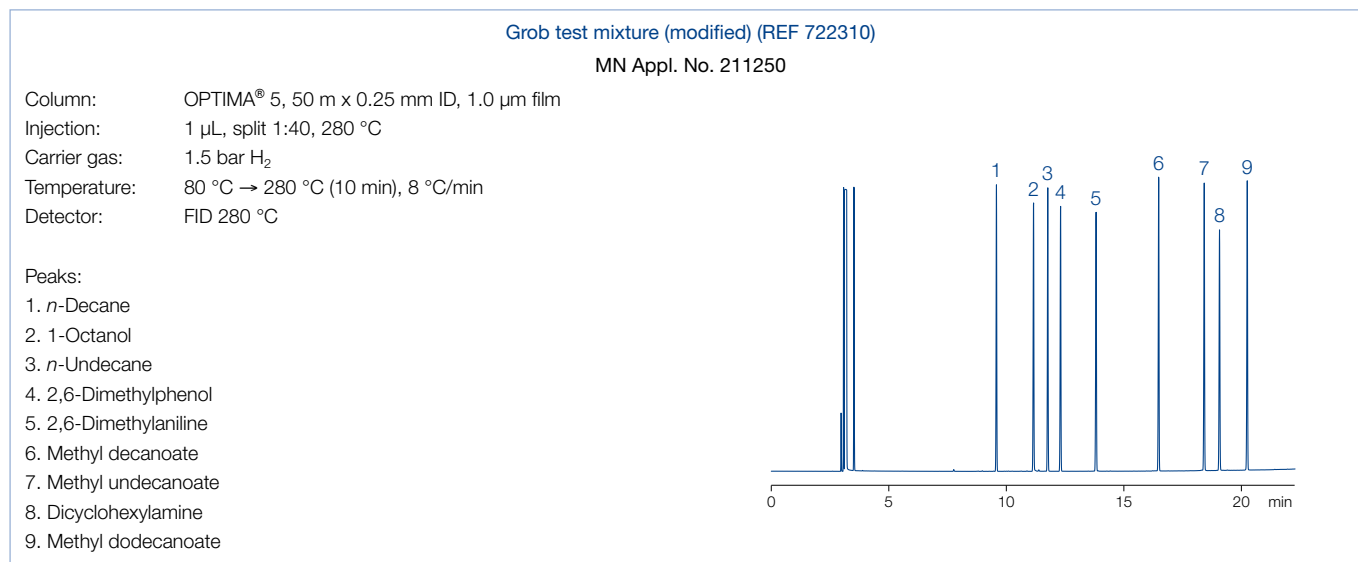

Further applications can be found online in our application database at ChromaAppDB.mn-net.com



Test mixtures for GC capillary columns

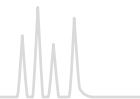

Activity test mixture (REF 722307)

MN Appl. No. 211240

Column: OPTIMA® 5, 25 m x 0.32 mm ID, 1.0 µm film
Injection: 1 µL, split 1:40, 300 °C
Carrier gas: 0.6 bar H₂
Temperature: 150 °C → 300 °C (8 min), 10 °C/min
Detector: FID 300 °C

Peaks:

1. TMS capric acid (C₁₀)
2. Hexadecane (C₁₆)
3. TMS myristic acid (C₁₄)
4. Eicosane (C₂₀)
5. TMS stearic acid (C₁₈)
6. Tetracosane (C₂₄)
7. TMS behenic acid (C₂₂)
8. Octacosane (C₂₈)

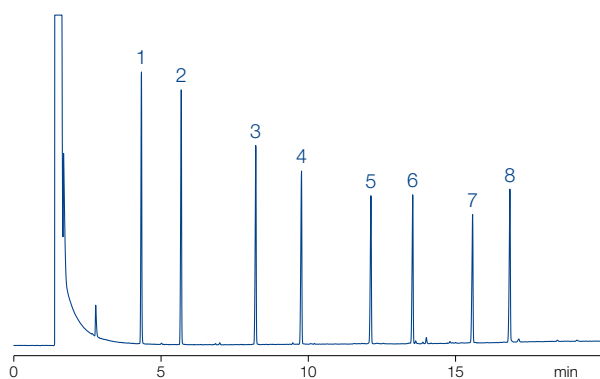

OPTIMA® Amine test mixture (REF 722317)

MN Appl. No. 250020

Column: OPTIMA® 5 Amine, 30 m x 0.32 mm ID, 1.5 µm film
Injection: 1 µL, split 1:40
Carrier gas: 0.6 bar H₂
Temperature: 100 °C → 280 °C, 10 °C/min
Detector: FID 280 °C

Peaks:

1. Diisobutylamine
2. Diethanolamine
3. 2,6-Dimethylaniline
4. o-Propanol-pyridine
5. Dicyclohexylamine
6. Dibenzylamine

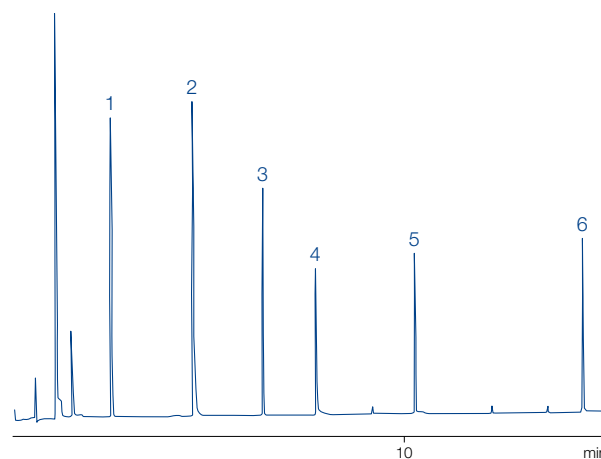

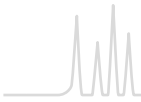

Ferrules for capillary columns



Ferrules

★ Key features

- Graphite ferrules provide the highest temperature stability (up to 450 °C). They are reusable, if handled with care. We also offer 1/16" graphite ferrules specially designed for Carlo Erba/Fisons or for Agilent gas chromatographs.
- Vespel ferrules with 40 % graphite. Temperature-stable up to 400 °C and reusable.

Ferrules

Bore (= column OD)	Graphite	Vespel +40 % Graphite
T _{max} →	450 °C	400 °C
1/16" ferrules		
0.4 mm		706246
0.5 mm	708308	
1/16" ferrules for Hewlett-Packard (Agilent) instruments		
0.4 mm	708353	
0.5 mm	708354	
0.8 mm	708355	



Septa for capillary column

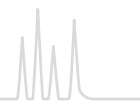

Injection Port Septa blister pack for cleanliness and easily handling

★ Key features

- BTO septa for highest demands in GC and GC-MS
 - pierced, soft – CenterGuide™
- AG3 septa with higher durability than BTO
 - pierced, hard – CenterGuide™
- Marathon Septa with extreme durability for > 400 injections
 - pierced – CenterGuide™

Injection Port Septa

Septum grade	BTO septa	AG3 septa	Marathon septa
OD	T _{max}		
9 mm	400 °C	702646	702656
11 mm	400 °C	702647	702657
11.5 mm	400 °C	702648	702658
Shimadzu®	300 °C	702649	702659
	Pack of	25	25

Standard Septa in classical plastic container

★ Key features

- Standard septa (ST) beige silicone, 60° shore A, 4 mm
- High temperature septa (HT) red non-bleeding silicone, 60° shore A, 3 mm (320 °C max.)
- Silicone septa soft, transparent
- Silicone / PTFE septa white silicone, one side coated with grey PTFE, 3 mm

Classical septa

Septum grade	Standard septa (ST)	High temperature septa (HT)	Silicone septa	Silicone septa / PTFE
OD				
9 mm	702609	702619	702602	
10 mm	702610	702620		702625
11 mm	702611	702621	702604	702626
12 mm	702612	702622	702605	702627
13 mm	702613	702623	702606	702628
17 mm		702632		
	Pack of	50	50	50

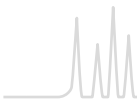

Connectors for capillary GC columns

★ Key features

- Glass connectors for fused silica capillary columns from 0.2 to 0.53 mm ID: manufactured from deactivated glass with slightly tapered inner diameter; used to join two fused silica capillaries of equal or different diameters. Advantages compared to stainless steel fittings are easy connection without tools, optical control during connection, negligible heat capacity and no dead volume.
- Graphseal ferrules for capillary columns: a stainless steel ferrule filled with graphite – the ideal sealing material for capillaries. The capillary is mounted on a 1/16" exit (detector, injector etc.), with the appropriate ferrule, a nut (with slit) and an adapter (see table below).

Connectors for capillary GC columns

Description	Pack of	REF
Graphseal ferrules for capillary columns		
0.4 mm bore	10 ferrules	708337
0.5 mm bore	10 ferrules	708318
0.8 mm bore	10 ferrules	708319
Universal capillary glass connectors		
linear	5 connectors	707971
linear	10 connectors	707972
Y splitter	1 connector	707973

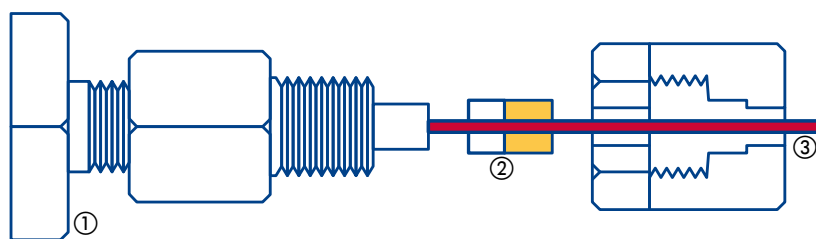

- ① 1/16" exit
- ② Graphseal ferrule
- ③ Capillary

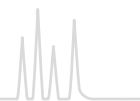

Tools and general accessories for GC

★ Key features

- Magnifying lens with scale: an essential tool for any laboratory. In capillary GC it is often important to inspect column integrity or check cut ends of capillaries. When closing a column by melting the magnifying lens can be used to check whether the column is really closed or whether an open channel has been formed in the sealed end. Our lens provides 8x magnification and is supplied with a scale as pictured in the figure below. The space between lines is equivalent to 1/10 mm.
- Diamond file: a useful tool for cutting capillaries and smoothing ends of capillaries. Square capillary ends are especially important for butt connections (e.g., in Valco unions).
- Glass wool, quartz wool and glass fiber wadding are used for, e.g., GC liners, packed GC columns etc.

Tools and general accessories

Description	Pack of	REF
Tools for capillary GC		
Diamond file for cutting capillaries and straightening capillary ends	1	708300
Magnifying lens with scale magnification 8x	1	706296
PTFE tape for sealing, reels 12 m long, 12 mm wide, 0.1 mm thick	1 reel	706512
Glass wool		
Glass wool, long fibers, DMCS treated, for packed GC columns	50 g	706201
Glass fiber wadding silanized, very fine fibers	25 g	718002
Quartz wool, very fine fibers	25 g	718587

Index of reference numbers

REF	Page
531011	303
701110.110	365
701110.201	365
701110.510	365
701120.101	365
701130.110	365
701130.510	365
701210.110	368
701210.150	368
701210.510	368
701220.110	368
701220.201	368
701220.510	368
701230.650	371
701240.510	371
701240.650	371
701260.110	369
701260.1100	369
701260.201	369
701260.510	369
701260.6100	369
701270.110	369
701270.1100	369
701270.12100	369
701270.201	369
701270.510	369
701270.6100	369
701270.650	369
701280.201	371
701280.650	371
701310.110	371
701310.201	371
701310.510	371
701410.110	365
701410.201	365
701410.510	365
701420.101	365
701420.201	365
701430.110	366
701430.201	366
701440.101	369
701440.201	369
701450.110	371
701450.201	371
701450.510	371
701460.201	371
701470.201	371
701480.201	371
701490.1100	368, 371
701490.150	368, 371
701490.201	368, 371
701520.101	366
701520.110	366
701520.201	366
701520.510	366
701950	362
701951	362
701952	362

REF	Page
701953	362
702001	116
702004	107, 125
702005	107, 114
702006	110
702007	110
702008	110
702009	110
702010	110
702011	113
702012	113
702013	113
702014	116
702015	116
702016	116
702019	128
70201CG	114
70201HP	115
70201HP.2	115
70202.1	129
702020	132
702021	137
702022	137
702023	137
702024	137
702025	106
702026	110
702027	110
702028	110
702029	111, 121
70203	123
702030	111
702031	111
702032	111, 125
702033	111, 125
702034	111, 125
702035	112
702036	111
702037	111
702038	111
702039	111
70204.36	132
702040	111
702041	112
702042	112
702043	112
702044	113
702045	113
702046	113
702047	113
702048	113
702049	113
70205.36	132
702050	124
702051	124, 126
702052	124, 126
702053	124
702055	131

REF	Page
702057	136
702058	138
702059	138
70206.36	133
702060	138
702061	138
702062	138
702063	121
702063.2080	121
702064	121
702066	108, 125
702067	108
702068	108, 125
702069	108
702070	108
702071	135
702072	131
702073	138
702074	137
702075	115
702076	115
702077	109, 113, 115, 119
702078	109, 125
702079	109, 125
70208.36	134
702080	111
702081	111
702082	111
702083	111
702084	112
702085	112
702086	133
702088	110
70209.1	134
702093	135
702094	135
702095	121
702096	126
702097	126
702098	127
702099	127
70210.36	134
702101	136
702101HP	117
702102	138
702107	111
702108	121
702109	111
702110	131
702112	135
702113	126
702114	126
702115	127
702116	127
702128	136
702129	136
70213	107, 125

REF	Page
70213.2	107, 125
702130	138
702131	137
702132	137
702133	137
702134	116, 120
702135	110
702136	131
702137	131
702138	131
702139	131
702140	131
702141	116
702142	121
702143	121
702144	136
702145	135
702147	111
702148	112
702150	123
702151	123
702155	111
702156	113
70214CG	114
70215.36	132
702158	112
702159	112
70216.36	132
702160	112
702161	112
702162	112
702163	112
702164	112
702165	112
702168	138
70217.36	133
702170	120
702171	138
702172	110
702173	116, 120
702174	116, 120
702175	117
702176	120
702177	110
702178	110
702179	110
702180	126
702181	127
702261	133
702263	133
702263.0	133
702263.2	133
702282	109, 125
702283	109, 125
702284	109, 125
702286	112
702287	111
702287.1	111

Index of reference numbers

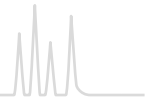

REF	Page	REF	Page	REF	Page	REF	Page
702288	111	702612	376	702799	135	702884	138
702288.1	111	702613	376	702800	106	702885	115
702292	124	702619	376	702801	117	702886	138
702293	109, 125	702620	376	702802	123	702887	117
702295	121	702621	376	702803	123	702888	116
70231	116	702622	376	702804	135	70289	106
70231.1	116	702623	376	702805	136	702891	116
70231.2	116	702625	376	702807	129	702892	115
70231.3	116	702626	376	702808	135	702893	107, 125
702311	126	702627	376	702809	116, 120	702894	138
70232	123	702628	376	702813	109, 113, 115, 119	702895	117
70233	136	702632	376	702818	109, 113, 115, 119	702904	136
702334	116, 120	702646	376	702818.1	109, 113, 115, 119	702917	132
702335	110	702647	376	702819	109, 115, 115, 121	702918	132
70234	135	702648	376	70282	106	702924	132
70234.8	135	702649	376	702823	116	702925	124
70234.9	135	702656	376	702824	107, 114	702926	124
70234.10	135	702657	376	702825	109, 113, 115, 119	702927	135
702340	135	702658	376	702826	130	702928	135
702341	135	702659	376	702826.0	130	702928.9	135
70235	136	70266	136	702826.2	130	702929	135
70236.1	136	702660	376	702827	131	702931.1	136
70239	116	702661	376	702829	135	702962	124, 126
70240	136	702662	376	702831	138	702963	124
702401	116, 121	702663	376	702833	135	702966	124
702402	113	70267	136	702834	135	702968	107, 114
702403	123	70269	136	702835	135	702968.1	107, 114
702405	113	702709	120	702837	135	702972	124
70242	136	70271	128	702838	135	702973	124, 126
702437	108	702710	121	702839	136	702974	124
70245	108	702710.1	121	70284	117	702974	124
70248	108	702710.2080	121	70285	126	702981	131
702481	108	702712	119	702857	112	702995	117
70249	108	702713	119	702858	112	702995.1	117
70250	108	702714	119	702859	117	702995.2	117
702500	109	702716	109, 113, 115, 119	70286	106	702995.3	117
702502	122, 139	702717.2	121	702860	107	702D20TB	136
702503	130, 139, 142	702717.2080	121	702863	112	706201	378
702504	123, 139	702718	121	702864	112	706246	375
702514	122, 139	702718.1	121	702865	138	706290	262
702515	123, 139	702718.2080	121	702866	130	706296	378
702516	130, 133, 139	70272	128	702866.2	130	706512	378
702517	137, 139	70273	128	702867	117	707971	377
702518	139, 142	702730	116	702872	138	707972	377
70254	133	702730.1	116	702873	112	707973	377
702540	133	702730.2	116	702874	112	708300	378
70256	116	702730.3	116	702877	138	708308	375
70257	123	702731	121	702878	106	708318	377
70260	124	702732	111	702879	116	708319	377
702602	376	70274	128	70288	116	708337	377
702604	376	70275	128	70288.1	116	708353	375
702605	376	70277	136	70288.2	116	708354	375
702606	376	702773	135	70288.3	116	708355	375
702609	376	702775	135	702882	117	711001.1000	267
70261	108	70278	136			711002.1000	267
702610	376	702780	136			711003.1000	267
702611	376	702791	138			711004.100	267
						711004.1000	267
						711005.100	267

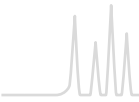

Index of reference numbers

REF	Page	REF	Page	REF	Page	REF	Page
711005.1000	267	711240.1000	267	711680.10	265	718976	261
711006.100	267	711250.1000	267	711680.100	265	718977	261
711006.1000	267	711260.1000	267	711690.100	266	718978	261
711007.100	266	711270.1000	267	711690.1000	266	719402	257
711007.1000	266	711280.10	265	711700.100	266	719403	257
711008.100	266	711280.100	265	711700.1000	266	719404	257
711008.1000	266	711300.10	265	711710.10	265	719405	257
711009.100	266	711300.100	265	711710.100	265	719406	257
711009.1000	266	711310.10	265	711720.100	266	719409	257
711010.10	265	711310.100	265	711720.1000	266	719410	257
711010.100	265	711320.10	265	711730.100	266	719411	257
711011.100	266	711320.100	265	711730.1000	266	719412	257
711011.1000	266	711330.10	265	711890.10	265	719413	257
711012.100	266	711330.100	265	711890.100	265	719414	257
711012.1000	266	711340.10	265	711991.10	265	719418	257
711013.100	266	711340.100	265	711991.100	265	719454	252
711013.1000	266	711350.10	265	711992.10	265	719455	252
711014.100	266	711350.100	265	711992.100	265	719456	252
711014.1000	266	711360.10	265	713550.0100	264	719459	252
711015.100	266	711360.100	265	713551.0100	264	719460	252
711015.1000	266	711370.10	265	713600.0100	264	719469	247
711016.100	266	711370.100	265	713601.0100	264	719475	247
711016.1000	266	711380.10	265	713610.0100	264	719489	262
711017.100	266	711380.100	265	713611.0100	264	719501	256
711017.1000	266	711390.10	265	713615.0100	264	719520	252
711018.100	266	711390.100	265	713618.0100	264	719530	256
711018.1000	266	711420.10	265	713620.0100	264	719531	256
711019.100	266	711420.100	265	713621.0100	264	719532	256
711019.1000	266	711430.10	265	713630.0100	264	719534	256
711020.10	265	711430.100	265	713631.0100	264	719535	256
711020.100	265	711470.100	266	713831.0100	264	719536	256
711021.100	266	711470.1000	266	713832.0100	264	719537	256
711021.1000	266	711480.100	266	718002	83, 378	719538	258
711022.100	266	711480.1000	266	718582	262	719539	258
711022.1000	266	711490.100	266	718583	262	719540	247
711023.100	266	711490.1000	266	718584	262	719542	252
711023.1000	266	711500.100	266	718587	378	719570	255
711024.100	266	711500.1000	266	718637	262	719571	255
711024.1000	266	711510.10	265	718755	263	719574	255
711025.100	266	711510.100	265	718760	263	719575	255
711025.1000	266	711520.10	265	718761	263	719600	247
711026.100	266	711520.100	265	718762	263	720001.40	223
711026.1000	266	711530.10	265	718763	263	720001.46	223
711027.100	266	711530.100	265	718765	263	720002.20	220
711027.1000	266	711540.1000	267	718766	263	720002.30	220
711028.100	266	711550.1000	267	718767	263	720002.40	220
711028.1000	266	711560.10	265	718768	263	720002.46	220
711029.100	266	711560.100	265	718769	263	720013.40	223
711029.1000	266	711570.10	265	718770	263	720013.46	223
711031.100	266	711570.100	265	718771	263	720014.20	220
711031.1000	266	711580.10	265	718772	263	720014.30	220
711032.100	266	711580.100	265	718775	263	720014.40	220
711032.1000	266	711590.100	266	718966	259	720014.46	220
711033.1000	267	711590.1000	266	718967	259	720017.46	223
711034.1000	267	711600.10	265	718968	259	720018.40	221
711035.100	267	711600.100	265	718969	259	720018.46	221
711035.1000	267	711610.1000	267	718970	259	720019.40	226
711036.1000	267	711620.1000	267	718971	259	720019.46	226
711037.1000	267	711630.1000	267	718975	261	720022.40	223

Index of reference numbers

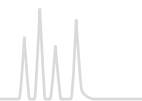

REF	Page	REF	Page	REF	Page	REF	Page
720022.46	223	720133.40	220	720935.40	221	721924.30	251
720023.40	221	720133.46	220	720935.46	221	722307	373
720023.46	221	720140.46	221	720936.40	221	722310	373
720024.40	228	720141.40	220	720936.46	221	722316	373
720024.46	228	720141.46	220	720949.46	220	722317	373
720025.46	227	720143.46	226	720951.46	221	722320	373
720028.46	229	720149.40	221	720956.46	226	722393	236
720029.46	229	720149.46	221	720989.46	229	723060.10	342
720040.40	221	720150.40	220	720990.46	223	723060.25	342
720040.46	221	720150.46	220	720994.46	227	723060.30	342
720041.40	221	720165.46	223	720996.40	229	723060.50	342
720041.46	221	720170.40	222	720996.46	229	723060.60	342
720042.40	221	720170.46	222	721020.30	227	723063.25	359
720043.40	221	720174.46	222	721022.30	220	723064.10	342, 346
720043.46	221	720175.40	222	721024.30	229	723101.10	360
720046.40	241	720175.46	222	721025.30	229	723101.25	360
720050.40	223	720182.46	229	721030.30	225	723105.10	360
720050.46	223	720183.46	229	721039.30	228	723105.25	360
720051.40	221	720191.40	221	721061.30	223	723106.10	360
720051.46	221	720191.46	221	721070.30	221	723106.25	360
720052.40	223	720193.46	221	721071.30	224	723108.10	360
720052.46	223	720194.46	224	721072.30	221	723108.25	360
720055.40	221	720196.40	224	721073.30	221	723116.10	343
720055.46	221	720196.46	224	721074.20	220	723116.25	343
720057.40	228	720205.40	228	721074.30	220	723116.30	343
720057.46	228	720205.46	228	721075.30	221	723116.50	343
720059.40	225	720214.46	223	721078.30	228	723116.60	343
720059.46	225	720231.40	250	721083.30	225	723148.10	360
720062.46	223	720245.40	250	721085.30	222	723148.25	360
720065.40	222	720252.40	251	721093.30	223	723151.10	360
720065.46	222	720258.40	251	721095.30	223	723151.25	360
720071.40	223	720280.40	221	721096.30	223	723180.10	343, 346
720071.46	223	720280.46	221	721119.30	250	723180.20	343, 346
720074.46	222	720294.46	221	721133.30	221	723181.10	343, 346
720077.46	222	720296.40	221	721137.30	226	723296.10	342
720081.40	242	720296.46	221	721142.30	226	723296.25	342
720088.40	243	720305.46	221	721155.30	227	723296.30	342
720089.46	225	720350.40	243	721157.30	222	723296.50	342
720090.40	228	720430.40	221	721158.30	227	723296.60	342
720090.46	228	720430.46	221	721167.30	230	723321.10	342
720093.46	230	720431.40	221	721168.20	236	723321.25	342
720094.40	237	720431.46	221	721168.30	236	723321.30	342
720095.46	227	720432.46	221	721169.30	237	723321.50	342
720095.46RP	227	720445.46	240	721170.30	254	723321.60	342
720096.46	225	720450.46	240	721171.30	239	723327.25	359
720097.40	229	720451.46	240	721176.30	239	723341.25	343
720097.46	229	720471.46	221	721178.30	239	723341.30	343
720098.46	220	720472.40	221	721185.30	240	723341.50	343
720099.46	230	720472.46	221	721186.30	240	723341.60	343
720110.46	221	720701.46	221	721188.30	242	723344.10	343
720117.20	236	720709.46	229	721190.30	243	723344.25	343
720117.30	236	720730.46	221	721194.30	223	723344.30	343
720117.40	236	720735.46	223	721196.30	221	723344.50	343
720117.46	236	720740.46	221	721402.30	241	723344.60	343
720120.40	220	720752.40	239	721469.30	239	723346.10	360
720120.46	220	720841.46	220	721473.30	220	723346.25	360
720124.40	239	720905.40	254	721518.30	230	723348.10	360
720125.40	239	720923.30	236	721649.30	221	723348.25	360
720127.40	239	720923.40	236	721916.30	225	723349.10	360

Index of reference numbers

REF	Page
723349.25	360
723356.25	343
723356.50	343
723358.25	350
723358.50	350
723360.25	347
723360.50	347
723362.25	347
723362.50	347
723364.25	347
723364.50	347
723366.25	347
723366.50	347
723368.25	347
723368.50	347
723370.25	350
723370.50	350
723379.25	347
723379.50	347
723381.25	350
723381.50	350
723382.10	346, 347
723383.10	346, 350
723384.25	350
723384.50	350
723386.25	350
723387.25	350
723387.50	350
723388.25	350
723388.50	350
723409.50	359
723411.25	359
723501.10	360
723501.25	360
723515.10	342
723515.25	342
723517.10	342
723517.25	342
723517.30	342
723549.10	342
723549.25	342
723549.30	342
723555.10	343
723555.25	343
723555.50	343
723558.10	360
723558.25	360
723560.10	360
723560.25	360
723562.10	360
723562.25	360
723706.10	361
723706.25	361
723707.10	361
723707.25	361
723708.10	361
723708.25	361
723709.10	361
723709.25	361

REF	Page
723710.10	361
723710.25	361
723711.10	361
723711.25	361
723712.10	361
723712.25	361
723713.10	361
723713.25	361
723714.10	361
723714.25	361
723790.1	360
723790.2	360
723791.1	360
723791.2	360
723792.1	360
723792.2	360
723793.1	360
723793.2	360
723827.10	342
723827.25	342
723827.50	342
723830.10	343
723830.25	343
723830.50	343
723890.100	357
723936.25	343
723936.50	343
723945.25	358
723945.50	358
725801.25	321
725801.50	321
725802.30	321
725802.60	321
725805.15	321
725805.30	321
725805.60	321, 323
725806.30	321
725806.60	321
725807.30	321
725807.60	321
725810.25	324
725810.50	324
725811.30	324
725811.60	324
725812.25	324
725812.60	324
725813.30	324
725815.12	324
725815.50	324
725820.15	324
725820.30	324
725820.60	324
725825.30	324
725825.60	324
725826.30	324
725826.60	324
725850.30	325
725850.60	325
726022.15	335

REF	Page
726022.25	335
726022.30	335
726022.50	335
726022.60	335
726024.10	318, 346
726024.20	318, 346
726025.20	318, 346
726038.10	318
726038.15	318
726038.25	318
726038.30	318
726038.60	318
726050.10	318
726050.15	318
726050.25	318
726050.30	318
726050.50	318
726050.60	318
726056.10	322
726056.15	322
726056.25	322
726056.30	322
726056.50	322
726056.60	322
726058.10	332
726058.15	332
726058.25	332
726058.30	332
726058.50	332
726058.60	332
726064.30	332
726064.60	332
726065.12	335
726065.25	335
726065.50	335
726066.25	335
726066.50	335
726067.25	335
726067.30	335
726067.50	335
726067.60	335
726080.10	346, 349
726081.10	318
726081.25	318
726081.30	318
726081.50	318
726081.60	318
726089.30	339
726089.50	339
726089.60	339
726090.30	339
726090.60	339
726091.25	339
726091.30	339
726091.50	339
726091.60	339
726095.30	339
726095.60	339
726096.30	339

REF	Page
726096.60	339
726099.25	322
726099.30	322
726099.50	322
726099.60	322
726102.15	354
726102.30	354
726104.15	354
726104.30	354
726106.15	354
726106.30	354
726108.15	354
726108.30	354
726116.25	341
726116.30	341
726116.50	341
726116.60	341
726118.15	338
726118.25	338
726118.30	338
726118.50	338
726118.60	338
726131.10	353
726131.25	353
726132.10	353
726132.25	353
726133.10	353
726133.25	353
726154.30	334
726154.60	334
726157.30	334
726157.60	334
726162.30	336
726162.60	336
726165.30	336
726165.60	336
726180.10	341, 346
726201.25	320
726201.50	320
726202.30	320
726202.60	320
726203.12	320
726205.15	320
726205.30	320
726205.60	320
726210.12	323
726210.25	323
726210.50	323
726211.30	323
726212.25	323
726212.50	323
726212.60	323
726213.30	323
726215.12	323
726215.25	323
726215.50	323
726220.15	323
726220.30	323
726220.60	323

Index of reference numbers

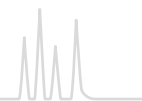

REF	Page	REF	Page	REF	Page	REF	Page
726225.30	323	726325.15	322	726519.30	318	726735.50	332
726225.60	323	726325.25	322	726521.10	318	726742.25	335
726226.30	323	726325.30	322	726521.25	318	726742.30	335
726226.60	323	726325.50	322	726521.30	318	726742.50	335
726296.25	340	726325.60	322	726521.50	318	726742.60	335
726296.30	340	726341.25	341	726523.10	322	726744.25	335
726296.50	340	726341.30	341	726523.25	322	726744.30	335
726296.60	340	726341.50	341	726523.30	322	726744.50	335
726301.10	318	726341.60	341	726525.10	322	726744.60	335
726301.25	318	726344.25	341	726525.25	322	726747.10	335
726301.30	318	726344.30	341	726525.30	322	726747.15	335
726301.50	318	726344.50	341	726525.50	322	726747.25	335
726301.60	318	726345.30	341	726525.60	322	726747.30	335
726302.10	318	726346.25	341	726529.10	318	726755.30	335
726302.15	318	726351.25	335	726529.15	318	726757.25	335
726302.25	318	726351.30	335	726529.25	318	726757.30	335
726302.30	318	726351.50	335	726529.30	318	726757.50	335
726302.50	318	726351.60	335	726541.10	322	726757.60	335
726302.60	318	726352.25	338	726541.15	322	726771.25	329
726304.10	318	726352.30	338	726541.25	322	726771.30	329
726304.25	318	726352.50	338	726541.30	322	726771.50	329
726304.30	318	726352.60	338	726545.10	332	726771.60	329
726304.50	318	726353.30	355	726545.15	332	726777.25	329
726304.60	318	726354.30	355	726545.25	332	726777.30	329
726313.10	322	726355.25	355	726545.30	332	726777.60	329
726313.15	322	726356.30	355	726548.30	340	726780.30	329
726313.25	322	726357.30	355	726549.25	340	726780.50	329
726313.30	322	726358.30	355	726549.30	340	726780.60	329
726313.50	322	726359.30	355	726600.25	340	726783.25	329
726313.60	322	726360.30	355	726600.30	340	726784.25	331
726314.15	322	726361.10	346, 355	726600.50	340	726785.25	331
726314.25	322	726400.25	327	726600.60	340	726785.30	331
726314.30	322	726400.50	327	726623.25	322	726785.50	331
726314.50	322	726410.10	327, 346	726623.30	322	726785.60	331
726314.60	322	726410.20	327, 346	726623.50	322	726786.30	331
726316.25	322	726420.30	327	726623.60	322	726786.50	331
726316.30	322	726420.60	327	726628.25	322	726787.25	331
726316.50	322	726421.30	327	726628.30	322	726787.30	331
726316.60	322	726440.30	327	726628.50	322	726787.50	331
726318.10	332	726440.60	327	726628.60	322	726787.60	331
726318.15	332	726441.30	327	726630.30	333	726789.25	331
726318.25	332	726441.60	327	726630.60	333	726789.30	331
726318.30	332	726442.30	327	726631.30	333	726802.25	318
726318.50	332	726442.60	327	726631.60	333	726802.30	318
726318.60	332	726443.30	327	726633.30	333	726802.50	318
726320.25	332	726465.25	328	726633.60	333	726802.60	318
726320.30	332	726465.50	328	726634.30	333	726805.25	318
726320.50	332	726470.30	328	726634.60	333	726805.30	318
726320.60	332	726470.60	328	726640.30	330	726805.50	318
726321.25	340	726480.30	328	726640.60	330	726805.60	318
726321.30	340	726480.60	328	726641.30	330	726807.25	322
726321.50	340	726481.30	328	726641.60	330	726807.30	322
726321.60	340	726481.60	328	726642.30	330	726807.50	322
726323.10	318	726482.30	328	726642.60	330	726807.60	322
726323.15	318	726482.60	328	726643.30	330	726809.25	322
726323.25	318	726483.30	328	726643.60	330	726809.30	322
726323.30	318	726490.10	328, 346	726735.15	332	726809.50	322
726323.50	318	726519.15	318	726735.25	332	726809.60	322
726323.60	318	726519.25	318	726735.30	332	726821.25	318

Index of reference numbers

REF	Page
726821.30	318
726821.50	318
726821.60	318
726824.25	332
726824.30	332
726824.50	332
726824.60	332
726832.25	318
726834.12	318
726834.25	318
726834.50	318
726837.12	318
726837.25	318
726837.50	318
726839.50	318
726841.25	332
726841.50	332
726846.10	322, 346
726848.10	346, 349
726854.25	322
726857.25	322
726857.50	322
726860.25	322
726860.50	322
726863.25	322
726863.50	322
726871.15	337
726871.25	337
726871.30	337
726871.50	337
726871.60	337
726874.30	337
726874.50	337
726874.60	337
726877.15	337
726877.30	337
726877.50	337
726877.60	337
726880.25	337
726880.30	337
726880.50	337
726880.60	337
726900.30	352
726903.10	352
726905.30	352
726911.25	322
726911.30	322
726911.50	322
726911.60	322
726916.10	322
726916.25	322
726916.30	322
726916.50	322
726926.10	318
726926.25	318
726926.30	318
726926.50	318
726929.25	332
726929.30	332

REF	Page
726929.50	332
726929.60	332
726931.10	318
726931.25	318
726931.30	318
726931.50	318
726934.15	322
726934.25	322
726934.30	322
726934.50	322
726965.30	332
727401	83
727407	83
727420	83
727421	83
727422	83
727423	83
727424	83
727450	83
727451	83
728777.20	259
728777.30	259
728778.20	259
728778.30	259
729004	93
729004.400	93
729006	93
729007	92
729007.400	92
729008	92
729008.800	92
729009	92
729009.800	92
729010	94
729011	94
729012	94
729012.400	94
729013	94
729013.400	94
729014	92
729015	92
729020	91
729020.400	91
729021	91
729021.400	91
729022	91
729022.800	91
729023	91
729023.800	91
729024	93
729025	93
729026	93
729026.400	93
729027	93
729027.400	93
729028	95
729028.400	95
729030	91
729030.400	91

REF	Page
729031	91
729031.400	91
729032	90
729032.400	90
729033	90
729033.400	90
729034	95
729036	91
729036.800	91
729037	91
729037.800	91
729039	90
729039.400	90
729043	95
729044	95
729048	94
729048.800	94
729049	94
729049.800	94
729050	90
729050.400	90
729051	90
729051.400	90
729100	96
729101	96
729102	96
729204	93
729204.400	93
729205	92
729205.400	92
729206	93
729207	92
729207.400	92
729208	92
729209	92
729212	94
729212.400	94
729213	94
729213.400	94
729218	95
729218.400	95
729219	95
729219.400	95
729220	91
729220.400	91
729221	91
729221.400	91
729222	91
729223	91
729226	93
729226.400	93
729227	93
729227.400	93
729228	95
729228.400	95
729229	91
729229.400	91
729230	91
729230.400	91

REF	Page
729231	91
729231.400	91
729234	95
729236	91
729237	91
729240	94
729240.400	94
729241	94
729241.400	94
729242	94
729243	95
729244	95
729245	92
729245.400	92
729246	92
729246.400	92
729247	92
729248	94
729249	94
729254	93
729255	93
729256	92
729257	92
729258	96
730001	34
730002	34
730003	34
730003.250	34
730004	34
730004.250	34
730005	34
730005.250	34
730007	43
730008	34
730009	34
730010	33
730011	33
730011ASP	69
730011MPS	69
730012	33
730012G	33
730012MPS	69
730013	33
730013.250	33
730013ASP	69
730013MPS	69
730014	33
730014.250	33
730014G	33
730015	33
730015.250	33
730015G	33
730016	33
730017	42
730020	42
730021	36
730022	36
730023	36
730024	36

Index of reference numbers

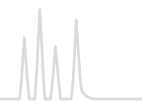

REF	Page	REF	Page	REF	Page	REF	Page
730026	68	730135G	51	730238	43	730506	65
730028	34	730139	42	730238G	43	730507	65
730031	39	730139G	42	730239	43	730507.100	65
730033	39	730141	33	730239G	43	730508	65
730033G	39	730149	53	730243	67	730509	65
730034	68	730149.250	53	730249	52	730517.3100	98
730049	25	730149G	53	730249G	52	730517.6100	98
730049P45	25	730150N	68	730249G.250	52	730533	61
730053	40	730151N	68	730250	42	730564N	69
730061	40	730152	67	730259	33	730566	68
730063	40	730153N	69	730261	34	730570.320	98
730070	38	730154N	69	730269	33	730570.345	98
730070G	38	730155	62	730275	44	730570.620	98
730071	38	730156	61	730283	49	730570.645	98
730072	38	730157N	69	730283.250	49	730578.620	98
730073	38	730158	68	730296	35	730578.645	98
730073.250	38	730159	68	730297	35	730586	65
730073G	38	730160	68	730299	35	730590N	69
730073MPS	69	730161	68	730300	35	730593	41
730075	38	730162	68	730301	35	730594	41
730075.250	38	730163	68	730310	32	730595.500	65
730075G	38	730164	68	730322	45	730595.1000	65
730076	44	730165	61	730323	45	730595.5000	65
730077	44	730166	50	730351	68	730595.50000	65
730077.250	44	730166G	50	730355	68	730601	36
730078	45	730167	61	730356	68	730602	34
730079	45	730168	47	730358.2	62	730603	39
730081	43	730168.250	47	730376	32	730605	40
730082	43	730171	68	730377	32	730606	37
730082.250	43	730172	68	730378	32	730607	40
730082G	43	730173N	68	730380	68	730608	38
730084	37	730174N	68	730382	68	730609	44
730085	55	730175N	68	730385	68	730610	45
730085.250	55	730176N	68	730386	67	730611	33
730101	68	730177N	68	730387	67	730612	34
730103	68	730178N	68	730389	68	730613	33
730105	68	730179N	67	730394	32	730616	50
730106	69	730180	39	730400	34	730618	51
730107	38	730180G	39	730402	34	730619	53
730107.250	38	730183.12	67	730403	34	730620	51
730107G	38	730184.12	67	730404	33	730622	43
730108	31	730185N	67	730405	33	730626	39
730108.250	31	730187N	69	730406	38	730626G	39
730109	53	730188N	69	730418	40	730628	35
730111	31	730189.1	69	730425	44	730629	46
730111.AOX	50	730189.12	69	730426	45	730630	46
730111G	31	730191	68	730436.100	61	730640	42
730117	31	730192	68	730446	42	730641	42
730118	31	730193N	69	730453	42	730642	42
730119	31	730194	67	730457	43	730643	41
730119.AOX	50	730212	44	730462	46	730646.2	62
730125	55	730214	38	730474	68	730648	61
730126	43	730214G	38	730475	68	730648.1	61
730127	43	730217	38	730483	46	730648.3	61
730130	34	730221	37	730487	65	730648.3T	61
730132	54	730225	38	730487.250	65	730650.100	62
730132.250	54	730227	38	730489	65	730651	38
730135	51	730230	68	730502	65	730652	37
730135.250	51	730233N	69	730505	65	730653	58

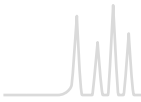

Index of reference numbers

REF	Page	REF	Page	REF	Page	REF	Page
730653.20	58	730850.2	62	730970	61	731860	32
730657	60	730858.2	62	730970.1	61	731861	32
730657.2	62	730921	22	730970.3	61	731862	32
730658	60	730921P30	22	730970.3T	61	731863	32
730660	43	730922	22	730970.100	61	731865	32
730670.2	62	730922P30	22	730971	61	731866	32
730680	48	730923	22	730971.3	61	731867	32
730681	47	730923.250	22	730971.3T	61	731868	32
730690	32	730923P30	22	730972	62	731870	32
730694.1	61	730924	22	730972.100	62	731871	32
730712	63	730924.250	22	730973	62	731875	32
730714	63	730924P30	22	730974	62	731877	32
730716	63	730925	22	730974.100	62	731909	32
730718	63	730926	22	730975	62	731921	22
730720	63	730926.250	22	730975.100	62	731922	22
730722	63	730927	22	730980	62	731923	22
730724	63	730927.250	22	730983.2	62	732012	33
730727	28	730928	22	730984	61	732013	33
730727P45	28	730929	22	730987.2	62	732020	68
730728	28	730931	24	730989.3	61	732108	31
730728P45	28	730931.250	24	730989.3T	61	732132	24
730729	28	730931MPS	69	730992	62	732140	22
730729P45	28	730931P45	24	730996.2	62	732141	22
730731	27	730934	24	731741	38	732460	81
730731P45	27	730934P45	24	731744	24	732461	81
730732	63	730935	24	731745	24	732462	81
730733	27	730935MPS	69	731755	25	732463	81
730733P45	27	730935P45	24	731756	25	732464	81
730734	63	730936	24	731757	25	732465	81
730735	27	730936P45	24	731768	26	732466	81
730735P45	27	730937	24	731769	26	732467	81
730736	63	730938	24	731770	26	732501	68
730737	27	730938.250	24	731771	28	732700	80
730738	63	730939	24	731772	28	732701	80
730739	27	730939.250	24	731773	28	732702	80
730739P45	27	730939MPS	69	731774	27	732703	80
730740	63	730940	24	731775	27	732704	80
730741	27	730941	24	731776	27	732705	80
730742	63	730944	22	731801	34	732706	80
730743	27	730944P30	22	731802	34	732707	80
730744	28	730950	26	731803	34	732708	80
730745	28	730950P45	26	731804	33	732709	80
730747	28	730951	26	731805	33	732711	81
730747P45	28	730951P45	26	731806	33	732712	81
730748	28	730952	25	731830	38	732713	81
730748P45	28	730952P45	25	731831	44	732714	81
730749	28	730953	25	731832	44	732715	81
730751	30	730954	26	731833	44	732716	81
730753	30	730955	25	731835	45	732717	81
730754	30	730956	25	731836	45	732718	81
730754.250	30	730956P45	25	731840	31	732719	81
730755	30	730957	25	731841	31	732720	80
730755.250	30	730958	26	731844	42	732760	81
730756	30	730964	61	731845	42	732761	81
730757	30	730966	26	731848	43	732762	81
730759	30	730968	26	731849	43	732763	81
730798	82	730968P45	26	731852	62	732764	81
730842	62	730969	25	731853	62	732765	81
730843.2	62	730969P45	25	731854	62	732766	81

Index of reference numbers

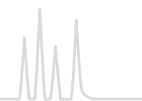

REF	Page	REF	Page	REF	Page	REF	Page
732767	81	735133	140,123	738656.M	98	760059.30	183
732800	80	735208	106, 140	738657.M	98	760059.40	183
732801	80	735211	118, 140	738658.M	98	760059.46	183
732802	80	735220	134, 140	738659.M	98	760060.20	183
732803	80	735311	118, 140	738660.M	98	760060.30	183
732804	80	735320	134, 140	738661.M	98	760060.40	183
732805	80	735408	106, 140	738663.M	98	760060.46	183
732806	80	735500	118, 134, 141	738770.M	98	760061.46	183
732807	80			738771.M	98	760062.20	183
732808	80	735501	118, 134, 141	738920.060M	22	760062.30	183
732809	80			738921.010M	22	760062.40	183
732810	80	735509	134, 137, 141	738921.030M	22	760062.46	183
732811	80			760001.20	183	760063.20	183
732812	80	735511	118, 141	760001.30	183	760063.30	183
732813	80	735513	141,123	760001.40	183	760063.40	183
732814	80	735520	134, 141	760001.46	183	760063.46	183
732815	80	735532	134, 141	760002.20	183	760064.46	183
732816	80	735533	141,123	760002.30	183	760071.20	160
732817	80	735611	118, 141	760002.40	183	760075.20	160
732818	80	735613	141,123	760002.46	183	760076.20	160
732819	80	735620	134, 141	760004.20	183	760076.30	160
732850	80	735700	118, 134, 141,123	760004.30	183	760076.40	160
732903	82			760004.40	183	760076.46	160
732960	80	735711	118, 141	760004.46	183	760078.20	160
732961	80	735713	141,123	760007.40	190	760078.30	160
732962	80	735720	134, 141	760007.46	190	760078.40	160
732963	80	735732	134, 141	760008.20	183	760078.46	160
732964	80	735733	141,123	760008.30	183	760079.20	160
732965	80	735811	118, 141	760008.40	183	760079.30	160
732966	80	735813	141,123	760008.46	183	760079.40	160
732967	80	735820	134, 141	760012.46	190	760079.46	160
732980	80	735911	118, 140	760013.20	183	760080.20	160
732980FE	80	735913	140,123	760013.30	183	760080.30	160
732981	80	735920	134, 140	760013.40	183	760080.40	160
732981FE	80	736400.40	246	760013.46	183	760080.46	160
732982	80	736596.40	246	760023.46	190	760081.20	160
732982FE	80	736597.100	246	760035.46	183	760081.30	160
732983	80	736598	246	760046.46	182	760081.40	160
732983FE	80	736599.100	246	760050.20	182	760081.46	160
732984	80	736601	246	760050.30	182	760082.20	160
732984FE	80	736602.100	246	760050.40	182	760082.30	160
732985	80	738001.100M	34	760050.46	182	760082.40	160
732985FE	80	738011.050M	33	760051.20	182	760082.46	160
732986	80	738071.100M	38	760051.30	182	760083.20	160
732986FE	80	738101.100M	45	760051.40	182	760083.30	160
732987	80	738131.150M	65	760051.46	182	760083.40	160
732987FE	80	738520.050M	30	760052.20	182	760083.46	160
733110.25	356	738530.010M	24	760052.30	182	760084.20	160
733110.50	356	738530.025M	24	760052.40	182	760084.30	160
733111.10	346, 356	738530.050M	24	760052.46	182	760084.40	160
733299.25	356	738630.M	71, 98	760053.20	182	760084.46	160
733299.50	356	738637	71	760053.30	182	760086.46	160
733442.50	356	738638	71	760053.40	182	760100.20	161
733551.25	356	738639.M	71	760053.46	182	760100.30	161
735111	118, 140	738645	71	760054.20	182	760100.40	161
735113	140,123	738650.5	71	760054.30	182	760100.46	161
735120	134, 140	738651	71	760054.40	182	760101.20	161
735126	106, 140	738652	71	760054.46	182	760101.30	161
735132	134, 140	738655.2M	98	760059.20	183	760101.40	161

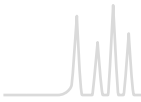

Index of reference numbers

REF	Page	REF	Page	REF	Page	REF	Page
760101.46	161	760195.40	249	760273.46	167	760396.20	165
760102.20	161	760195.46	249	760274.20	167	760397.46	165
760102.30	161	760196.20	249	760275.20	167	760400.20	165
760102.40	161	760196.30	249	760301.20	179	760400.30	165
760102.46	161	760196.40	249	760301.30	179	760400.40	165
760103.20	161	760196.46	249	760301.40	179	760400.46	165
760103.30	161	760200.20	167	760301.46	179	760401.20	165
760103.40	161	760200.30	167	760304.20	179	760401.30	165
760103.46	161	760200.40	167	760305.20	179	760401.40	165
760104.20	161	760200.46	167	760305.30	179	760401.46	165
760104.30	161	760201.20	167	760305.40	179	760402.20	165
760104.40	161	760201.30	167	760305.46	179	760402.30	165
760104.46	161	760201.40	167	760306.20	179	760402.40	165
760106.46	161	760201.46	167	760306.30	179	760402.46	165
760149.40	187	760202.20	167	760306.40	179	760403.20	165
760149.46	187	760202.30	167	760306.46	179	760403.30	165
760150.40	187	760202.40	167	760308.20	179	760403.40	165
760150.46	187	760202.46	167	760311.20	180	760403.46	165
760151.40	187	760203.20	167	760311.30	180	760404.20	165
760151.46	187	760203.30	167	760311.40	180	760404.30	165
760152.40	187	760203.40	167	760311.46	180	760404.40	165
760152.46	187	760203.46	167	760312.46	180	760404.46	165
760153.40	187	760204.20	167	760313.20	180	760405.20	165
760153.46	187	760204.30	167	760313.30	180	760405.30	165
760154.46	187	760204.40	167	760313.40	180	760405.40	165
760156.40	187	760204.46	167	760313.46	180	760405.46	165
760156.46	187	760205.46	167	760314.20	180	760406.20	165
760157.20	187	760259.46	167	760314.30	180	760406.30	165
760157.30	187	760260.20	167	760314.40	180	760406.40	165
760159.20	187	760260.30	167	760314.46	180	760406.46	165
760170.46	190	760260.40	167	760315.20	180	760407.20	165
760172.46	190	760260.46	167	760315.30	180	760407.30	165
760173.46	190	760261.20	167	760315.40	180	760407.40	165
760183.20	249	760261.30	167	760315.46	180	760407.46	165
760183.30	249	760261.40	167	760316.20	180	760409.20	165
760183.40	249	760261.46	167	760316.30	180	760410.20	165
760183.46	249	760262.20	167	760316.40	180	760410.30	165
760184.20	249	760262.30	167	760316.46	180	760410.40	165
760184.30	249	760262.40	167	760321.20	179	760410.46	165
760184.40	249	760262.46	167	760321.30	179	760412.20	165
760184.46	249	760263.20	167	760321.40	179	760412.30	165
760185.20	249	760263.30	167	760321.46	179	760412.40	165
760185.30	249	760263.40	167	760322.46	179	760412.46	165
760185.40	249	760263.46	167	760323.20	179	760413.20	165
760185.46	249	760264.20	167	760323.30	179	760413.30	165
760186.20	249	760264.30	167	760323.40	179	760413.40	165
760186.30	249	760264.40	167	760323.46	179	760413.46	165
760186.40	249	760264.46	167	760324.20	179	760414.20	165
760186.46	249	760271.20	167	760324.30	179	760414.30	165
760193.20	249	760271.30	167	760324.40	179	760414.40	165
760193.30	249	760271.40	167	760324.46	179	760414.46	165
760193.40	249	760271.46	167	760325.20	179	760415.20	165
760193.46	249	760272.20	167	760325.30	179	760415.30	165
760194.20	249	760272.30	167	760325.40	179	760415.40	165
760194.30	249	760272.40	167	760325.46	179	760415.46	165
760194.40	249	760272.46	167	760326.20	179	760416.46	165
760194.46	249	760273.20	167	760326.30	179	760431.20	175
760195.20	249	760273.30	167	760326.40	179	760431.30	175
760195.30	249	760273.40	167	760326.46	179	760431.40	175

Index of reference numbers

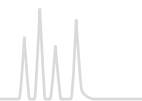

REF	Page	REF	Page	REF	Page	REF	Page
760431.46	175	760463.40	169	760530.20	185	760576.20	171
760433.20	175	760463.46	169	760530.30	185	760576.30	171
760433.30	175	760465.20	169	760530.40	185	760576.40	171
760433.40	175	760466.20	169	760530.46	185	760576.46	171
760433.46	175	760466.30	169	760531.20	185	760577.20	171
760435.20	175	760466.40	169	760531.30	185	760577.30	171
760436.20	175	760466.46	169	760531.40	185	760577.40	171
760436.30	175	760468.20	169	760531.46	185	760577.46	171
760436.40	175	760473.20	169	760532.20	185	760578.20	171
760436.46	175	760473.30	169	760532.30	185	760578.30	171
760438.20	175	760473.40	169	760532.40	185	760578.40	171
760443.20	175	760473.46	169	760532.46	185	760578.46	171
760443.30	175	760475.46	169	760533.20	185	760579.20	171
760443.40	175	760476.20	169	760533.30	185	760579.30	171
760443.46	175	760476.30	169	760533.40	185	760579.40	171
760445.46	175	760476.40	169	760533.46	185	760579.46	171
760446.20	175	760476.46	169	760534.20	185	760583.20	171
760446.30	175	760477.20	169	760534.30	185	760583.30	171
760446.40	175	760477.30	169	760534.40	185	760583.40	171
760446.46	175	760477.40	169	760534.46	185	760583.46	171
760447.20	175	760477.46	169	760550.20	185	760585.46	171
760447.30	175	760478.20	169	760550.30	185	760586.20	171
760447.40	175	760478.30	169	760550.40	185	760586.30	171
760447.46	175	760478.40	169	760550.46	185	760586.40	171
760448.20	175	760478.46	169	760551.20	185	760586.46	171
760448.30	175	760479.20	169	760551.30	185	760587.20	171
760448.40	175	760479.30	169	760551.40	185	760587.30	171
760448.46	175	760479.40	169	760551.46	185	760587.40	171
760449.20	175	760479.46	169	760552.20	185	760587.46	171
760449.30	175	760483.20	169	760552.30	185	760588.20	171
760449.40	175	760483.30	169	760552.40	185	760588.30	171
760449.46	175	760483.40	169	760552.46	185	760588.40	171
760453.20	175	760483.46	169	760553.20	185	760588.46	171
760453.30	175	760485.46	169	760553.30	185	760589.20	171
760453.40	175	760486.20	169	760553.40	185	760589.30	171
760453.46	175	760486.30	169	760553.46	185	760589.40	171
760455.46	175	760486.40	169	760554.20	185	760589.46	171
760456.20	175	760486.46	169	760554.30	185	760591.20	163
760456.30	175	760487.20	169	760554.40	185	760591.30	163
760456.40	175	760487.30	169	760554.46	185	760591.40	163
760456.46	175	760487.40	169	760561.20	171	760591.46	163
760457.20	175	760487.46	169	760561.30	171	760593.20	163
760457.30	175	760488.20	169	760561.40	171	760593.30	163
760457.40	175	760488.30	169	760561.46	171	760593.40	163
760457.46	175	760488.40	169	760563.20	171	760593.46	163
760458.20	175	760488.46	169	760563.30	171	760595.20	163
760458.30	175	760489.20	169	760563.40	171	760596.20	163
760458.40	175	760489.30	169	760563.46	171	760596.30	163
760458.46	175	760489.40	169	760565.20	171	760596.40	163
760459.20	175	760489.46	169	760566.20	171	760596.46	163
760459.30	175	760521.20	185	760566.30	171	760598.20	163
760459.40	175	760523.20	185	760566.40	171	760603.20	163
760459.46	175	760523.30	185	760566.46	171	760603.30	163
760461.20	169	760525.20	185	760568.20	171	760603.40	163
760461.30	169	760526.20	185	760573.20	171	760603.46	163
760461.40	169	760526.30	185	760573.30	171	760605.46	163
760461.46	169	760526.40	185	760573.40	171	760606.20	163
760463.20	169	760526.46	185	760573.46	171	760606.30	163
760463.30	169	760528.20	185	760575.46	171	760606.40	163

Index of reference numbers

REF	Page	REF	Page	REF	Page	REF	Page
760606.46	163	760666.20	232	760754.40	161	760809.20	177
760607.20	163	760673.20	232	760754.46	161	760809.30	177
760607.30	163	760688.46	253	760755.20	161	760809.40	177
760607.40	163	760689.46	253	760755.30	161	760809.46	177
760607.46	163	760700.20	183	760755.40	161	760812.20	177
760608.20	163	760700.30	183	760755.46	161	760812.30	177
760608.30	163	760700.40	183	760756.20	161	760812.40	177
760608.40	163	760700.46	183	760756.30	161	760812.46	177
760608.46	163	760701.20	183	760756.40	161	760813.46	177
760609.20	163	760701.30	183	760756.46	161	760815.46	177
760609.30	163	760701.40	183	760757.20	161	760821.20	177
760609.40	163	760701.46	183	760757.30	161	760821.30	177
760609.46	163	760702.46	183	760757.40	161	760821.40	177
760613.20	163	760703.20	183	760757.46	161	760821.46	177
760613.30	163	760703.30	183	760759.20	161	760822.20	177
760613.40	163	760703.40	183	760760.20	161	760822.30	177
760613.46	163	760703.46	183	760773.20	234	760822.40	177
760615.46	163	760704.20	183	760773.30	234	760822.46	177
760616.20	163	760704.30	183	760773.40	234	760823.20	177
760616.30	163	760704.40	183	760783.30	234	760823.30	177
760616.40	163	760704.46	183	760783.40	234	760823.40	177
760616.46	163	760706.46	183	760784.30	234	760823.46	177
760617.20	163	760720.40	189	760784.40	234	760824.20	177
760617.30	163	760720.46	189	760785.30	234	760825.20	177
760617.40	163	760721.46	189	760785.40	234	761810.20	173
760617.46	163	760722.40	189	760786.30	234	761810.30	173
760618.20	163	760722.46	189	760786.40	234	761901.20	160
760618.30	163	760730.20	189	760800.20	177	761901.30	160
760618.40	163	760730.30	189	760800.30	177	761902.20	160
760618.46	163	760730.40	189	760800.40	177	761902.30	160
760619.20	163	760730.46	189	760800.46	177	761903.20	161
760619.30	163	760731.46	189	760801.20	177	761903.30	161
760619.40	163	760732.20	189	760801.30	177	761905.20	161
760619.46	163	760732.30	189	760801.40	177	761905.30	161
760620.20	173	760732.40	189	760801.46	177	761907.20	161
760620.30	173	760732.46	189	760802.20	177	761907.30	161
760620.40	173	760739.46	189	760802.30	177	761910.20	165
760620.46	173	760740.20	189	760802.40	177	761910.30	165
760621.20	173	760741.20	189	760802.46	177	761911.20	165
760621.30	173	760742.46	189	760803.20	177	761911.30	165
760621.40	173	760749.46	161	760803.30	177	761912.20	165
760621.46	173	760750.20	161	760803.40	177	761912.30	165
760622.20	173	760750.30	161	760803.46	177	761915.20	167
760622.30	173	760750.40	161	760805.20	177	761915.30	167
760622.40	173	760750.46	161	760805.30	177	761916.20	167
760622.46	173	760751.20	161	760805.40	177	761916.30	167
760623.20	173	760751.30	161	760805.46	177	761917.20	167
760623.30	173	760751.40	161	760806.20	177	761917.30	167
760623.40	173	760751.46	161	760806.30	177	761920.20	177
760623.46	173	760752.20	161	760806.40	177	761920.30	177
760624.20	173	760752.30	161	760806.46	177	761921.20	177
760624.30	173	760752.40	161	760807.20	177	761921.30	177
760624.40	173	760752.46	161	760807.30	177	761922.20	177
760624.46	173	760753.20	161	760807.40	177	761922.30	177
760625.20	173	760753.30	161	760807.46	177	761925.20	179
760625.30	173	760753.40	161	760808.20	177	761925.30	179
760625.40	173	760753.46	161	760808.30	177	761926.20	179
760625.46	173	760754.20	161	760808.40	177	761926.30	179
760663.20	232	760754.30	161	760808.46	177	761927.20	180

Index of reference numbers

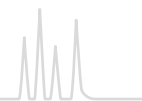

REF	Page	REF	Page	REF	Page	REF	Page
761927.30	180	762007.100	190	762210.210	175	762353.210	163
761931.20	182	762007.210	190	762211.100	175	762353.320	163
761931.30	182	762007.400	190	762211.210	175	762353.400	163
761932.20	183	762010.100	183	762212.400	175	762354.160	163
761932.30	183	762010.210	183	762213.100	175	762354.80	163
761936.20	183	762010.320	183	762213.210	175	762355.320	163
761936.30	183	762010.400	183	762213.320	175	762371.400	177
761937.20	183	762010.500	183	762213.400	175	762372.100	177
761937.30	183	762011.100	183	762214.160	175	762372.210	177
761941.20	187	762011.210	183	762214.80	175	762373.100	177
761941.30	187	762022.100	183	762216.320	175	762373.210	177
761943.30	187	762022.210	183	762220.100	169	762373.320	177
761944.30	187	762022.320	183	762220.210	169	762373.400	177
761951.20	189	762022.400	183	762221.100	169	762375.100	177
761951.30	189	762027.400	183	762221.210	169	762375.210	177
761952.30	189	762029.100	183	762222.400	169	762390.160	177
761953.20	189	762029.210	183	762223.100	169	762390.80	177
761953.30	189	762061.100	183	762223.210	169	762392.320	177
761960.20	185	762061.210	183	762223.320	169	762403.100	165
761960.30	185	762062.100	183	762223.400	169	762403.210	165
761961.20	185	762062.210	183	762224.160	169	762403.320	165
761961.30	185	762062.320	183	762224.80	169	762403.400	165
761962.20	185	762062.400	183	762226.320	169	762404.100	165
761962.30	185	762070.100	161	762230.100	171	762404.210	165
761966.30	190	762070.210	161	762231.100	171	762405.100	165
761967.30	190	762071.100	161	762233.100	171	762405.210	165
761970.20	234	762071.210	161	762233.210	171	762406.400	165
761970.30	234	762072.100	183	762233.320	171	762420.160	165
761971.30	234	762072.210	183	762233.400	171	762420.80	165
761975.20	175	762075.400	190	762234.160	171	762422.320	165
761975.30	175	762077.100	190	762234.80	171	762551.100	180
761976.20	175	762077.210	190	762236.320	171	762551.210	180
761976.30	175	762078.100	190	762250.210	161	762553.210	180
761977.20	175	762078.210	190	762250.400	161	762553.320	180
761977.30	175	762079.400	183	762269.400	167	762553.500	180
761980.20	169	762081.100	161	762271.100	167	762554.100	180
761980.30	169	762081.210	161	762271.210	167	762554.210	180
761981.20	169	762082.210	161	762272.100	167	762555.320	180
761981.30	169	762090.160	183	762272.210	167	762555.400	180
761982.20	169	762090.80	183	762272.320	167	762555.500	180
761982.30	169	762092.160	183	762272.400	167	762556.100	180
761985.20	171	762092.80	183	762273.100	167	762556.210	180
761985.30	171	762094.160	190	762273.210	167	762556.320	180
761986.20	171	762094.80	190	762291.160	167	762556.400	180
761986.30	171	762097.160	161	762291.80	167	762556.500	180
761987.20	171	762097.80	161	762293.320	167	762561.100	180
761987.30	171	762100.400	161	762302.100	183	762561.210	180
761988.20	249	762103.100	161	762302.210	183	762563.210	180
761988.30	249	762103.210	161	762303.400	183	762563.320	180
761989.20	249	762109.100	161	762311.320	183	762563.500	180
761989.30	249	762109.210	161	762311.500	183	762564.100	180
761990.20	163	762113.100	161	762321.320	183	762564.210	180
761990.30	163	762113.210	161	762330.320	190	762565.320	180
761991.20	163	762113.320	161	762350.100	163	762565.400	180
761991.30	163	762113.400	161	762350.210	163	762565.500	180
761992.20	163	762160.160	161	762351.100	163	762566.100	180
761992.30	163	762160.80	161	762351.210	163	762566.210	180
762003.100	183	762163.320	161	762352.400	163	762566.320	180
762003.210	183	762210.100	175	762353.100	163	762566.400	180

Index of reference numbers

REF	Page
762566.500	180
762571.100	180
762571.210	180
762573.210	180
762573.320	180
762573.500	180
762574.100	180
762574.210	180
762575.320	180
762575.400	180
762575.500	180
762576.100	180
762576.210	180
762576.320	180
762576.400	180
762576.500	180
762591.160	180
762591.80	180
762592.320	180
762592.500	180
763132.20	201
763132.30	201
763132.40	201
763132.46	201
763134.20	201
763134.30	201
763134.40	201
763134.46	201
763136.20	201
763136.30	201
763136.40	201
763136.46	201
763138.20	201
763138.30	201
763152.20	201
763152.30	201
763152.40	201
763152.46	201
763154.20	201
763154.30	201
763154.40	201
763154.46	201
763156.20	201
763156.30	201
763156.40	201
763156.46	201
763157.20	201
763157.30	201
763157.40	201
763157.46	201
763158.20	201
763158.30	201
763232.20	203
763232.30	203
763232.40	203
763232.46	203
763234.20	203
763234.30	203
763234.40	203

REF	Page
763234.46	203
763236.20	203
763236.30	203
763236.40	203
763236.46	203
763238.20	203
763238.30	203
763252.20	203
763252.30	203
763252.40	203
763252.46	203
763254.20	203
763254.30	203
763254.40	203
763254.46	203
763256.20	203
763256.30	203
763256.40	203
763256.46	203
763257.20	203
763257.30	203
763257.40	203
763257.46	203
763258.20	203
763258.30	203
763332.20	215
763332.30	215
763332.40	215
763332.46	215
763334.20	215
763334.30	215
763334.40	215
763334.46	215
763336.20	215
763336.30	215
763336.40	215
763336.46	215
763338.20	215
763338.30	215
763432.30	206
763432.46	206
763434.20	206
763434.30	206
763434.40	206
763434.46	206
763436.20	206
763436.30	206
763436.40	206
763436.46	206
763438.20	206
763438.30	206
763532.20	213
763532.30	213
763532.40	213
763532.46	213
763534.20	213
763534.30	213
763534.40	213
763534.46	213

REF	Page
763536.20	213
763536.30	213
763536.40	213
763536.46	213
763538.20	213
763538.30	213
763632.20	211
763632.30	211
763634.20	211
763634.30	211
763634.40	211
763634.46	211
763636.20	211
763636.30	211
763636.40	211
763636.46	211
763638.20	211
763638.30	211
763732.20	208
763732.30	208
763732.40	208
763732.46	208
763734.20	208
763734.30	208
763734.40	208
763734.46	208
763736.20	208
763736.30	208
763736.40	208
763736.46	208
763738.20	208
763738.30	208
801011	297
801013	297
801022	297
801023	297
801053	298
801063	298
801113	297
801123	297
802021	296
802022	296
802023	296
803012	298
803013	298
803022	298
803023	298
804022	299
804023	299
805012	284
805013	284
805014	284
805017	284
805021	284
805022	284
805023	284
805024	284
805032	284
805901	284

REF	Page
805902	284
806013	301
806023	301
807021	296
807023	296
807033	296
808013	297
808023	297
808033	297
808043	297
808053	297
808063	297
808072	297
808073	297
809011	284
809012	284
809013	284
809017	284
809017.200	284
809020	284
809021	284
809022	284
809023	284
809027	284
809027.200	284
809028.100	284
809033	300
809043	300
809051	284
809053	284
809061	284
809063	284
809073	284
809083	284
809121	284
809122	284
809123	284
809210	285
809212	285
809213	285
809217	285
809220	285
809222	285
809223	285
809227	285
810012	287
810013	287
810022	287
810023	287
810043	301
810063	300
810123	287
811011	289
811012	289
811013	289
811021	289
811022	289
811023	289
811032	287

Index of reference numbers

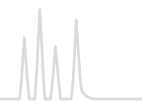

REF	Page	REF	Page	REF	Page	REF	Page
811042	287	814103	303	815360.1	268	817004	302
811051	300	814104	303	815360.25	268	817005	302
811052	291	814200	279	815360.5	268	817006	302
811054	291	814201	279	815380.1	268	817007	302
811055	299	814202	279	815380.25	268	817008	302
811056	299	814203	304	815380.5	268	818023	296
811057	299	814204	279	815381.1	268	818024	296
811058	299	814205	279	815381.25	268	818030.20	284
811059	299	814206	304	815381.5	268	818032	284
811062	291	814300	279	815390.1	268	818033	284
811064	291	814301	279	815390.25	268	818129	284
811071	292	814302	304	815390.5	268	818130.20	284
811072	292	814400	279	815400.1	268	818131	284
811073	292	814401	304	815400.25	268	818132	284
811074	292	814402	304	815400.5	268	818133	284
811075	292	814403	304	815410.1	268	818141	289
811081	292	814404	304	815430.1	268	818143	289
811082	292	814405	279	815510.1	269	818144	292
811111	294	814406	279	815510.5	269	818145	292
811112	294	814407	279	815540.1	269	818146	292
811115	293	814919	304	815540.5	269	818147	292
811116	293	814920	304	815550.1	269	818152	292
811120	295	814921	304	815550.5	269	818153	297
811213	290	814922	304	815560.1	269	818155	297
812003	285	814923	304	815560.5	269	818156	297
812004	285	815010.1	268	815600.1	270	818157	297
812005	285	815010.25	268	815600.5	270	818160	284
812005.200	285	815010.5	268	815610.1	270	818161	284
812006	285	815020.1	268	815610.5	270	818162	284
812007	285	815020.25	268	815620.1	270	818163	284
812008	285	815020.5	268	815620.5	270	818171	292
812010	290	815030.1	268	815650.1	268	818182	294
812011	290	815030.25	268	815650.25	268	818184	293
812013	290	815030.5	268	815650.5	268	818230.20	283
812014	290	815050.1	270	815710.1	269	818232	283
814000	277	815050.25	270	815710.5	269	818233	283
814001	277	815050.5	270	816250.1	305	818240	289
814002	277	815060.1	270	816250.5	305	818241	289
814003	277	815060.25	270	816310.1	305	818261	283
814011	277	815060.5	270	816310.5	305	818329	283
814012	277	815070.1	270	816320.1	305	818330.20	283
814013	277	815300.1	268	816320.5	305	818331	283
814016	303	815300.25	268	816330.1	305	818332	283
814017	303	815300.5	268	816330.5	305	818333	283
814018	303	815310.1	268	816340.1	305	818342	289
814019	303	815310.25	268	816340.5	305	818343	289
814021	303	815310.5	268	816380.1	305	818360	283
814022	303	815320.1	268	816380.5	305	818362	283
814023	303	815320.25	268	816400.1	305	818412	287
814024	303	815320.5	268	816400.5	305	818413	287
814025	279	815330.1	268	816410.1	305	818422	287
814026	279	815330.25	268	816410.5	305	818423	287
814027	279	815330.5	268	816610.1	305	818432	287
814028	279	815340.1	268	816620.1	305	818442	287
814029	277	815340.25	268	816710.01	304	818666	303
814030	303	815340.5	268	816720.01	304	821005	282
814100	279	815350.1	268	817001	302	821010	282, 290
814101	303	815350.25	268	817002	302	821010.200	282
814102	303	815350.5	268	817003	302	821015	282

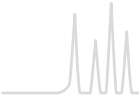

Index of reference numbers

REF	Page
821020	282, 290
821025	282, 290
821030	282
821040	282, 290
821040.200	282
821050	282, 290
821060	282
821110	289
821120	289
821140	289
821150	289
7300009	49
7300009.250	49
7300011	29
7300011.250	29
7300012	29
7300012.250	29
7300014	29
7300014.250	29
7300015	29
7300019	62
7300020	62
7300021	62
7300022	62

List of abbreviations

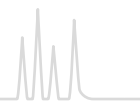

%C	carbon content in percent	LV	large volume
Å	angstrom = 0.1 nm = 1.0×10^{-10} m	MPS	CHROMABOND® SPE cartridges for MultiPurposeSampler
ACN	acetonitrile	MS	mass spectrometry (suitable)
Alox	aluminum oxide	MTBE	methyl <i>tert</i> -butyl ether
AOX	sum parameter for adsorbable organic bounded halogens	N	e.g., N 11, identified the nominal diameter of a bottle neck, an insert, a closure or a septum
ASP	CHROMABOND® SPE cartridges for ASPEC systems	nm	nanometer = 1.0×10^{-9} m
BDS	base deactivated octadecylsilan (C ₁₈)	NP	normal phase
BET	analytical methods for determining of surfaces size (developer: Stephen Brunauer, Paul Hugh Emmett and Edward Teller)	OD	outer diameter
BTEX	aromatic hydrocarbons: benzene, toluene, ethyl benzene and xylene	ODS	octadecylsilan (C ₁₈)
BTX	sum parameter for volatile aromatic hydrocarbons	PA	polyamide, nylon
DIN	German Institute for Standardization	PAH	polycyclic aromatic hydrocarbons
DMA	dimethylamino = N(CH ₃) ₂	PCA	propylcarboxylic acid also butyric acid
DOC	dissolved organic carbon	PCB	polychlorinated biphenyls
DVB	divinylbenzene copolymer	PE	polyethylene
EC	column hardware for analytical columns in HPLC	PEEK	polyether ether ketone
ec	endcapping or endcapped	PEG	polyethylene glycol
EP	European Pharmacopoeia (Ph. Eur., PharmEurl., etc.)	PEI	polyethylenimin
EPA	US Environmental Protection Agency	PL	phospholipids
ETFE	ethylene tetrafluoroethylene	PP	polypropylene
F217	gasket material (foamed polyethylene between two solid polyethylene layers)	ppb	parts per billion (1 per 1000000000 = 10 ⁻⁹)
FEP	fluorinated ethylene propylene	ppm	parts per million (1 per 1000000 = 10 ⁻⁶)
FID	flame ionization detector	PS/DVB	polystyrene divinylbenzene copolymer
FS	fused silica	PSA	propylsulfonic acid
GC	gas chromatography	PTFE	polytetrafluoroethylene
HEPT	height equivalent to a theoretical plate	REF	reference number, article number, product number, ordering number
HILIC	hydrophylic interaction chromatography	RI	refractive index
HPLC	high performance liquid chromatography	RP	reversed phase
HPTLC	high performance thin layer chromatography	SA	strong acidic, also see SCX
HS	headspace	SAX	strong anion-exchanger
ID	internal diameter	SB	strong basic, also see SAX
IR	infrared spectroscopy, spectral range	SCX	strong cation-exchanger
ISO	International Organization for Standardization	SiOH	silanol, unmodified silica
		SPE	solid phase extraction



List of abbreviations

SPME	solid phase micro extraction
TEF	Tefzel [®] , see ETFE
TFA	trifluoroacetic acid
THC	tetrahydrocannabinol
THF	tetrahydrofuran
TLC	thin layer chromatography
TOC	total organic carbon
UHPLC	ultra HPLC, high separation performance by < 2 μ m particles or core-shell technology
UPLC	see UHPLC, but protected term of the company Waters Corporation (USA)
USP	United States Pharmacopeia
UV	ultraviolet wavelength range (e.g., 254 nm), spectral range
VOC	volatile organic compounds
VP	column hardware for preparative columns in HPLC
WCX	weak cation-exchanger

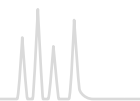

MACHEREY-NAGEL trademarks

ALUGRAM	coated aluminium sheets for TLC
CHROMABOND	columns for solid phase extraction (SPE)
CHROMAFIL	syringe filters (membrane filters)
CHROMAFIX	cartridges for solid phase extraction (SPE)
ChromCart	cartridge system for HPLC
LIPODEX	fused silica capillary columns with cyclodextrin phases for GC enantiomer separation
NUCLEODUR	spherical high purity silica for HPLC
NUCLEOGEL	polymer-based HPLC columns
NUCLEOGEN	HPLC ion exchange columns for nucleic acid analyses
NUCLEOSHELL	core-shell silica phases for HPLC
NUCLEOSIL	spherical standard silica for HPLC
OPTIMA	fused silica high performance capillary columns with immobilized phases
OPTIMA WAXplus	fused silica high performance capillary columns with optimized polyethylene glycol phase
PERMABOND	fused silica capillary columns with immobilized phases
POLYGOSIL	irregular silica for HPLC
POLYGRAM	coated polyester sheets for TLC

Trademarks of other companies

Registered trademarks (®)

Accubond	Agilent Technologies Inc. (USA)	EXTrelut	Merck KGaA (Germany)
Acquity	Waters Corp. (USA)	Fiolax	Schott AG (Germany)
Agilent	Agilent Technologies Inc. (USA)	Florisil	U.S. Silica Co.
Allure	Restek Corp. (USA)	Gemini	Phenomenex Inc. (USA)
Aqua	Phenomenex Inc. (USA)	Hypersil	Thermo Fisher Scientific Inc. (USA)
Ascentis	Sigma-Aldrich Co. (USA)	HyPurity	Thermo Fisher Scientific Inc. (USA)
Atlantis	Waters Corp. (USA)	Inertsil	GL Sciences (Japan)
AutoTrace	Caliper Life Sciences Inc. (USA)	Isco	Teledyne Isco Inc. (USA)
AVICEL	FMC Corp. (USA)	Isolera	isolera GmbH (Germany)
BEKOLut	BEKOLut GmbH & Co. KG (Germany)	Isolute	Biotage AB (Sweden)
Biomek	Beckman Coulter Inc. (USA)	Kromasil	Eka Chemicals AB (Sweden)
Biotage	Biotage AB (Sweden)	LiChrolut	Merck KGaA (Germany)
Bond Elut	Agilent Technologies Inc. (USA) [former Varian Inc. (USA)]	LiChrospher	Merck KGaA (Germany)
Celite	Manville Corp. (USA)	Luna	Phenomenex Inc. (USA)
Cheminert	Valco Instruments Co. Inc. / VICI AG	Metrohm	Deutsche Metrohm GmbH & Co. KG (Germany)
ChiralCel	Daicel Chemical Industries Ltd. (Japan)	Microlab	Hamilton Co. (USA)
ChiralPak	Daicel Chemical Industries Ltd. (Japan)	MultiProbe	PerkinElmer Inc. (USA)
Clean Screen	UCT United Chemical Technologies Inc. (USA)	Oasis	Waters Corp. (USA)
CLEAN-UP	UCT United Chemical Technologies Inc. (USA)	PerkinElmer	PerkinElmer Inc. (USA)
CombiFlash	Teledyne Isco Inc. (USA)	Polaris	Agilent Technologies Inc. (USA)
Companion	Teledyne Isco Inc. (USA)	ProntoSil	Bischoff Chromatography (Germany)
Discovery	Sigma-Aldrich Co. (USA)	Purospher	Merck KGaA (Germany)
Duran	Schott AG (Germany)	Pyrex	Corning Inc. (USA)
epMotion	Eppendorf AG (Germany)	Quadra 3	Tomtec Inc. (USA)
Eurocel	Knauer GmbH (Germany)	RapidTrace	Caliper Life Sciences Inc. (USA)
EVOLUTE	Biotage AB (Sweden)	Rxi	Restek Corp. (USA)
		Rtx	Restek Corp. (USA)
		Sep-Pak	Waters Corp. (USA)

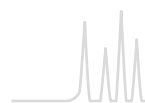

Sigma-Aldrich	Merck KGaA (Germany)	Varian	Varian Medical Systems Technologies Inc. (USA)
SOTAX	Sotax AG (Schweiz)	Vespel	E. I. du Pont de Nemours & Co. (USA)
Spherisorb	Waters Corp. (USA)	VICI	Valco Instruments Co. Inc. / VICI AG
Stabilwax	Restek Corp. (USA)	Viton	DuPont Performance Elastomers (USA)
Styre Screen	UCT United Chemical Technologies Inc. (USA)	Xterra	Waters Corp. (USA)
Superspher	Merck KGaA (Germany)	YMC	YMC Co. Ltd. (Japan)
Supra-Poly	PerkinElmer Inc. (USA)	ZIC	Merck Sequant AB (Sweden)
Symmetry	Waters Corp. (USA)	Zorbax	Agilent Technologies Inc. (USA)
Synergi	Phenomenex Inc. (USA)	Zymark	Caliper Life Sciences Inc. (USA)
Telos	Cole-Parmer Instrument Company, LLC (USA)	Zymate	Caliper Life Sciences Inc. (USA)

Common law trademarks (™)

AmyCoat	Eka Chemicals AB (Sweden)	Hypersil	Thermo Fisher Scientific Inc. (USA)
ASPEC	Gilson Inc. (USA)	HyPURITY	Thermo Fisher Scientific Inc. (USA)
AT	Alltech Associates Inc. (USA)	Kinetex	Phenomenex Inc. (USA)
Bakerbond	Mallinckrodt Baker Inc. (USA)	Lux	Phenomenex Inc. (USA)
Benchmate	Caliper Life Sciences Inc. (USA)	Obelisc	Sielc Technologies (USA)
BPX	SGE Analytical Sciences Pty Ltd. (Australia)	Nukol	Sigma-Aldrich Co. (USA)
Carbowax	Union Carbide Corp. (USA)	PEEK	Victrex plc. (UK)
CelluCoat	Eka Chemicals AB (Sweden)	Porapak	Waters Corp. (USA)
Chem Elut	Agilent Technologies Inc. (USA) [former Varian Inc. (USA)]	Poroshell	Agilent Technologies Inc. (USA)
DB	J&W Scientific Inc. (USA)	SPB	Sigma-Aldrich Co. (USA)
Equity	Sigma-Aldrich Co. (USA)	Select	Agilent Technologies Inc. (USA)
FlashMaster	Biotage AB (Sweden)	Sequant	Merck Sequant AB (Sweden)
Flash 12i	Biotage AB (Sweden)	Strata	Phenomenex Inc. (USA)
Focus	Agilent Technologies Inc. (USA) [former Varian Inc. (USA)]	SunFire	Waters Corp. (USA)
Genesis	Tecan Group AG	Supel	Sigma-Aldrich Co. (USA)
Hydromatrix	Agilent Technologies Inc. (USA) [former Varian Inc. (USA)]	Supelclean	Sigma-Aldrich Co. (USA)
HyperSep	Thermo Fisher Scientific Inc. (USA)	Supelcosil	Sigma-Aldrich Co. (USA)
		Supelcowax	Sigma-Aldrich Co. (USA)
		SymmetryShield	Waters Corp. (USA)

Disclaimer

All used names and denotations can be brands, trademarks or registered labels of their respective owner – also if they do not have a special denotation. To mention products and brands is

only a kind of information, i.e. it does not offend against trademarks and brands and can not be seen as a kind of recommendation or assessment.

Images credits

Cover: rsooll, Alexander Rath, Pixels Hunter
– stock.adobe.com

S.3, 88, 104, 108: Stanistic Vladimir – stock.adobe.com

S.105: Urupong – stock.adobe.com

S.233: Birgit Reitz-Hofmann, economica20, Danny Smythe, jakkapan, fotomek, manla, steve Mcsweeny, bymandesigns
– stock.adobe.com

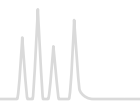

Regarding these products or services we can not grant any guarantees regarding selection, efficiency or operation.

Product use restriction

MACHEREY-NAGEL chromatography products are intended, developed, designed and sold for research and development purposes and analytical quality control / routine measurements only, except, however, any other function of the product being expressly set forth in original MACHEREY-NAGEL product leaflets.

MACHEREY-NAGEL products are intended for general laboratory use only!

MACHEREY-NAGEL products are suited for qualified personnel only!

MACHEREY-NAGEL products shall in any event be used wearing adequate protective clothing.

For detailed information please refer to the respective Material Safety Data Sheet of the product!

MACHEREY-NAGEL products shall exclusively be used in an adequate test environment.

MACHEREY-NAGEL does not assume any responsibility for damages due to improper application, abuse, misuse, storage or maintenance of our products. Prior to application the user has to read carefully and understand the instruction or product leaflets included in the product package (if applicable or available on the webpage) - in case of any doubts the customer has to contact MACHEREY-NAGEL.

Application on the human body is STRICTLY FORBIDDEN. The respective user is liable for any and all damages resulting from such application.

The user has to ensure that the products used are suitable for the intended application.

MACHEREY-NAGEL does not warrant the reproducibility of published applications.

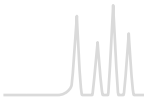
- 
- [1] M. Anastassiades, S. J. Lehotay, D. Stajnbaher, F. J. Schenck, J. AOAC Int. 86 (2003), 412–431.
- [2] AOAC Official Method 2007.01, Pesticide Residues in Foods by Acetonitrile Extraction and Partitioning with Magnesium Sulfate.
- [3] EN 15662:2008 Foods of plant origin – Determination of pesticide residues using GC-MS and/or LC-MS/MS following acetonitrile extraction/partitioning and clean-up by dispersive SPE – QuEChERS method.
- [4] Tanaka, N. et al., Journal of Chromatographic Science, 27 (1989), 721-728.
- [5] LCGC 8 (1990) 378–390.
- [6] U. D. Neue et al., Chromatographia 54 (2001), 169–177.
- [7] A. Alpert, J. Chromatography 499 (1990), 177–196.
- [8] C. S. Young and R. J. Weigand, LCGC 20 (2002), 464–473.
- [9] V. R. Meyer, Practical High Performance Liquid Chromatography (John Wiley & Sons, New York, 3. Aufl., 1999).
- [10] J. J. Kirkland, LCGC 14 (1996), 486–500.
- [11] M. W. Beyerinck, Z. Phys. Chem. 3 (1889), 110.
- [12] Dünnschicht-Chromatographie, 2. Auflage, Springer-Verlag Berlin, 1967.
- [13] H. Jork, Laborpraxis 2 (1992), 110.
- [14] “Proceedings of the International Symposium on Instrumental TLC”, Brighton, Sussex, UK 1989, 105–114.
- [15] H. Jork et al., Dünnschicht-Chromatographie, VCH Verlagsgesellschaft, 1989.
- [16] Planar Chromatography, Vol. 1, ed. R. E. Kaiser, Dr. Alfred Hüthig Verlag, Heidelberg, 1986.
- [17] J. Sullivan, L. Schewe, J. Chromatogr. Sci. 15 (1977), 196–197.
- [18] W. Butte, J. Chromatogr. 261 (1983), 142.
- [19] Thenot et al., Anal. Letters 5 (1972), 217–223, 519–529.
- [20] M. Donike, J. Chromatogr. 85 (1973), 1–7.

Distributed by:



Greyhound Chromatography and Allied Chemicals
6 Kelvin Park
Birkenhead
Merseyside
CH41 1LT
United Kingdom

Tel: +44 (0) 151 649 4000

Fax: +44 (0) 151 649 4001

Email: info@greyhoundchrom.com

Website: www.greyhoundchrom.com

KATEN200001 ChromaCat e1 Da 10 / 0 / 08,2023 PD · Printed in Germany

Chromatography

MACHEREY-NAGEL



Management
System
EN ISO 13485:2016
ISO 9001:2015



www.tuv.com
ID 0000056401